

Technical Data for **PC, PC3, PCR, and PCR3** Single Valve Pressure Controllers



Alicat PC-Series pressure controllers allow the precise control of absolute, gauge or differential pressure. These units can be configured for vacuum pressure or backpressure control.

Tel: 888-290-6060

www.alicat.com/pressure

PCR-Series pressure controllers are best for flows greater than 20 lpm.

PC3 and PCR3-Series pressure controllers are fitted with an external pressure port for sensing and controlling pressures at a remote point in the system.

Standard Specifications (Contact Alicat for available options.)

Performance	PC & PC3 Controllers	PCR & PCR3 Controllers
Full scale pressure < 2" H2O Accuracy	Consult Factory	
Full scale pressure ≥ 2" H2O Standard Accuracy	± 0.25%	
Full scale pressure ≥ 2" H2O High Accuracy Option	± 0.125%	
Repeatability	± 0.08% Full Scale	
Zero Shift and Span Shift	0.02% Full Scale / °Celsius	
Operating Range / Turndown Ratio	0.5% to 100% Full Scale / 200:1 Turndown	
Excess Pressure	102.4% FS Controllable	
Burst Pressure	3 X Full Scale	
Typical Response Time ¹	100 ms (Adjustable)	
Warm-up Time	< 1 Second	

1. Volumes, feed pressures, exhaust pressures and line sizing will determine the limits of response times.

Operating Conditions	PC & PC3 Controllers	PCR & PCR3 Controllers
Gas Compatibility	Compatible with all non-corrosive gases ¹	
Operating Temperature	-10 to +50 °Celsius	
Common Mode Pressure (Differential Pressure Units Only)	150 psig	
Mounting Attitude Sensitivity	None	
Valve Type	Normally Closed	
Ingress Protection	IP40	
Wetted Materials	400 Stainless Steel, 302 & 303 Stainless Steel, Viton®, Silicone RTV, Silicon, Glass. PC & PC3 Only Add: Brass If your application demands a different material, please contact Alicat.	

1. For aggressive gases, please see our PCS and PCRS-Series pressure controllers. For use with water or other liquids please contact Alicat

Communication / Power	PC & PC3 Controllers	PCR & PCR3 Controllers
Monochrome LCD or Color TFT Display with integrated touchpad	Displays Pressure	
Digital Output Signal ¹ Options	RS-232 Serial / RS-485 Serial / PROFIBUS ³	
Analog Output Signal ² Options	0-5 Vdc / 1-5 Vdc / 0-10 Vdc / 4-20 mA	
Optional Secondary Analog Output Signal ²	0-5 Vdc / 1-5 Vdc / 0-10 Vdc / 4-20 mA	
Electrical Connection Options	8 Pin Mini-DIN / 9-pin D-sub (DB9) / 15-pin D-sub (DB15) / 6 pin locking	
Supply Voltage	12-30 Vdc (15-30 Vdc for 4-20 mA outputs)	24-30 Vdc
Supply Current	0.250 Amp	0.750 Amp

1. The **Digital Output Signal** communicates Pressure
 2. The **Analog Output Signal** and **Optional Secondary Analog Output Signal** communicate Pressure
 3. If selecting **PROFIBUS**, no analog signal is available. PROFIBUS units do not have the display. See PROFIBUS specifications for PROFIBUS supply voltages and currents. (www.alicat.com/profibus)

Mechanical Specifications

Pressure Product	Mechanical Dimensions	Process Connections ¹
PC & PC3 Controllers	4.1"H x 3.6"W x 1.1"D	1/8" NPT Female
PCR & PCR3 Controllers	5.5"H x 2.9"W x 5.5"D	3/4" NPT Female

1. Compatible with Beswick®, Swagelok® tube, Parker®, face seal, push connect and compression adapter fittings. VCR and SAE connections upon request.

Standard Available Ranges

PC, PC3, PCR & PCR3 Controllers		
-15 psig to 0 psig		
2 inH ₂ OD	2 inH ₂ OG	
4 inH ₂ OD	4 inH ₂ OG	
1 psid	1 psig	
5 psid	5 psig	
15 psid	15 psig	15 psia
30 psid	30 psig	30 psia
100 psid	100 psig	100 psia
150 psid	300 psig	300 psia
	500 psig*	500 psia*

*Not available on PCR
 Other ranges available. Please contact Alicat.

Select One Unit of Measure when Ordering		
PSIA	inHG	Atm
PSIG	inH ₂ O	Torr
mmHG	mBar	kPa

PC-Series
All standard ranges

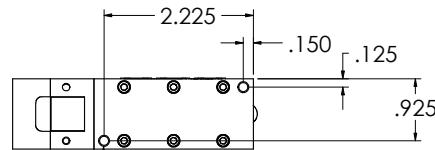
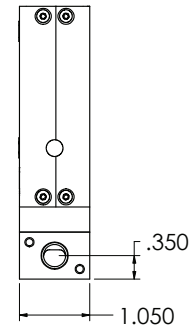
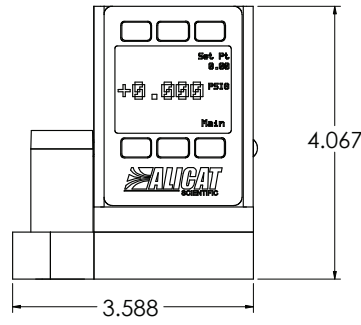
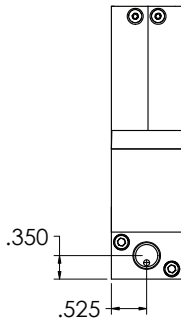
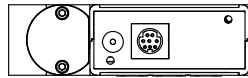

2X 8-32 X .360 ∇ 2 PL

PC-Series
Differential Pressure
All standard ranges

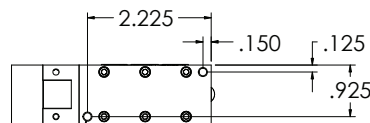
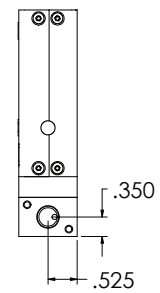
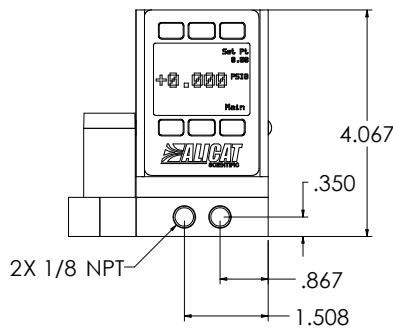
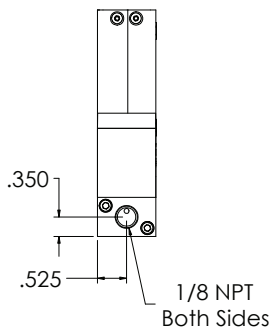
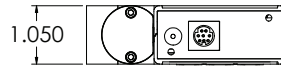

2X 8-32 UNC ∇ .350

PC3-Series
All standard ranges

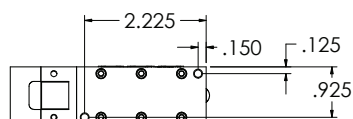
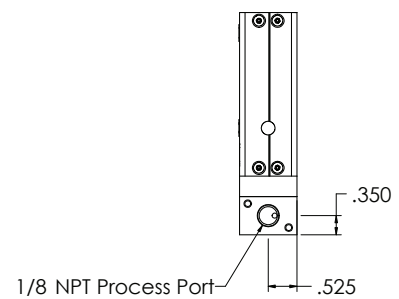
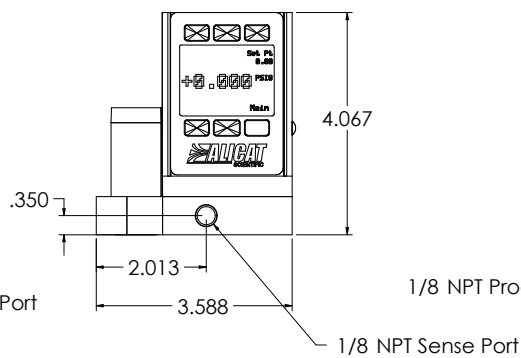
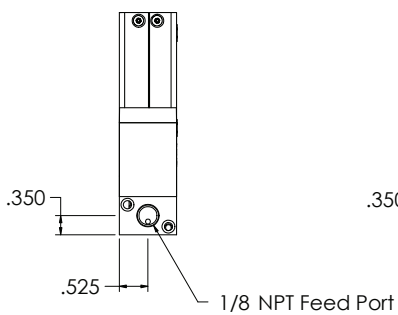
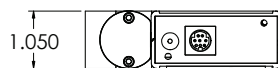

PCR3-Series
All standard ranges

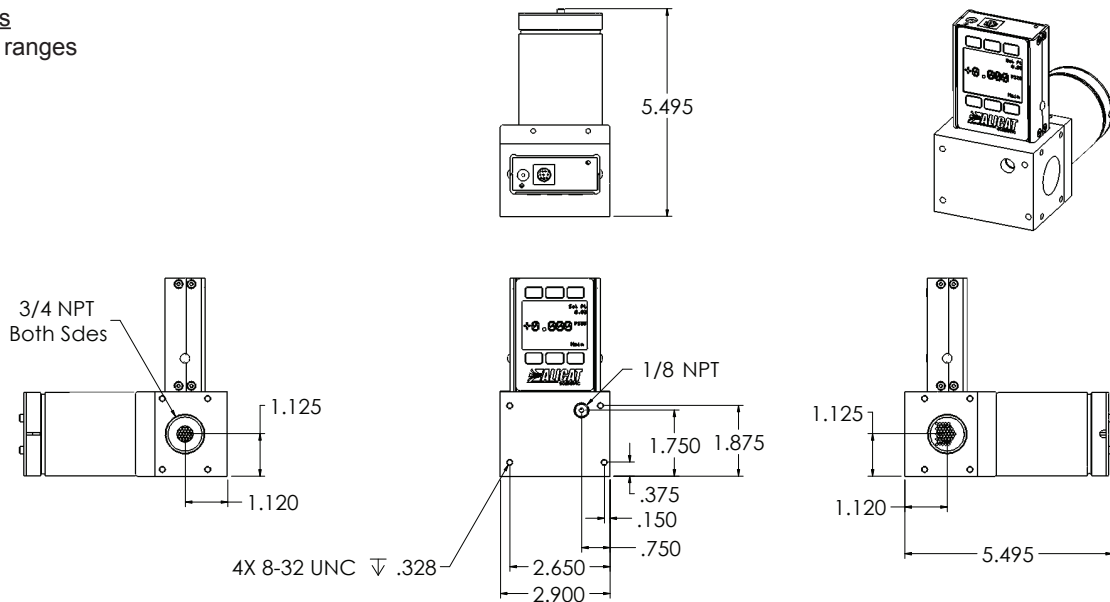

PCR-Series
Most standard ranges

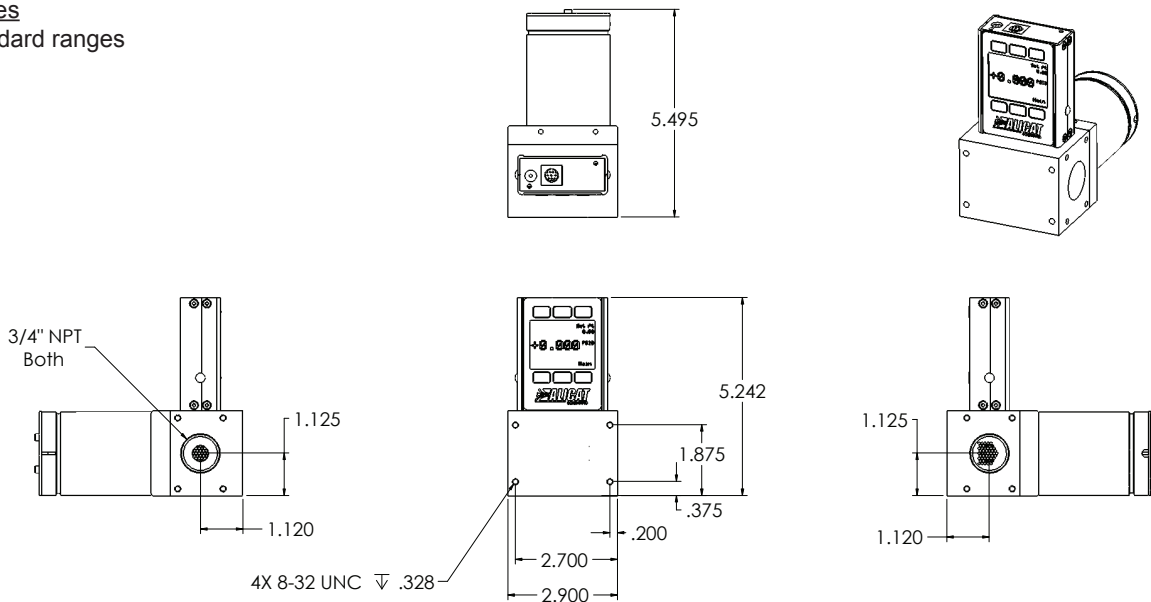

PCR-Series
Differential Pressure 5 inH2O

