



▶ SECTION 3: ACCESSORIES

- A wide selection of fittings and accessories adapt sensors to any installation
- Adjustable fittings with cut-to-length probes provide off-the-shelf versatility
- Choose from a variety of materials to meet your critical environment requirements

Connection heads.....	3-2 to 3-3
Spring-loaded holders.....	3-4
Fluid immersion fittings	3-5
Economy thermowells.....	3-6
HVAC thermowells.....	3-6
Reduced tip thermowells.....	3-7
Tapered thermowells.....	3-7
Flanged thermowells.....	3-8
Bayonet fittings.....	3-9
Extensions.....	3-9
Metric accessories.....	3-10
Feedthroughs.....	3-11
Leadwire and cable seal.....	3-12 to 3-13
Elastomer rubber-filled cable.....	3-14
Extension wire.....	3-15

Connection Heads

Dimensions in inches (mm)		Body/gasket material	IP/NEMA Rating	Max Temp.	Pipe thread codes	Temptran™ models	Approx. weight	Model
CH103 3.5 (89) H 3.5 (89) L 1.9 (48) D 1.9 (48) T		Nickel-plated cast iron with SS chain/silicone gasket	IP55 Type 3 and 4	316°C (600°F)	P1, P2, P3, P4	All models except TT220 and TT221	2.0 lbs. (0.9 kg.)	▼CH103
CH366 3.0 (76) H 3.7 (94) L 1.37 (35) D 1.9 (48) T		White polypropylene (FDA approved)/neoprene gasket	IP55 Type 3 and 4	110°C (230°F)	P3 only	All models except TT220 and TT221	0.2 lbs. (0.1 kg.)	▼CH366
CH359 3.5 (89) H 3.5 (89) L 2.0 (51) D 1.75 (44) T		Aluminum/silicone gasket	IP55 Type 3 and 4	316°C (600°F)	P1, P2, P3, P4	All models except TT220 and TT221	0.8 lbs. (0.4 kg.)	▼CH359
CH301 2.33 (59.2) H 4.25 (108) L 1.25 (31.8) D 3.60 (91.4) T		Aluminum/neoprene gasket	IP55 Type 3 and 4	115°C (240°F)	CH301: P3 only	Miniature TT111 and TT211 models	0.5 lbs. (0.2 kg.)	▼CH301
CH302: P2 only					▼CH302			
CH360 3.5 (89) H 3.5 (89) L 2.0 (51) D 1.75 (44) T		316 SS with silicone gasket	IP56 Type 3, 4 and 4x	316°C (600°F)	P1, P2, P3, P4	All models except TT220 and TT221	1.8 lbs. (0.8 kg.)	▼CH360
CH335/CH339 2.5 (64) Ø 3.5 (89) H 0.95 (20) D		300 series SS with Buna N O-ring	IP56 Type 3, 4 and 4x	121°C (250°F)	P3 only	All models except TT220 and TT221	2.6 lbs. (1.2 kg.)	▼CH335
		300 series SS with Buna N O-ring and chain	IP56 Type 3, 4 and 4x	121°C (250°F)	P3 only	All models except TT220 and TT221	2.6 lbs. (1.2 kg.)	CH339

Dimensions in inches (mm)		Body/gasket material	Hazardous location rating	IP/NEMA Rating	Max Temp.	Approx. weight	Model
Explosionproof/flameproof heads FM/CSA approved							
CH104: 4.60 (116.8) L 3.50 (88.9) H 1.63 (41.4) D 3.35 (85.1) T		Copper-free aluminum/Buna-N O-ring	Division 1; Division 2 Class I, Groups B, C, D; Class II, Groups E, F, G; Class I, Zone 1, AEx d IIC; Zone 1, EX d IIC; T6 (Ta = 40°C), T2 (Ta = 260°C)	IP65 Type 3 and 4	121°C* (250°F)	1.5 lbs. (0.7 kg.)	▼CH104
CH106: 4.20 (106.7) L 3.50 (88.9) H 1.35 (34.3) D 3.22 (81.8) T		Stainless steel/Buna-N O-ring		IP66 Type 3, 4, and 4X	121°C* (250°F)	2.4 lbs. (1.1 kg.)	▼CH106

*Maximum temperature increases to 500°F (260°C) if O-ring is removed. Environmental rating drops to Type 3, IP54.

▼ = STANDARD OPTIONS
Specifications subject to change

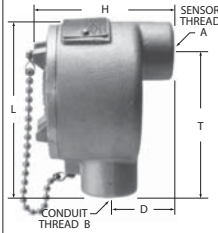
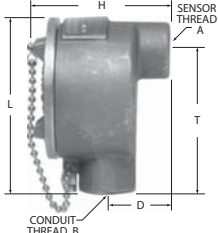
Dimensions in inches (mm)	Body/gasket material	Hazardous location rating	IP/NEMA Rating	Max Temp.	Approx. weight	Model		
Explosionproof heads FM/CSA approved								
CH405/CH407/ CH342/CH343/ CH330/CH328: 4.60 (116.8) L 3.60 (91.4) H 1.63 (41.4) D 3.70 (96.0) T		Copper-free aluminum	Division 1; Class I, Groups A, B, C, D;	IP54 Type 3	260°C (500°F)	CH405		
		Copper-free aluminum/ Buna-N O-ring	Class II, Groups E, F, G; Class III (FM approved only)	IP65 Type 3 and 4	121°C (250°F)	CH407		
		Copper-free aluminum, gray epoxy coat, no chain/ Buna-N O-ring	Division 1; Class I, Groups B, C, D;	IP66 Type 3, 4 and 4X		CH342		
		Copper-free aluminum, gray epoxy coat, with chain/ Buna-N O-ring	Class II, Groups E, F, G;			CH343		
		Note: The following models have lower cost but no FM/CSA approval or label.						
		Aluminum/ Buna-N O-ring	Division 1; Class I, Groups B, C, D;	IP65 Type 3 and 4	121°C (250°F)	1.4 lbs. (0.6 kg.)	CH330	
Aluminum with FDA approved white epoxy coat, no chain/Buna-N O-ring	Class II, Groups E, F, G; Class III	IP66 Type 3, 4 and 4X			CH328			
Flameproof heads CENELEC/ATEX approved Ex II 2G Ex d IIC T6								
CH357/CH358: 4.49 (114) L 3.60 (91.4) H 1.63 (41.4) D 3.78 (96.0) T CH356: 4.20 (106.7) L 3.50 (88.9) H 1.35 (34.3) D 3.22 (81.8) T		Copper-free aluminum/ Buna-N O-ring	Zone 1, Group IIC	IP65 Type 3 and 4	55°C (104°F)	▼ CH357		
		Copper-free aluminum, epoxy coated/Buna-N O-ring	Zone 1, Group IIC	IP66 Type 3, 4 and 4X		CH358		
		Stainless steel/Buna-N O-ring				121°C (250°F)	2.4 lbs. (1.1 kg.)	▼ CH356

Notes:

- View photos of terminal boards under accessories at www.minco.com
- All Temptran™ transmitter models may be used with connection heads on these pages.
 - AC103133 dual miniature Temptran™ mounting kit fits CH104, CH106, and CH356. CH106 and CH356 also require AC103625 modification.
 - AC103528 dual miniature Temptran™ mounting kit fits CH342, CH343, CH405, CH407, CH328, CH330, CH357, and CH358.
 - See Section 4 for more information.

Replacement terminal boards

Model	6-position board	8-position board
CH103	AC103029	AC101926
CH104	AC1039	AC101122
CH106	AC1039	AC101122
CH301	AC101377T6	
CH302	AC101377T6	
CH328	AC1039	AC101122
CH330	AC1039	AC101122
CH331	AC100427	
CH335	AC100427	AC101926
CH339	AC100427	AC101926
CH342	AC1039	AC101122
CH343	AC1039	AC101122
CH356	AC1039	AC101122
CH357	AC1039	AC101122
CH358	AC1039	AC101122
CH359	AC100427	AC101926
CH360	AC100427	AC101926
CH405	AC1039	AC101122
CH407	AC1039	AC101122

Specifications subject to change

Specification and order options

CH104	Model number from table	
P2	Pipe thread code: ▼P1 = $\frac{3}{4}$ - 14 Thread A $\frac{1}{2}$ - 14 Thread B ▼P2 = $\frac{3}{4}$ - 14 $\frac{3}{4}$ - 14 ▼P3 = $\frac{1}{2}$ - 14 $\frac{1}{2}$ - 14 ▼P4 = $\frac{1}{2}$ - 14 $\frac{3}{4}$ - 14 P5 (CH356 only) = $\frac{1}{2}$ - 14 M20 x 1.5 P6 (CH356 only) = $\frac{3}{4}$ - 14 M20 x 1.5	
	T Connection type: ▼T = Terminal board for wires AWG 14 or smaller ▼W = Wire nuts for wires AWG 14 to 22	
	6 Number of terminal posts or wire nuts: ▼: 0, 6 8 (see terminal board table at right for model options) T0: transmitter mounting hardware W0: empty enclosure	
	CH104P2T6 = Sample part number	



Spring-loaded Holders

Exclusive Minco user-friendly design!

Minco's spring-loaded holders provide a quick and simple installation and removal of probe sensors — pull out and twist the knob, insert the probe until it bottoms out, and release the knob.

To remove probe, pull out and twist the knob.

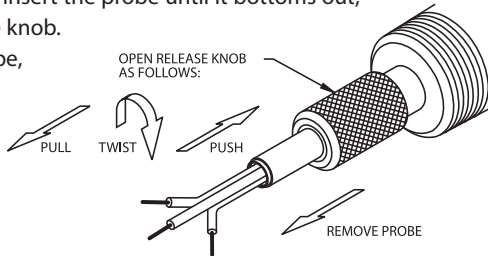

Spring pressure holds the probe tip in contact with the measuring surface for faster response and more reliable measurements. Many models feature a rubber O-ring that doesn't crimp the probe but prevents oil leakage to 50 psi (3.4 bar) at up to 260°C. High temperature models are usable to 450°C. Nylon versions provide electrical insulation.



ALL PARTS STOCKED

Note: Available up to 10 pieces or contact Minco Customer Service

Fluoroelastomer O-ring seal: 50 psi pressure rated fluid seal								
	Body material	Temperature range	Thread "CH"	Process thread	Hex size	Adder "A" (Total length)	Probe Ø inch (mm)	Model
	300 series stainless steel	-40 to 260°C (-40 to 500°F)	3/4 - 14 NPT	1/2 - 14 NPT	1 1/8" (29 mm)	3.6" (91 mm)	0.188 (4.8)	▼ FG114-1
							0.215 (5.5)	▼ FG110-1
							0.250 (6.4)	▼ FG113-1
	316 stainless steel	-40 to 260°C (-40 to 500°F)	3/4 - 14 NPT	1/2 - 14 NPT	1 1/8" (29 mm)	3.6" (91 mm)	0.188 (4.8)	FG914
							0.215 (5.5)	FG912
							0.250 (6.4)	FG911
	Nylon	-40 to 120°C (-40 to 248°F)	3/4 - 14 NPT	1/2 - 14 NPT	1" (25 mm) wrench flats	3.6" (91 mm)	0.188 (4.8)	FG314
							0.215 (5.5)	FG310
							0.250 (6.4)	FG313
	300 series stainless steel	-40 to 260°C (-40 to 500°F)	1/2 - 14 NPT	1/2 - 14 NPT	7/8" (22 mm)	2.6" (66 mm)	0.125 (3.2)	FG216N
							0.188 (4.8)	FG214N
							0.215 (5.5)	FG210N
							0.250 (6.4)	FG213N
							0.236 (6.0)	FG215N
	300 series stainless steel	-40 to 260°C (-40 to 500°F)	None	1/8 - 27 NPT	5/8" (16 mm)	3.6" (91 mm)	2.8" (71 mm)	0.125 (3.2) FG116
							0.188 (4.8)	FG112
							0.215 (5.5)	FG111
							0.250 (6.4)	FG117
	300 series stainless steel	-40 to 260°C (-40 to 500°F)	None	1/4 - 18 NPT	5/8" (16 mm)	1.9" (48 mm)	0.188 (4.8)	FG101072
							0.215 (5.5)	FG101078
							0.250 (6.4)	FG101080

High temperature: No pressure rating or fluid seal								
	Body material	Temperature range	Thread "CH"	Process thread	Hex size	Adder "A" (Total length)	Probe Ø inch (mm)	Model
 (Set screw installation)	300 series stainless steel	-40 to 450°C (-40 to 842°F)	1/2 - 14 NPT	1/2 - 14 NPT	7/8" (22 mm)	2.3" (58 mm)	0.188 (4.8)	▼ FG801
							0.215 (5.5)	▼ FG802
							0.250 (6.4)	▼ FG810

▼ = STANDARD OPTIONS
Specifications subject to change

Fluid Immersion Fittings

Overview

Install probes directly into fluid streams and pressure vessels. Simply position the fitting on the probe and tighten the sealing nut.

Fluid seal fittings are best for moderate temperatures and pressures. Pressure fittings, constructed of stainless steel, can withstand corrosive media and greater extremes of pressure and temperature.

Be sure to check the pressure ratings of probes intended for direct immersion.



ALL PARTS STOCKED

Note: Available up to 10 pieces or contact Minco Customer Service

ACCESSORIES

Fluid seal fittings to 260°C (500°F)						
	Body material	Thread "CH"	Process thread	Adder "A" (Total length)	Probe Ø inch (mm)	Model
	Brass	None	1/8 - 27 NPT	1.2" min. (31 mm)	0.188 (4.8)	▼FG143
		None	1/4 - 18 NPT			▼FG140
		None	1/8 - 27 NPT		0.215 (5.5)	▼FG126
		None	1/4 - 18 NPT			▼FG120
		None	1/8 - 27 NPT		0.250 (6.4)	▼FG151
		None	1/4 - 18 NPT			▼FG130
	Stainless steel	1/2 - 14 NPT	1/2 - 14 NPT	2.4" (61 mm)	0.188 (4.8)	▼FG142
					0.215 (5.5)	▼FG122
					0.250 (6.4)	▼FG132

Note: Fluid seal fittings are rated to 200 psi (17 bar) when using the repositionable silicone rubber O-ring. They are rated to 500 psi (34 bar) when using the non-repositionable compression ring. These fittings come with both the O-ring and the compression ring.

Pressure fittings to 871°C (1600°F)						
	Body material	Thread "CH"	Process thread	Adder "A" (Total length)	Probe Ø inch (mm)	Model
	316 stainless steel	None	1/8 - 27 NPT	1.5" min. (39 mm)	0.188 (4.8)	FG141T3P2
		None	1/4 - 18 NPT			FG141T3P4
		None	1/2 - 14 NPT			FG141T3P8
		None	1/8 - 27 NPT		0.250 (6.4)	FG141T4P2
		None	1/4 - 18 NPT			FG141T4P4
		None	1/2 - 14 NPT			FG141T4P8
	316 stainless steel	1/2 - 14 NPT	1/2 - 14 NPT	2.9" (74 mm)	0.125 (3.2)	FG145T2
					0.188 (4.8)	FG145T3
					0.250 (6.4)	FG145T4

Note: Pressure fittings are rated to 1500 psi (103 bar) at 25°C/77°F, reducing to 500 psi (34 bar) at 630°C/1166°F. The probe cannot be repositioned after installation.

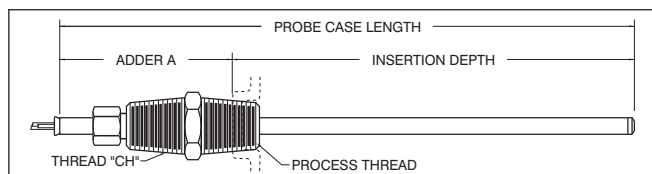

To determine the ideal probe length add the insertion depth to the adder A for the fitting you will use.

▼ = STANDARD OPTIONS
Specifications subject to change



Economy and HVAC Thermowells



Overview

Thermowells protect probes from pressure, flow, and corrosion. The models on this page have integral fittings for probe and connection head mounting.

Immerse the thermowell at least 2.5" (65 mm) for accurate readings. The well should extend beyond the center of the fluid stream without touching the opposite wall. Installation in an elbow or tee may be necessary for sufficient immersion in small pipes.

For fastest time response, Minco can furnish thermowells with heat sink compound in the tip. This eliminates the air gap between the probe and inside wall of the well and can reduce time constant by as much as 50%. Order AC101750.

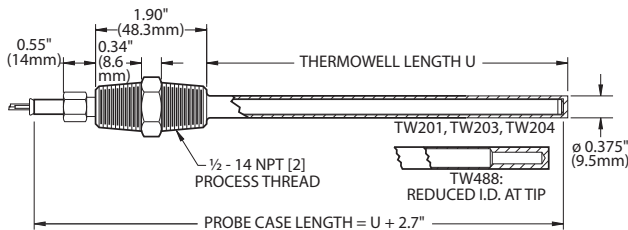

Economy thermowell specifications

Models: TW204 / TW201 / TW203

Probes: use with tip-sensitive probes on pages 2-2 to 2-3

Body material: 300 series stainless steel, nickel-plated brass sealing nut with brass compression ring

Temperature limit: 260°C (500°F)

Pressure rating: 1000 psi (69.9) bar

Hex size: 7/8" (22 mm)

Standard U dimension: 0.1" increments to 48"

Probe diameter	Thread "CH"	Process Thread	Model
0.188" (4.8 mm)	1/2 -14 NPT	1/2 -14 NPT	TW204
0.215" (5.5 mm)			TW201
0.250" (6.4 mm)			TW203

HVAC thermowell specifications

Model: TW488

Probes: use with HVAC probes on page 8-19

Body material: 316 stainless steel, nickel-plated brass sealing nut with silicone rubber O-ring

Temperature limit: 260°C (500°F)

Pressure rating: 1880 psi (129.7) bar

Hex size: 7/8" (22 mm)

Standard U dimension:

3.0, 6.0, 12.0, and 18.0". Other lengths are available.

Probe diameter	Thread "CH"	Process Thread	Model
0.250" (6.4 mm)	1/2 -14 NPT	1/2 -14 NPT	TW488
Tip 0.188" (4.8 mm)			

Specification and order options

TW203	Model number
U	
60	Thermowell length U: Specify in 0.1" increments (Ex: 60 = 6.0 inches)
TW203U60 = Sample part number	



STOCKED PARTS AVAILABLE

▼ = **STANDARD OPTIONS**
Specifications subject to change

Reduced Tip and Tapered Thermowells



Reduced Tip Thermowell



Tapered Thermowell

Overview

Protect probes from pressure, flow, and corrosive fluids. Thermowells on this page are machined from solid bar stock. Specify reduced tip style for fast response, tapered style for maximum rigidity in high flow conditions.

Immerse the thermowell at least 2.5" (65 mm) for accurate readings. The well should extend beyond the center of the fluid stream without touching the opposite wall. Installation in an elbow or tee may be necessary for sufficient immersion in small pipes.

Spring-loaded probe installation is recommended, using either spring-loaded holders or bayonet-mount probes. 0.250" diameter probes provide the best fit.

For fastest time response, Minco can furnish thermowells with heat sink compound in the tip. This eliminates the air gap between the probe and inside wall of the well and can reduce time constant by as much as 50%. Order AC101750.

Contact Minco Sales and Customer Service for other thermowell styles and materials.

Reduced tip thermowell specifications

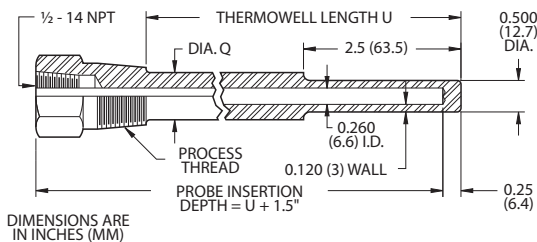

Temperature limit:

Stainless steel: 900°C (1650°F).

Monel: 538°C (1000°F).

Standard U dimensions: 2.5, 4.5, 6.0, 7.5, 8.0, 10.5, 13.5, 16.5, and 22.5". Other dimensions available.

Body material	Process thread (NPT)		
	1/2 - 14	3/4 - 14	1 - 11 1/2
304 stainless steel	TW239	TW228	TW238
316 stainless steel	▼TW222	▼TW248	TW234
Monel	TW1204	TW447	TW1231
Diameter Q	0.625" (16 mm)	0.750" (19 mm)	0.875" (22 mm)
Hex size	1.125" (29 mm)		1.375" (35 mm)

Tapered thermowell specifications

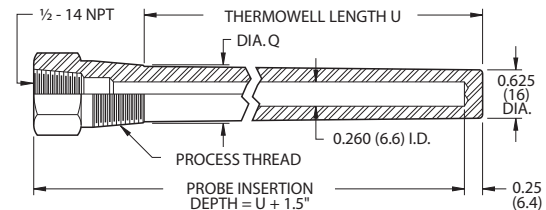

Temperature limit:

Stainless steel: 900°C (1650°F).

Standard U dimensions: 2.5, 4.5, 6.0, 7.5, 8.0, 10.5, 13.5, 16.5, and 22.5". Other dimensions available.

Body material	Process thread (NPT)	
	3/4 - 14	1 - 11 1/2
304 stainless steel	TW477	TW252
316 stainless steel	▼TW1218	▼TW1237
Diameter Q	0.875" (22 mm)	1.06" (27 mm)
Hex size	1.125" (29 mm)	1.375" (35 mm)

Pressure ratings

Body material	Temperature		
	21°C (70°F)	538°C (1000°F)	650°C (1200°F)
304 stainless steel	7000 psi 483 bar	4500 psi 310 bar	1650 psi 114 bar
316 stainless steel	7000 psi 483 bar	5100 psi 352 bar	2500 psi 172 bar
Monel	6500 psi 448 bar	1500 psi 103 bar	

Specification and order options

TW222	Model number from table
U	
45	Thermowell length U: Specify in 0.1" increments (Ex: 45 = 4.5 inches) ▼: 25, 45, 60
TW222U45 = Sample part number	



STOCKED PARTS AVAILABLE

▼ = **STANDARD OPTIONS**

Specifications subject to change

Flanged Thermowells

Overview

Flanged thermowells are available in three standard flange sizes: 1.0", 1.5", and 2.0" per ANSI B16.5. Specify U dimension and pressure rating.

Immerse the thermowell at least 2.5" (65 mm) for accurate readings. The well should extend beyond the center of the fluid stream without touching the opposite wall. Installation in an elbow or tee may be necessary for sufficient immersion in small pipes.

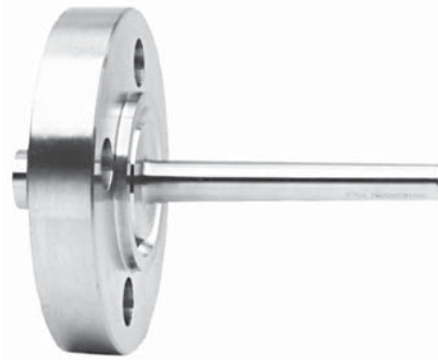

TW1219 Flanged Straight Thermowell

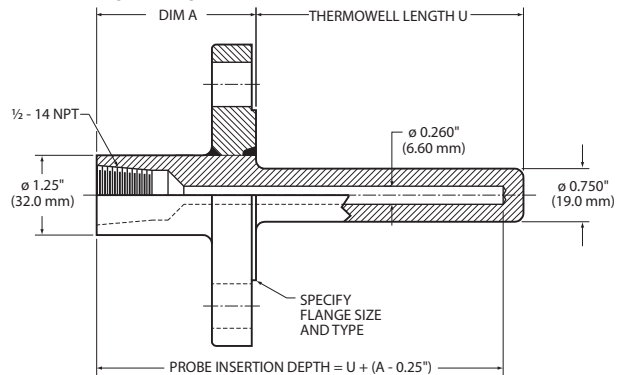

TW1220 Flanged Tapered Thermowell

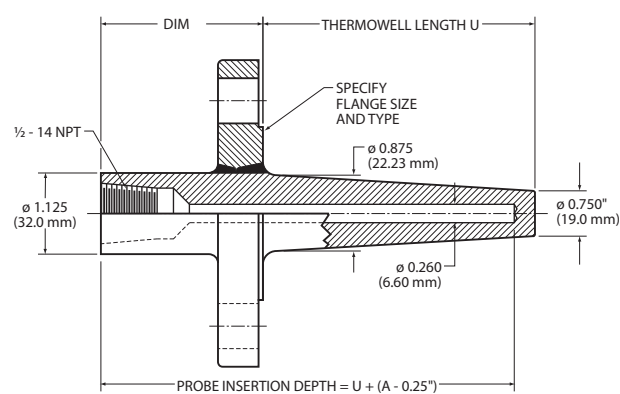

Specifications - Models TW1219 / TW1220

Body material: 316 stainless steel.

Temperature limit: 607°C (1125°F).

Pressure rating: Specify flange pressure rating.
(1 bar = 14.5 psi).

Pressure rating	Dimension A
150, 300, 400, 600 psi	2.25" (64mm)
900, 1500, 2500 psi	3.25" (83mm)

Thread: 1/2-14 NPT internal thread.

Probe diameter: 0.250" (6.4 mm).

Standard U dimensions: 2.5, 4.5, 6.0, 7.5, 8.0, 10.5, 13.5, 16.5, and 22.5". Other dimensions available.

Specification and order options:

TW1219	Model number: TW1219 = Straight TW1220 = Tapered
U	
105	Thermowell length U: Specify in 0.1" increments (Ex: 105 = 10.5 inches)
S	
10	Flange size: 10 = 1.0" 15 = 1.5" 20 = 2.0"
F	
300	Pressure rating in pounds per square inch
RF	Flange type: RF = Raised face RTJ = Ring type joint
TW1219U105S10F300RF = Sample part number	

▼ = **STANDARD OPTIONS**

Specifications subject to change

Bayonet Fittings, Extensions





ALL PARTS STOCKED

Bayonet adapter style

Bayonet fittings are for spring-loaded installation of probes equipped with springs and lockcaps. Insert the probe, hook the lockcap over the pin on the fitting, and release.

Note: Available up to 10 pieces or contact Minco Customer Service

Bayonet adapter style	Body material	Thread "CH"	Process thread	Hex size	Adder "A"	Probe diameter	Model
	303 stainless steel	None	1/8" - 27 NPT	None	1.2" min. (31 mm)	0.188" (4.8 mm)	▼FG180
	316 stainless steel	1/2" - 14 NPT	1/2" - 14 NPT	7/8" (22 mm)	2.4" (61 mm)	0.188" (4.8 mm)	▼FG144T3

Note: Temperature limit: 871°C (1600°F)

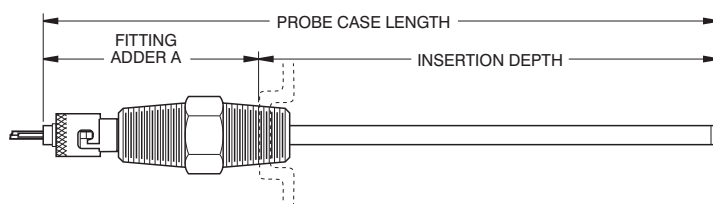

Extension nipples, couplings, unions

Extensions in assemblies serve to isolate connection heads from process connections in order to clear pipe insulation or limit heat conduction into the head. Choose from galvanized or stainless steel nipples, couplings, and unions.

Nipples are short lengths of pipe to extend connection heads away from processes. Couplings and unions have two 1/2" - 14 NPT female threads to join nipples to other fittings. Unions allow installation without rotating the connection head.

Style	Length	Galvanized steel to 260°C (500°F)	Stainless steel to 871°C (1600°F)
 Nipple	1.2" (34 mm)	FG563 Adder C: 0.2" (5mm)	FG537 Adder C: 0.2" (5mm)
	2.0" (51 mm)	▼FG556L20 Adder C: 1.0" (25mm)	▼FG579L20 Adder C: 1.0" (25mm)
	3.0" (76 mm)	▼FG556L30 Adder C: 2.0" (51mm)	▼FG579L30 Adder C: 2.0" (51mm)
	4.0" (102 mm)	▼FG556L40 Adder C: 3.0" (76mm)	▼FG579L40 Adder C: 3.0" (76mm)
	6.0" (152 mm)	▼FG556L60 Adder C: 5.0" (127mm)	▼FG579L60 Adder C: 5.0" (127mm)
 Coupling	Same as Adder B length	▼FG602 Adder B: 1.7" (43mm)	▼FG854 Adder B: 1.4" (36mm)
 Union	Same as Adder B length	▼FG709 (no fluid seal) Adder B: 1.9" (48 mm)	▼FG714 Adder B: 1.6" (41 mm)

Note: All threads are 1/2" - 14 NPT [2].

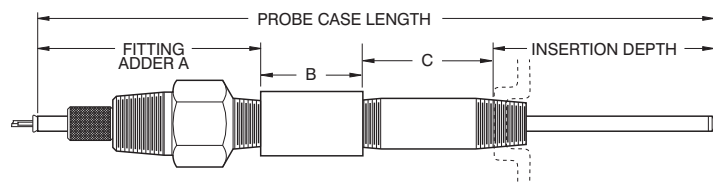

▼ = STANDARD OPTIONS
Specifications subject to change

ACCESSORIES

Metric Accessories

Overview

Metric fittings and thermowells help you design your equipment to meet global standards. Use these fittings to install Minco sensors in process lines, rotating machinery, and all types of industrial equipment.

Special threads and accessories are available. See Eurostyle Sensors Assemblies on page 1-22.





Fluid seal spring-loaded holders: Spring-loaded holders provide fast installation and simple adjustment or removal of probes. Minco's unique designs work with straight probes and provide sealing for the typical oil pressures found in rotating machines.

Fluid seal fittings: Fluid seal fittings are a low cost solution where a connection head is not required.

Bayonet adapters: Bayonet adapters work with Minco's spring-loaded bayonet fitted probes.

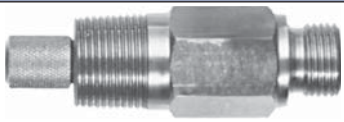
Adapter bushings: Adapter bushings allow fitting 1/2 - 14 NPT fittings into metric threaded process connections.

Thermowells: Thermowells provide high-pressure protection and allow probe replacement without opening the system.

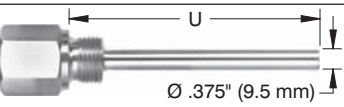
	Body material	Temp. limit	Pressure rating	Thread "CH"	Process thread	Hex size	Probe diameter	Model
 <p>Fluid seal spring-loaded holder Probe length adder A: 3.6" (91mm)</p>	303 series stainless steel per DIN 1.4300, AISI 303	260°C (500°F)	3.4 bar (50 psi)	3/4 - 14 NPT	G 1/2 ISO 229/1 parallel	1 1/16" (27 mm)	0.188" (4.8 mm)	MFG812P477
							0.215" (5.5 mm)	MFG812P546
							0.250" (6.4 mm)	MFG812P635
 <p>Fluid seal fitting Probe length adder A: 1.1" min. (28 mm)</p>	Brass	260°C (500°F)	Silicone rubber O-ring: 17.2 bar (250 psi) Brass compression ring: 34.5 bar (500 psi)	None	R 1/4 ISO 7/1 tapered	9/16" (14 mm)	0.250" (6.4 mm)	MFG816
 <p>Bayonet adapter Probe length adder A: 1.2" (31 mm)</p>	303 series stainless steel per DIN 1.4300, AISI 303	871°C (1600°F)	No fluid seal	None	R 1/8 ISO 7/1 tapered	None	0.188" (4.8 mm)	MFG817
 <p>Adapter bushing Probe length adder A: 1.2" (31 mm)</p>	303 series stainless steel per DIN 1.4300, AISI 303	871°C (1600°F)	No fluid seal	1/2 - 14 NPT (Female)	G 1/2 ISO 229/1 parallel	1 1/16" (27 mm)	All	▼ MFG811
 <p>Thermowell Probe length = U + 30 mm + fitting adder A (U= 13 mm min./1200 mm max.)</p>	303 series stainless steel per DIN 1.4300, AISI 303	871°C (1600°F)	190 bar (2755 psi) at 25°C, reducing to 34 bar (493 psi) at 600°C	1/2 - 14 NPT (Female)	G 1/2 ISO 229/1 parallel	1 1/16" (27 mm)	0.250" (6.4 mm)	MTW1208

Thermowell specification and order options

MTW1208	Model number
U	
100	Thermowell length U: Specify in millimeters Minimum: 13 mm Maximum: 1200 mm
MTW1208U100 = Sample part number	

▼ = STANDARD OPTIONS

Specifications subject to change

Feedthroughs - Prevent Oil Seepage

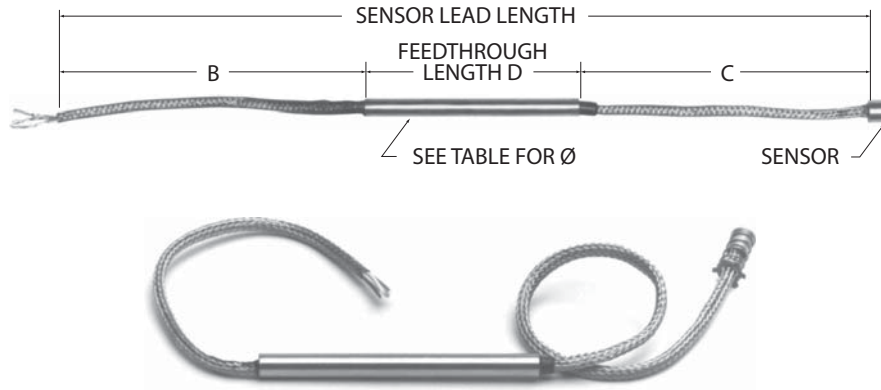

ACCESSORIES

Overview

Feedthroughs provide an oil-tight-seal where a cable exits a machine housing. The stainless steel tube is epoxy filled and each wire is sealed to the individual conductor. This prevents wicking of oil inside the wires as well as leakage around the wire insulation. The pressure rating to 25 psi (1.7 bar) is suitable for most oil and coolant pump systems.

Feedthroughs can be ordered as an accessory to any sensor in this guide. When ordering feedthroughs with case style B bearing sensors, the spring and retaining ring are automatically included. Fluid seal fittings allow easy installation of feedthroughs into standard NPT threaded machine housings. See page 3-4, 3-5 or 3-10 (metric) for fluid seal fittings, or page 3-12 for transitions through housings.

Specifications

Material: Stainless steel with epoxy potting.

Temperature limit: 149°C (300°F).

Pressure limit: 25 psi (1.7 bar).

Sheath Ø	Max. Cable Ø	Model
0.188" (4.8 mm)	0.12" (3.0 mm)	AC958
0.215" (5.5 mm)	0.14" (3.6 mm)	AC717
0.250" (6.4 mm)	0.17" (4.3 mm)	AC718
0.375" (9.5 mm)	0.26" (6.6 mm)	AC961

Specification and order options

AC717	Model number from table
B6	Lead length B or C in inches (specify one): B = Lead end C = Sensor end
D250	Feedthrough length D in 0.01" increments: Min. length: 1.6" (40.6 mm) (Ex: 250 = 2.50")
AC717B6D250 = Sample part number	

▼ = **STANDARD OPTIONS**
Specifications subject to change



FG Series Cable Seals

Prevent oil wicking with bearing embedment sensors



STOP OIL SEEPAGE!

Overview

Minco's FG series cable seals prevent oil wicking with bearing embedment sensors in rotating equipment. They were specifically designed for use with Minco's innovative elastomer filled cables to prevent oil wicking along the sensor cable. FG series seals can also be used to seal around individual leadwires and rigid tubing. The seals include a grommet that provides a tight seal and also allows adjustment of the cable or leadwire position.

Configurations

FG series cable seals are available in three configurations, all of which perform the same basic function of providing an adjustable, oil-tight seal on Minco elastomer filled cables, leadwires, rigid probes or feed-through tubing.

FG1015	FG3015	FG4015
<ul style="list-style-type: none"> • Feed-through grommet 	<ul style="list-style-type: none"> • Split grommet 	<ul style="list-style-type: none"> • Feed-through or split grommet • ATEX and IECEx certified

Installation

The split grommet fits over the cable where access to the cable ends isn't practical. The feed-through grommet requires the cables to be threaded through the grommet. Tightening the fitting compresses the grommet, forming the seal. To adjust the position of the cables in the seal, simply loosen the fitting to decompress the grommet and pull the wire or cable through the grommet to the desired position and retighten the fitting.

Note:

- Plugs are provided to fill unused holes on 6-hole and split grommets.
- Insulated leadwires must be used; do not use bare stranded leadwires.
- Wires must be oil sealed on sensor end.

Specifications

Fitting material	Stainless steel (303 or 316)
Grommet material	Fluoroelastomer or Neoprene
Temperature range (grommet)	Fluoroelastomer: -40 to 90°C (-40 to 194°F) Neoprene: -40 to 75°C (-40 to 167°F)
Pressure	50 psi (3.4 bar) at 20°C
Ingress protection rating*	IP65/IP66
ATEX and IECEx certification*	ATEX II 2 G Ex d e IIc Gb IECEx Ex d e IIc Gb

*FG4014 and FG4015 only

▼ = **STANDARD OPTIONS**

Specifications subject to change

Ordering Information

FG products can be ordered as complete assemblies or as piece parts (fitting body and grommet kit separately).

Cable Seal Assemblies

To configure your assembly, select from the options listed below to determine the complete assembly part number. Use the code shown in **bold** for each selection. Assemblies include fitting body, grommet and compression plugs, and washer (1015).

FG1015	Model number: ▼ FG1015 : Cable seal assembly (feed-through grommet) ▼ FG3015 : Cable seal assembly (split grommet) ▼ FG4015 : Cable seal assembly (feed-through grommet, certified) ▼ FG4015 : Cable seal assembly (feed-through grommet, certified - add S to end of part number for certified version)					
P1	Pipe thread code:					
	Code	Connection thread	Process thread	Overall length	Connection hex size	
	▼ P1	1/2" 14 NPT	3/4" 14 NPT	3.25"	1-1/8"	
	▼ P2	3/4" 14 NPT				
	▼ P3	1/2" 14 NPT	1/2" 14 NPT			
	▼ P4	3/4" 14 NPT				
	P5	NONE	1/2" 14 NPT	2.50"		
	P6		3/4" 14 NPT			
	P7	1/2" 14 NPT (FEMALE)	1/2" 14 NPT	3.25"		
	P8		3/4" 14 NPT			
P9	3/4" 14 NPT (FEMALE)	3/4" 14 NPT	3.35"	1-3/8"		
SS	Fitting material: ▼ SS = Stainless steel, type 303 ST = Stainless steel, type 316					
1V130	Grommet hole quantity, material and size:					
	Hole qty.	Material			Grommet hole Ø	Cable/conductor Ø range
		Neo-prene	Fluoro-elastomer			
		1015, 4015	1015, 4015	3015		
	1		▼ 1V130		0.130"	0.100" to 0.130"
			▼ 1V160	1V160	0.160"	0.130" to 0.160"
			▼ 1V220	1V220	0.220"	0.190" to 0.220"
	2	2N130	▼ 2V130		0.130"	0.100" to 0.130"
		2N160	▼ 2V160		0.160"	0.130" to 0.160"
		2N190	2V190		0.190"	0.160" to 0.190"
	2N220	2V220	2V220	0.220"	0.190" to 0.220"	
3	3N130	3V130		0.130"	0.100" to 0.130"	
		3V160		0.160"	0.130" to 0.160"	
	3N190	3V190	▼ 3V190	0.190"	0.160" to 0.190"	
4			▼ 4V100	0.100"	0.080" to 0.100"	
		▼ 4V130	▼ 4V130	0.130"	0.100" to 0.130"	
		▼ 4V160	▼ 4V160	0.160"	0.130" to 0.160"	
6	6N050	▼ 6V050	▼ 6V050	0.050"	0.030" to 0.050"	
FG1015P1SS1V130 = Sample part number						

Fitting Body/Cap Only

To configure your fitting body/cap, select from the options listed below to determine the complete part number. Use the code shown in **bold** for each selection. Fitting bodies do not include grommet and compression plugs, and washer.

FG1014	Model number: FG1014: Cable seal fitting body only FG4014: Cable seal fitting body only (ATEX)				
P1	Pipe thread code:				
	Code	Connection thread	Process thread	Overall length	Connection hex size
	P1	1/2" 14 NPT	3/4" 14 NPT	3.25"	1-1/8"
	P2	3/4" 14 NPT			
	P3	1/2" 14 NPT	1/2" 14 NPT		
	P4	3/4" 14 NPT			
	P5	NONE	1/2" 14 NPT	2.50"	
	P6		3/4" 14 NPT		
	P7	1/2" 14 NPT (FEMALE)	1/2" 14 NPT	3.25"	
	P8		3/4" 14 NPT		
P9	3/4" 14 NPT (FEMALE)	3/4" 14 NPT	3.35"	1-3/8"	
SS	Fitting material: SS = Stainless steel, type 303 ST = Stainless steel, type 316				
FG1014P1SS = Sample part number					

Grommet Kits

To configure your grommet kit, select from the options listed below to determine the complete part number. Use the code shown in **bold** for each selection. Kits include grommet and compression plugs, and washer (1015).

AC1015	Kit type: AC1015 = Feed-through grommet AC3015 = Split grommet design AC4015 = Feed-through grommet, certified AC4015 = Split grommet design, certified (add S to end of part number to receive split grommet version)					
H1V130	Grommet hole quantity, material and size:					
	Hole qty.	Material			Grommet hole Ø	Cable/conductor Ø range
		Neo-prene	Fluoro-elastomer			
		1015, 4015	1015, 4015	3015		
	H1		1V130		0.130"	0.100" to 0.130"
			1V160	1V160	0.160"	0.130" to 0.160"
			1V220	1V220	0.220"	0.190" to 0.220"
	H2	2N130	2V130		0.130"	0.100" to 0.130"
		2N160	2V160		0.160"	0.130" to 0.160"
		2N190	2V190		0.190"	0.160" to 0.190"
	2N220	2V220	2V220	0.220"	0.190" to 0.220"	
H3	3N130	3V130		0.130"	0.100" to 0.130"	
		3V160		0.160"	0.130" to 0.160"	
	3N190	3V190	3V190	0.190"	0.160" to 0.190"	
H4			4V100	0.100"	0.080" to 0.100"	
		4V130	4V130	0.130"	0.100" to 0.130"	
		4V160	4V160	0.160"	0.130" to 0.160"	
H6	6N050	6V050	6V050	0.050"	0.030" to 0.050"	
AC1015H1V130 = Sample part number						

Specifications subject to change

Note: Order the 6-hole version to seal around PTFE-insulated wires.



Sealed Elastomer Rubber-filled Cable - Prevent Oil Seepage

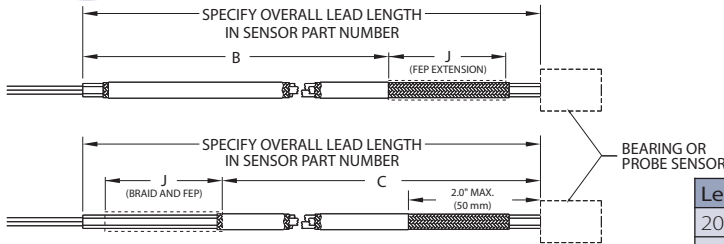
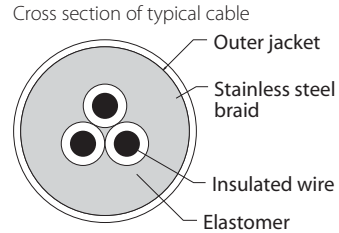

Lead size AWG	Number of leads	Grommet hole Ø
20	2	0.160
24	2	0.130
24	3 and 4	0.160
24	6	0.190
26 - 28	2, 3, 4, and 6	0.130
30	2, 3, and 4	0.100
30	6	0.130

Overview

Model AC100324 is a sensor cable with elastomer fill between the wires, stainless steel braid, and outer jacket. This fill can extend along the entire length of the cable, or a specified portion. Seal the outside of the cable with an FG1015, FG3015 or FG4015 leadwire and cable seal fitting. See page 3-12 for more information.

While the AC100324 provides a good seal, a minuscule amount of oil may escape inside the individual wires.

Specifications

Temperature range: -50° C to 125°C (-58°F to 257°F).

Tolerance on lead length: +1/-0" (+25/-0mm) for lead lengths 24" or less; +5/-0% for lead length greater than 24".

B length: Cable is filled starting at leadwire end of cable. Tubing ends at B length; stainless steel braid extends to case.

C length: Cable is filled starting 2" from case. If J length is specified, stainless steel braid extends to lead end.

J length: Unfilled FEP extension length.

Using the AC100324 with FG1015/FG3015/FG4015 oil seal fittings

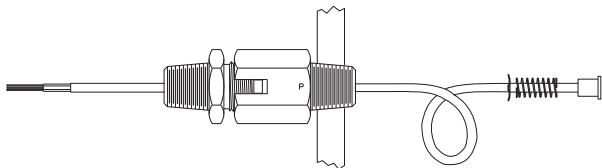

When selecting the FG1015, FG3015 or FG4015 for use with silicone filled cable use the grommet hole size from the tables.

Number of sensing elements	Case style	Grommet hole Ø	
		Leads/RTD	
		2	3
1	A	.130	.160
	B	.130	.160
	C	.130	.130
	D	.100	.100
2	A	.160	.190
	B	.130	.130
	C	.100	.130

Learn more about FG1015, FG3015 or FG4015 leadwire and cable seal fittings on page 3-12.

Specify elastomer filled cables directly in miniature sensor part numbers on pages 6-2 to 6-9 or add to any sensor as part of an assembly.

Specification and order options

AC100324	Model number
B24	Elastomer filled length B or C in inches (if not specified, entire length will be filled) B = Lead end C = Sensor end (Max fill length = 240")
To order standard filled cable, stop here. To order an optional jacket extension add:	
J	Jacket extension
AC100324B24J = Sample part number	

Note: The sensor model number dictates all specifications other than the elastomer filled length B or C and optional extension J. You must specify sensor model including SS braid covering over the leadwires when ordering. Some sensor models do not include the option for SS braid lead covering; contact Minco for assistance with these sensors.

Specifications subject to change

Extension Wire

Overview

Use extension wire and cable to connect sensor leadwires to remote instrumentation. Unless informed otherwise, wire and cable will be supplied in continuous lengths. Ends are not stripped.



ACCESSORIES

Wire for RTDs

Choose single conductor copper wire or cable.

Description	Temperature Limit	Color	Model number for AWG	
			22	26
Single conductor wire, stranded PTFE insulation	260°C (500°F)	White	WS122W	WS126W
		Red	WS122R	WS126R
		Blue	WS122B	WS126B
		Yellow	WS122Y	WS126Y
Single conductor wire, stranded, mica/glass insulation	550°C (1022°F)	White	WS222W	
		Red tracer	WS222R	
3 conductor cable, PTFE insulation, stainless steel braid over all	260°C (500°F)	Red/White/White	WS322S	WS326S
6 conductor cable, PTFE insulation, stainless steel braid over all	260°C (500°F)	Red/White/White/Blue/Yellow/Yellow		WS426S
3 conductor cable, PTFE insulation, copper shield and PTFE jacket over all	260°C (500°F)	Red/White/White	WS522T	

Specification and order options

WS122R	Model number from table
10	Length in feet
WS122R10 = Sample part number	

Single Pair Thermocouple Cable

All thermocouple wire meets standard limits of error per NBS (NIST) Monograph 175, based on ITS-90.

Description	Temperature Limit	Model number for AWG	
		20	24
Single pair thermocouple cable, glass braid insulation	482°C (900°F)	WT120G	WT124G
Single pair thermocouple cable, PTFE insulation	260°C (500°F)	WT120T	WT124T
Single pair thermocouple cable, glass braid insulation with stainless steel braid over all	482°C (900°F)	WT120S	WT124S

Specification and order options

WT120S	Model number from table
J	Junction type: E, J, K, or T
25	Length in feet
WT120SJ25 = Sample part number	

▼ = STANDARD OPTIONS
Specifications subject to change

