



▶ SECTION 6: MINIATURE SENSORS

- Embedment sensors install in bearings for over-temperature protection
- Small, rugged RTDs and thermocouples withstand rough handling and harsh environments
- Certified non-sparking sensors for hazardous areas
- Bolt-on designs for easy installation

Embedment RTDs.....	6-2
Embedment Thermocouples.....	6-3
Increased Safety and Intrinsically Safe Embedment Sensors	6-4 to 6-5
Non-sparking Embedment Sensors	6-6 to 6-9
Bolt-on sensors	6-10
Economy sensors.....	6-11
Installation and accessories	6-12

Embedment RTDs

Element	TCR $\Omega/\Omega/^{\circ}\text{C}$	Case style A		Case style B		Case style C		Case style D	
		Single	Dual	Single	Dual	Single	Dual	Single	Dual
Platinum, 100 Ω $\pm 0.36\%$ at 0°C	.00392	S325PA, S11636PA*	S4026PA	S331PA	S7792PA	S341PA	S14320PA	S12414PA	
Platinum, 100 Ω $\pm 0.12\%$ at 0°C (Meets EN60751, Class B)	.00385	S304PD	S309PD	S306PD	S14405PD	S308PD	S14455PD	▼ S13282PD	
Platinum, 100 Ω $\pm 0.36\%$ at 0°C	.00385	S7304PE	S305PE	S7746PE	S307PE	S7908PE	S14456PE	S13282PE	
Platinum, 1000 Ω $\pm 0.12\%$ at 0°C	.00385	S101907PF	S101911PF	S101908PF	S101912PF	S101909PF	S101913PF	S101910PF	
Copper, 10 Ω $\pm 0.2\%$ at 25°C	.00427	S324CA	S4026CA	S332CA		S342CA			
Nickel, 120 Ω $\pm 0.5\%$ at 0°C	.00672	S326NA, S11636NA*	S4026NA	S330NA	S7792NA	S340NA			

*MIL-T-24388C qualified models

Overview

Install miniature sensors in or beneath the babbitt layer of bearing shoes. They monitor metal temperature — the most reliable indicator of bearing condition — to give early warning of oil film breakdown. Machines can then be shut down and the problem corrected before catastrophic failure occurs.

While no larger than many bare ceramic elements, these RTDs have metal cases and insulated leads to withstand rough handling and harsh environments. They are easy to install in drilled holes for general purpose sensing.

Specifications

Temperature range: -50 to 260°C (-58 to 500°F).

Case: Tin plated copper alloy. Models S12414, S13282 and S101910: Stainless steel.

Babbitt tip: Factory applied babbitt tip, available on case style A or B, reduces the danger of overheating the sensor when installed in babbitt layer.

Leads: Stranded copper with PTFE insulation; stainless steel overbraid optional (one sleeve covers all leads). Polyimide insulation available on selected models (See specification and order options).

Time constant: 3.0 seconds (case style A) to 1.5 seconds (case style D), typical value in moving water.

Insulation resistance: 10 megohms min. at 100 VDC, leads to case.

*MIL-T-24388C qualified models:

PRT-EM-E2: Order S11636PA3K36B1.

NRT-EM-E1: Order S11636NA3K36B1.

▼ = **STANDARD OPTIONS**

Specifications subject to change

Leadwire size (AWG):

Case style	Number of leads			
	2	3	4	6
A	24	24	24	24
B	24	24	28	28
C	24	26	30	30
D	30	30	34	



STOP OIL SEEPAGE!



STOCKED PARTS AVAILABLE

Specification and order options

S331PA	Model number from table
3	Number of leads per sensing element (2, ▼3, or 4): ▼:3 CA or PD elements not available with 2 leads. 4 leads available on single elements and S14405 only.
S	Covering over leadwires: ▼ T = PTFE insulated leads only ▼ S = Stainless steel overbraid with PTFE insulated leads F = FEP over PTFE insulated leads R = FEP over stainless steel braid and PTFE insulated leads. E = FEP over stainless steel braid, with elastomer fill and PTFE insulated leads. (max fill length 240") S11636 Covering options only: K = Polyimide insulated leads. S = Stainless steel overbraid with polyimide insulated leads.
120	Lead length in inches: ▼120
(Stop here for case style C or D; no installation variable)	
AC1	Optional Installation/Accessory option: B0 = No babbitt metal or accessories B1 = Babbitt metal applied AC1 = Supplied with AC171 spring and AC172 series ring (case style B only) AC2 = Supplied with AC171 spring and AC1038 ring (case style B only) AC3 = Supplied with AC171 spring and AC915-1 ring (case style B only)
S331PA3S120AC1 = Sample part number	

Embedment Thermocouples

Leadwire	Case style A Case L: 0.250" (6.4 mm) Case Ø: 0.275" (7.0 mm)		Case style B Case L: 0.250" (6.4 mm) Case Ø: 0.188" (4.8 mm) Flange Ø: 0.250" (6.4 mm)		Case style C Case L: 0.300" (7.6 mm) Case Ø: 0.125" (3.2 mm)		Case style D Case L: 0.300" (7.6 mm) Case Ø: 0.080" (2.0 mm)	
	Single	Dual	Single	Dual	Single	Dual	Single	Dual
AWG 20 stranded	TC311	TC312	TC333					
AWG 24 stranded	TC2162	TC2303	TC2084	TC2096	TC344	TC2623		
AWG 24 stranded with single SS braid over both wire pairs		TC2698		TC2520		TC2837		
AWG 30 solid							▼TC2741	

Overview

These thermocouples are mechanically interchangeable with the RTDs on pages 6-2 and 6-3.

Specifications

Temperature range: -184 to 260°C (-300 to 500°F).

Copper-Constantan (Type T):

AWG 24: 200°C (392°F) maximum,

AWG 30: 150°C (302°F) maximum.

Time constant: Typical value in moving water:

Grounded junction: 0.3 seconds.

Ungrounded junction: 6 seconds (case style A) to 1 second (case style C).

Insulation resistance: 10 megohms min. at 100 VDC, leads to case, ungrounded junctions only.

Case: Tin plated copper alloy.

Babbitt tip: Factory applied babbitt tip, available on case styles A and B, reduces the danger of overheating the sensor when installed in babbitt layer.

Leads: See table for sizes and options. Dual element models with AWG 24 stranded leadwires are available with a single stainless steel braid over all four wires. This option is recommended for use with integral feedthroughs. See below for more information.

Specification and order options

TC311	Model number from table
E	Junction type: ▼ E = Chromel-Constantan ▼ K = Chromel-Alumel ▼ J = Iron-Constantan ▼ T = Copper-Constantan
U	Junction grounding: ▼ G = Grounded ▼ U = Ungrounded
36	Lead length in inches ▼: 48, 144
S	Covering over leadwires: T = PTFE insulated leads only ▼ S = Stainless steel overbraid with PTFE insulated leads F = FEP over PTFE insulated leads R = FEP over stainless steel braid and PTFE insulated leads E = FEP over stainless steel braid, with elastomer fill and PTFE insulated leads (max fill length 240")
(Stop here for case style C or D; no installation variable)	
B0	Optional Installation/Accessory option: B0 = No babbitt metal or accessories B1 = Babbitt metal applied AC1 = Supplied with AC171 spring and AC172 series ring (case style B only) AC2 = Supplied with AC171 spring and AC1038 ring (case style B only) AC3 = Supplied with AC171 spring and AC915-1 ring (case style B only)
TC311EU36SB0 = Sample part number	

STOP OIL SEEPAGE!

Feedthroughs provide an oil tight seal where a cable exits a machine housing. The stainless steel tube is epoxy filled and each wire is sealed to the individual conductor. This prevents wicking of oil inside the wires as well as leakage around the wire insulation. Pressure rating to 25 psi (1.7 bar.) See page 3-11 for details.

Leadwire and cable seal models FG1015, FG3015 and FG4015 seal RTD or thermocouple leadwires where they exit oil-filled bearing housings of rotating equipment. Both versions include a grommet that provides the seal and allows adjustment of the wire or cable position. See page 3-12 for details.

Elastomer rubber-filled cable has elastomer fill between the wires, stainless steel braid, and outer jacket. This fill can extend along the entire length of the cable, or a specified portion. The outside of the cable can be sealed with an FG1015, FG3015 and FG4015 fitting. See Leadwire Covering Options on Miniature Sensors on pages 6-2 to 6-10.

For more information on the problems of oil seepage and various solutions, visit www.minco.com



▼ = STANDARD OPTIONS
Specifications subject to change

Increased Safety & Intrinsically Safe Embedment Sensors

ATEX  **II 2 G Ex e IIC**

ATEX  **II 1 G Ex ia IIC**

IECEX Ex eb IIC

IECEX Ex ia IIC

EAC



Overview

- Increased safety and intrinsically safe embedment sensors for monitoring the temperature of thrust bearings
- Three case styles offer a variety of installation options
- Certified for use in Zone 0 and Zone 1, Group IIC hazardous areas, defined by IEC 60079-0 and IEC 60079-7

Specifications

Temperature range: -50 to 200°C (-58 to 392°F), reducing to 125°C (257°F) when elastomer filled cable is ordered.

Case: Tin plated copper alloy.

Babbitt tip: Factory applied babbitt tip, available on case style A and B reduces the danger of overheating the sensor when installed in babbitt layer.

Leads:

RTD: stranded copper with PTFE insulation.

Stainless steel braid, FEP over PTFE and FEP over stainless steel braid with elastomer fill are optional.

Thermocouple: stranded, PTFE insulated, twisted pairs.

Stainless steel braid, FEP over PTFE and FEP over stainless steel braid with elastomer fill are optional.

Leadwire size (AWG):

RTD					
Case style	Number of leads				
	2	3	4	6	8
A	24	24	24	24	
B	24	24	28	28	28
C	24	26	30	30	
D	30	30	34		
Thermocouple					
A, B, C	24		24		
D	30				

Time constant: 3.0 seconds (case style A), typical in moving water.

Insulation resistance: 10 megohms minimum at 100 VDC, leads to case.

▼ = **STANDARD OPTIONS**





Specifications subject to change





Specification and order options: RTD

S102951PD	Model number from next page
3	Number of leads per sensing element (2, 3 or 4): ▼:3 CA or PD elements not available with 2 leads 4 leads available on all single elements and dual S207596 + S207598 only
E	Covering over leadwires: T = PTFE insulated leads only ▼ S = Stainless steel overbraid with PTFE insulated leads F = FEP over PTFE insulated leads ▼ E = FEP over stainless steel braid, with elastomer fill and PTFE insulated leads (max. fill length 240")
36	Lead length in inches ▼:36, 120
(Stop here for case style C; no installation variable)	
AC1	Optional Installation/Accessory option ▼ B0 = No babbitt metal or accessories ▼ B1 = Babbitt metal applied ▼ AC1 = Supplied with AC171 spring and AC172 series ring (case style B only) AC2 = Supplied with AC171 spring and AC1038 ring (case style B only) AC3 = Supplied with AC171 spring and AC915-1 ring (case style B only)
S102951PD3E36AC1 = Sample part number	

Specification and order options: Thermocouple

TC102960K	Model number from next page
U	Junction grounding: ▼ G = Grounded ▼ U = Ungrounded
48	Lead length in inches ▼:48, 144
S	Covering over leadwires: T = PTFE insulated leads only ▼ S = Stainless steel overbraid with PTFE insulated leads F = FEP over PTFE insulated leads ▼ E = FEP over stainless steel braid, with elastomer fill and PTFE insulated leads (max fill length 240")
(Stop here for case style C; no installation variable)	
B0	Optional Installation/Accessory option ▼ B0 = No babbitt metal or accessories ▼ B1 = Babbitt metal applied ▼ AC1 = Supplied with AC171 spring and AC172 series ring (case style B only) AC2 = Supplied with AC171 spring and AC1038 ring (case style B only) AC3 = Supplied with AC171 spring and AC915-1 ring (case style B only)
TC102960KU48SB0 = Sample part number	

RTD Element	TCR $\Omega/\Omega/^{\circ}\text{C}$	Case style A Case L: 0.250" (6.4 mm) Case \varnothing : 0.275" (7.0 mm) 		Case style B Case L: 0.250" (6.4 mm) Case \varnothing : 0.188" (4.8 mm) Flange \varnothing : 0.250" (6.4 mm) 		Case style C Case L: 0.300" (7.6 mm) Case \varnothing : 0.125" (3.2 mm) 		Case style D Case L: 0.300" (7.6 mm) Case \varnothing : 0.080" (2.0 mm) 
		Single	Dual	Single	Dual	Single	Dual	Single
▼ Platinum, 100 Ω \pm 0.36% at 0°C	.00392	S102950	S102950	S102951	S102951	S102952	S102952	S102954 * Zone 0 only
▼ Platinum, 100 Ω \pm 0.12% at 0°C (Meets EN60751, Class B)	.00385							
▼ Platinum, 100 Ω \pm 0.067% at 0°C (Meets EN60751, Class A)	.00385							
▼ Platinum, 100 Ω \pm 0.36% at 0°C	.00385							
▼ Platinum, 1000 Ω \pm 0.12% at 0°C	.00385							
▼ Copper, 10 Ω \pm 0.2% at 25°C	.00427							
▼ Nickel, 120 Ω \pm 0.5% at 0°C	.00672							Not Available

Thermocouple Junction Type	Case style A Case L: 0.250" (6.4 mm) Case \varnothing : 0.275" (7.0 mm) 		Case style B Case L: 0.250" (6.4 mm) Case \varnothing : 0.188" (4.8 mm) Flange \varnothing : 0.250" (6.4 mm) 		Case style C Case L: 0.300" (7.6 mm) Case \varnothing : 0.125" (3.2 mm) 		Case style D Case L: 0.300" (7.6 mm) Case \varnothing : 0.080" (2.0 mm) 
	Single	Dual	Single	Dual	Single	Dual	Single
E = Chromel-Constantan	▼ TC102960	▼ TC102960	▼ TC102961	▼ TC102961	TC102962	TC102962	TC102964 *Zone 0 only
J = Iron-Constantan							
K = Chromel-Alumel							
T = Copper-Constantan							

STOP OIL SEEPAGE!

Feedthroughs provide an oil tight seal where a cable exits a machine housing. The stainless steel tube is epoxy filled and each wire is sealed to the individual conductor. This prevents wicking of oil inside the wires as well as leakage around the wire insulation. Pressure rating to 25 psi (1.7 bar.) See page 3-11 for details.

Leadwire and cable seal models FG1015, FG3015 and FG4015 seal RTD or thermocouple leadwires where they exit oil-filled bearing housings of rotating equipment. Both versions include a grommet that provides the seal and allows adjustment of the wire or cable position. See page 3-12 for details.

Elastomer rubber-filled cable has elastomer fill between the wires, stainless steel braid, and outer jacket. This fill can extend along the entire length of the cable, or a specified portion. The outside of the cable can be sealed with an FG1015, FG3015 and FG4015 fitting. See Leadwire Covering Options on Miniature Sensors on pages 6-2 to 6-10.



Minco Application Aid #27 provides more information on the problems of oil seepage and various solutions. Download AA#27 at www.minco.com

▼ = STANDARD OPTIONS
Specifications subject to change

Non-sparking Embedment Sensors - Self Certified



ATEX
II 3 G Ex nA IIC u



Overview

- Non-sparking embedment sensors for monitoring the temperature of thrust bearings
- Four case styles offer a variety of installation options
- Certified for use in Zone 2, Group IIC hazardous areas

Specifications

Temperature range: -50 to 200°C (-58 to 392°F), reducing to 125°C (257°F) when elastomer filled cable is ordered.

Case: Tin plated copper alloy.

Babbitt tip: Factory applied babbitt tip, available on case style A, B, and short style B, reduces the danger of overheating the sensor when installed in babbitt layer.

Leads:

RTD: stranded copper with PTFE insulation.

Stainless steel braid, FEP over PTFE and FEP over stainless steel braid with elastomer fill are optional.

Thermocouple: stranded, PTFE insulated, twisted pairs.

Stainless steel braid, FEP over PTFE and FEP over stainless steel braid with elastomer fill are optional.

Leadwire size (AWG):

RTD					
Case style	Number of leads				
	2	3	4	6	8
A	24	24	24	24	
B	24	24	28	28	28
C	24	26	30	30	
Short B	24	26	28	30	
Thermocouple					
All cases	24		24		

Time constant: 3.0 seconds (case style A), typical in moving water.

Insulation resistance: 10 megohms minimum at 100 VDC, leads to case.

▼ = **STANDARD OPTIONS**

Specifications subject to change





Specification and order options:



RTD

S102617PD	Model number from next page
3	Number of leads per sensing element (2, 3 or 4): CA or PD elements not available with 2 leads 4 leads available on all single elements and dual S102618 and S102662 only
F	Covering over leadwires: T = PTFE insulated leads only S = Stainless steel overbraid with PTFE insulated leads F = FEP over PTFE insulated leads E = FEP over stainless steel braid with elastomer fill and PTFE Insulated leads (max. fill length 240")
48	Lead length in inches
(Stop here for case style C or D; no installation variable)	
B0	Optional Installation/Accessory option: B0 = No babbitt metal or accessories B1 = Babbitt metal applied AC1 = Supplied with AC171 spring and AC172 series ring (case style B only) AC2 = Supplied with AC171 spring and AC1038 ring (case style B only) AC3 = Supplied with AC171 spring and AC915-1 ring (case style B only)
S102617PD3F48B0 = Sample part number	

Thermocouple

TC102621E	Model number from next page
U	Junction grounding: G = Grounded U = Ungrounded
48	Lead length in inches
F	Covering over leadwires: T = PTFE insulated leads only S = Stainless steel overbraid with PTFE insulated leads F = FEP over PTFE insulated leads E = FEP over stainless steel braid with elastomer fill and PTFE Insulated leads (max. fill length 240")
(Stop here for case style C or D; no installation variable)	
B0	Optional Installation/Accessory option: B0 = No babbitt metal or accessories B1 = Babbitt metal applied AC1 = Supplied with AC171 spring and AC172 series ring (case style B only) AC2 = Supplied with AC171 spring and AC1038 ring (case style B only) AC3 = Supplied with AC171 spring and AC915-1 ring (case style B only)
TC102621EU48FB0 = Sample part number	

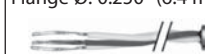
RTD Element	TCR $\Omega/\Omega/^{\circ}\text{C}$	Case style A Case L: 0.250" (6.4 mm) Case \varnothing : 0.275" (7.0 mm) 		Case style B Case L: 0.250" (6.4 mm) Case \varnothing : 0.188" (4.8 mm) Flange \varnothing : 0.250" (6.4 mm) 		Case style C Case L: 0.300" (7.6 mm) Case \varnothing : 0.125" (3.2 mm) 		Short case style B Case L: .188" (4.8 mm) Case \varnothing : .188" (4.8 mm) Flange \varnothing : 0.250" (6.4 mm) 	
		Single	Dual	Single	Dual	Single	Dual	Single	Dual
Platinum, 100 Ω \pm 0.36% at 0°C	.00392	S102617PA	S102617PAPA	S102618PA	S102618PAPA	S102619PA	S102619PAPA	S102662PA	S102662PAPA
Platinum, 100 Ω \pm 0.12% at 0°C (Meets EN60751, Class B)	.00385	S102617PD	S102617PDPD	S102618PD	S102618PDPD	S102619PD	S102619PDPD	S102662PD	S102662PDPD
Platinum, 100 Ω \pm 0.36% at 0°C	.00385	S102617PE	S102617PEPE	S102618PE	S102618PEPE	S102619PE	S102619PEPE	S102662PE	S102662PEPE
Platinum, 1000 Ω \pm 0.12% at 0°C	.00385	S102617PF	S102617PFPF	S102618PF	S102618PFPF	S102619PF	S102619PFPF	S102662PF	S102662PFPF
Copper, 10 Ω \pm 0.2% at 25°C	.00427	S102617CA	S102617CACA	S102618CA		S102619CA		S102662CA	
Nickel, 120 Ω \pm 0.5% at 0°C	.00672	S102617NA	S102617NANA	S102618NA	S102618NANA	S102619NA		S102662NA	S102662NANA

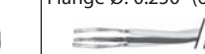
Thermocouple Junction Type	Case style A Case L: 0.250" (6.4 mm) Case \varnothing : 0.275" (7.0 mm) 		Case style B Case L: 0.250" (6.4 mm) Case \varnothing : 0.188" (4.8 mm) Flange \varnothing : 0.250" (6.4 mm) 		Case style C Case L: 0.300" (7.6 mm) Case \varnothing : 0.125" (3.2 mm) 		Short case style B Case L: .188" (4.8 mm) Case \varnothing : .188" (4.8 mm) Flange \varnothing : 0.250" (6.4 mm) 	
	Single	Dual	Single	Dual	Single	Dual	Single	Dual
E = Chromel-Constantan	TC102620E	TC102620EE	TC102621E	TC102621EE	TC102622E	TC102622EE	TC102663E	TC102663EE
J = Iron-Constantan	TC102620J	TC102620JJ	TC102621J	TC102621JJ	TC102622J	TC102622JJ	TC102663J	TC102663JJ
K = Chromel-Alumel	TC102620K	TC102620KK	TC102621K	TC102621KK	TC102622K	TC102622KK	TC102663K	TC102663KK
T = Copper-Constantan	TC102620T	TC102620TT	TC102621T	TC102621TT	TC102622T	TC102622TT	TC102663T	TC102663TT

STOP OIL SEEPAGE!

Feedthroughs provide an oil tight seal where a cable exits a machine housing. The stainless steel tube is epoxy filled and each wire is sealed to the individual conductor. This prevents wicking of oil inside the wires as well as leakage around the wire insulation. Pressure rating to 25 psi (1.7 bar.) See page 3-11 for details.

Leadwire and cable seal models FG1015, FG3015 and FG4015 seal RTD or thermocouple leadwires where they exit oil-filled bearing housings of rotating equipment. Both versions include a grommet that provides the seal and allows adjustment of the wire or cable position. See page 3-12 for details.

Elastomer rubber-filled cable has elastomer fill between the wires, stainless steel braid, and outer jacket. This fill can extend along the entire length of the cable, or a specified portion. The outside of the cable can be sealed with an FG1015, FG3015 and FG4015 fitting. See Leadwire Covering Options on Miniature Sensors on pages 6-2 to 6-10.

Minco Application Aid #27 provides more information on the problems of oil seepage and various solutions. Download AA#27 at www.minco.com



▼ = STANDARD OPTIONS
Specifications subject to change

Non-sparking Embedment Sensors

ATEX  **II 3 G Ex nA IIC Gc**
IECEx Ex nA IIC Gc

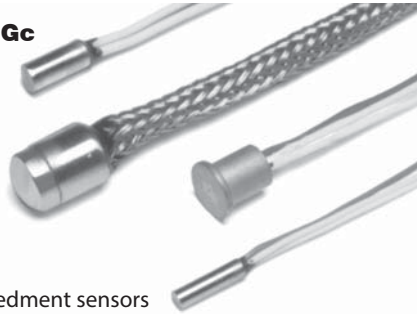

Overview

- Non-sparking embedment sensors for monitoring the temperature of thrust bearings
- Four case styles offer a variety of installation options
- Certified for use in Zone 2, Group IIC hazardous areas, defined by EN/IEC 60079-0 and EN/IEC 60079-15

Specifications

Temperature range: -50 to 200°C (-58 to 392°F), reducing to 125°C (257°F) when elastomer filled cable is ordered.

Case: Tin plated copper alloy.

Babbitt tip: Factory applied babbitt tip, available on case style A, B, and short style B, reduces the danger of overheating the sensor when installed in babbitt layer.

Leads:

RTD: stranded copper with PTFE insulation.

Stainless steel braid, FEP over PTFE and FEP over stainless steel braid with elastomer fill are optional.

Thermocouple: stranded, PTFE insulated, twisted pairs.

Stainless steel braid, FEP over PTFE and FEP over stainless steel braid with elastomer fill are optional.

Leadwire size (AWG):

RTD					
Case style	Number of leads				
	2	3	4	6	8
A	24	24	24	24	
B	24	24	28	28	28
C	24	26	30	30	
Short B	24	24	28	28	
Thermocouple					
All cases	24		24		

Time constant: 3.0 seconds (case style A), typical in moving water.

Insulation resistance: 10 megohms minimum at 100 VDC, leads to case.

▼ = **STANDARD OPTIONS**
 Specifications subject to change

Specification and order options:

RTD

S207596PD	Model number from next page
3	Number of leads per sensing element (2, 3 or 4): CA or PD elements not available with 2 leads 4 leads available on all single elements and dual S207596 + S207598 only
E	Covering over leadwires: T = PTFE insulated leads only S = Stainless steel overbraid with PTFE insulated leads F = FEP over PTFE insulated leads E = FEP over stainless steel braid, with elastomer fill and PTFE insulated leads (max. fill length 240")
40	Lead length in inches ▼:40, 120
(Stop here for case style C; no installation variable)	
AC1	Optional Installation/Accessory option B0 = No babbitt metal or accessories B1 = Babbitt metal applied AC1 = Supplied with AC171 spring and AC172 series ring (case style B only) AC2 = Supplied with AC171 spring and AC1038 ring (case style B only) AC3 = Supplied with AC171 spring and AC915-1 ring (case style B only)
S207596PD3E40AC1 = Sample part number	

Thermocouple

TC207600K	Model number from next page
U	Junction grounding: G = Grounded U = Ungrounded
40	Lead length in inches ▼:40, 120
S	Covering over leadwires: T = PTFE insulated leads only S = Stainless steel overbraid with PTFE insulated leads F = FEP over PTFE insulated leads E = FEP over stainless steel braid, with elastomer fill and PTFE insulated leads (max fill length 240")
(Stop here for case style C; no installation variable)	
B0	Optional Installation/Accessory option B0 = No babbitt metal or accessories B1 = Babbitt metal applied AC1 = Supplied with AC171 spring and AC172 series ring (case style B only) AC2 = Supplied with AC171 spring and AC1038 ring (case style B only) AC3 = Supplied with AC171 spring and AC915-1 ring (case style B only)
TC207600KU40SB0 = Sample part number	

RTD Element	TCR $\Omega/\Omega/^{\circ}\text{C}$	Case style A Case L: 0.250" (6.4 mm) Case Ø: 0.275" (7.0 mm)		Case style B Case L: 0.250" (6.4 mm) Case Ø: 0.188" (4.8 mm) Flange Ø: 0.250" (6.4 mm)		Case style C Case L: 0.300" (7.6 mm) Case Ø: 0.125" (3.2 mm)		Short case style B Case L: .188" (4.8 mm) Case Ø: .188" (4.8 mm) Flange Ø: 0.250" (6.4 mm)	
		Single	Dual	Single	Dual	Single	Dual	Single	Dual
Platinum, 100 Ω $\pm 0.36\%$ at 0°C	.00392	S207595PA	S207595PAPA	S207596PA	S207596PAPA	S207597PA	S207597PAPA	S207598PA	S207598PAPA
Platinum, 100 Ω $\pm 0.12\%$ at 0°C (Meets EN60751, Class B)	.00385	S207595PD	S207595PDPD	S207596PD	S207596PDPD	S207597PD	S207597PDPD	S207598PD	S207598PDPD
Platinum, 100 Ω $\pm 0.067\%$ at 0°C (Meets EN60751, Class A)	.00385	S207595PM	S207595PMPM	S207596PM	S207596PMPM	S207597PM	S207597PMPM	S207598PM	S207598PMPM
Platinum, 100 Ω $\pm 0.36\%$ at 0°C	.00385	S207595PE	S207595PEPE	S207596PE	S207596PEPE	S207597PE	S207597PEPE	S207598PE	S207598PEPE
Platinum, 1000 Ω $\pm 0.12\%$ at 0°C	.00385	S207595PF	S207595PFPF	S207596PF	S207596PFPF	S207597PF	S207597PFPF	S207598PF	S207598PFPF
Copper, 10 Ω $\pm 0.2\%$ at 25°C	.00427	S207595CA	S207595CACA	S207596CA		S207597CA		S207598CA	
Nickel, 120 Ω $\pm 0.5\%$ at 0°C	.00672	S207595NA	S207595NANA	S207596NA	S207596NANA	S207597NA		S207598NA	S207598NANA

Thermocouple Junction Type	Case style A Case L: 0.250" (6.4 mm) Case Ø: 0.275" (7.0 mm)		Case style B Case L: 0.250" (6.4 mm) Case Ø: 0.188" (4.8 mm) Flange Ø: 0.250" (6.4 mm)		Case style C Case L: 0.300" (7.6 mm) Case Ø: 0.125" (3.2 mm)		Short case style B Case L: .188" (4.8 mm) Case Ø: .188" (4.8 mm) Flange Ø: 0.250" (6.4 mm)	
	Single	Dual	Single	Dual	Single	Dual	Single	Dual
E = Chromel-Constantan	TC207600E	TC207600EE	TC207601E	TC207601EE	TC207602E	TC207602EE	TC207603E	TC207603EE
J = Iron-Constantan	TC207600J	TC207600JJ	TC207601J	TC207601JJ	TC207602J	TC207602JJ	TC207603J	TC207603JJ
K = Chromel-Alumel	TC207600K	TC207600KK	TC207601K	TC207601KK	TC207602K	TC207602KK	TC207603K	TC207603KK
T = Copper-Constantan	TC207600T	TC207600TT	TC207601T	TC207601TT	TC207602T	TC207602TT	TC207603T	TC207603TT

STOP OIL SEEPAGE!

Feedthroughs provide an oil tight seal where a cable exits a machine housing. The stainless steel tube is epoxy filled and each wire is sealed to the individual conductor. This prevents wicking of oil inside the wires as well as leakage around the wire insulation. Pressure rating to 25 psi (1.7 bar.) See page 3-11 for details.

Leadwire and cable seal models FG1015, FG3015 and FG4015 seal RTD or thermocouple leadwires where they exit oil-filled bearing housings of rotating equipment. Both versions include a grommet that provides the seal and allows adjustment of the wire or cable position. See page 3-12 for details.





Elastomer rubber-filled cable has elastomer fill between the wires, stainless steel braid, and outer jacket. This fill can extend along the entire length of the cable, or a specified portion. The outside of the cable can be sealed with an FG1015, FG3015 and FG4015 fitting. See Leadwire Covering Options on Miniature Sensors on pages 6-2 to 6-10.



Minco Application Aid #27 provides more information on the problems of oil seepage and various solutions. Download AA#27 at www.minco.com

▼ = STANDARD OPTIONS
Specifications subject to change

Bolt-on Temperature Sensors

	Dimensions W x L x T (max.)	Temp. range	Element options	Case material	Leadwire	Model
	0.50 x 1.00 x 0.188" (12.7 x 25.4 x 4.8 mm) w/ 0.161" (4.1 mm) diameter hole	-70 to 500°C (-94 to 932°F)	PD, PF	Stainless steel	AWG 22, Mica-glass insulated	▼ S101730
	0.29 x 1.25 x 0.188" (7.4 x 31.8 x 4.8 mm) with 0.161" (4.1 mm) hole	-70 to 500°C (-94 to 932°F)	PD, PF	Stainless steel	AWG 22, Mica-glass insulated	▼ S101731
	0.265" (6.7 mm) ID ring lug	-50 to 260°C (-58 to 500°F)	PD, PF	Nickel plated copper	2 lead: AWG 24, 3 lead: AWG 26, PTFE insulated	▼ S101732
	0.50 x 0.375 x 0.188" (12.7 x 9.5 x 4.8 mm) with 0.166" (4.2 mm) hole	-50 to 260°C (-58 to 500°F)	PD, PF	Stainless steel	2 lead: AWG 24, 3 lead: AWG 26, PTFE insulated with SS braid cover	▼ S101733
	1/4" - 20 x 3/8" long thread with 7/16" hex head	-50 to 260°C (-58 to 500°F)	PD, PF	Stainless steel	2 lead: AWG 24, 3 lead: AWG 26, PTFE insulated with SS braid cover	▼ S101734
	M6 x 1 thread, 10 mm long, with 10 mm hex					▼ S101797

Overview

Bolt-on temperature sensors are designed for easy installation in industrial and commercial environments. The sensors can be mounted on machines, against process pipes, or embedded directly into a machined part. Threaded fasteners install in seconds and can be easily removed for installation at another location.

These sensors are ideal for process control measurements, test and verification of existing systems, and retrofitting existing machines. Standard designs allow prototyping without high setup costs, while significant discounts are available for large quantities.

Standard platinum and nickel RTD elements provide stable and reliable output compatible with most control and monitoring systems. Physically interchangeable designs allow you to easily customize your installation to different instrumentation. Minco can also provide custom RTD, thermistor or thermocouple elements in these packages, or specialized case designs to meet your application needs.

- Removable and reusable
- Wide temperature range
- Configurations to fit most applications
- Standard 100 Ω platinum, 1000 Ω platinum and 100 Ω nickel elements

Specification and order options:

S101732	Model number from table
PD	Element code from table
3	Number of leads: ▼: 2 or 3 2 leads not recommended for PD models
S	Leadwire covering: ▼ G = Mica-glass (S101730 and S101731) ▼ T = PTFE (S100722, S101732, S101733, S101734, and S101797) ▼ S = Stainless steel braid over PTFE insulated leads (S100722, S101732, S101733, S101734, and S101797)
40	Leadwire length (inches): 40" (1000 mm) standard ▼: 40, 120
S101732PD3S40 = Sample part number	

Specifications

Time constant: Less than 10 seconds in moving water.

Insulation resistance: 10 megohms minimum at 100 VDC, leads to case.

Vibration: Withstands 10 to 2000 Hz at 20 G's minimum per MIL-STD-202. Method 204, test condition D.

Element specifications*		Code
Platinum (0.00385 TCR) (EN60751, Class B)	100 Ω ±0.12% at 0°C	▼ PD
Platinum (0.00385 TCR)	1000 Ω ±0.12% at 0°C	▼ PF
Nickel 0.00618 TCR)	100 Ω ±0.22% at 0°C	NB









*See descriptions for element options on each model.



STOCKED PARTS AVAILABLE

▼ = **STANDARD OPTIONS**
Specifications subject to change

Economy Sensors

	Dimensions	Temperature range	Element options	Case material	Leadwire	Model
	2 leads: .050" x .065" x .035" thick (1.3 x 1.7 x .9 mm) Thin-Film with insulated leads 3 leads: .063" x .098" x .035" thick (1.6 x 2.5 x .9 mm) Thin-Film with insulated leads	-50 to 150°C (-58 to 302°F)	PD, PF	Ceramic	AWG 32 solid enamel insulated	▼ S102404
	Ø .125" x .90" (Ø 3.2 x 22.9 mm)	-50 to 260°C (-58 to 500°F)	PD, PF	Stainless steel	AWG 26, PTFE insulated	▼ S102409
	Ø .125" x .90" (Ø 3.2 x 22.9 mm)	-50 to 155°C (-58 to 311°F)	PD, PF	Stainless steel	AWG 30, PTFE insulated	▼ S102737
	Ø .140" x .40" (Ø 3.6 x 10.2 mm)	-70 to 500°C (-94 to 932°F)	PD, PF	Ceramic	AWG 27, solid glass insulated nickel	▼ S102410
	Ø .188" x .90" (Ø 4.8 x 22.9 mm)	-50 to 150°C (-58 to 302°F)	PD, PF	Silicone rubber	AWG 24, silicone rubber insulated	▼ S102406
	Ø .188" x 1.25" (Ø 4.8 x 31.8 mm)	-50 to 230°C (-58 to 446°F)	PD, PF	PTFE	AWG 24, PTFE with PTFE jacket	▼ S102405
	Ø .188" x 1.25" (Ø 4.8 x 31.8 mm)	-50 to 260°C (-58 to 500°F)	PD, PF	Aluminum	AWG 22, PTFE insulated	▼ S102407
	Ø .188" x 2.38" (Ø 4.8 x 60.5 mm)	-70 to 550°C (-94 to 1022°F)	PD, PF	Stainless steel	AWG 22, glass braid insulated	▼ S102408

MINIATURE SENSORS

Overview

Economy sensors are designed to be a component of your final assembly. With insulated leads preattached and strain relieved, final construction is easy and reliable.

- Insulated leads of variable length, installed and strain relieved
- Wide temperature range
- Configurations to fit most applications
- Standard 100 Ω platinum, 1000 Ω platinum and 120 Ω nickel elements

Specifications

Insulation resistance: 10 megohms minimum at 100 VDC, leads to case.

Vibration: Withstands 10 to 2000 Hz at 20 G's minimum per MIL-STD-202. Method 204, test condition D.

Element specifications*	Code
Platinum (0.00385 TCR) 100 Ω ±0.12% at 0°C (EN60751, Class B)	▼ PD
Platinum (0.00385 TCR) 1000 Ω ±0.12% at 0°C	▼ PF

* See descriptions for element options on each model.

Specification and order options

S102408	Model number from table
PD	Element code from table
3	Number of leads: ▼ 2 leads (not recommended for PD models) or ▼ 3 leads (only option for S102410PD)
G	Leadwire covering: ▼ E = Enamel (S102404) ▼ G = Glass (S102408 and S102410) ▼ R = Silicone rubber (S102406) ▼ T = PTFE (S102405, S102407, S102409, S102737)
40	Leadwire length in inches: 40" (1000 mm) standard ▼ : 40, 120
S102408PD3G40 = Sample part number	



STOCKED PARTS AVAILABLE

▼ = STANDARD OPTIONS
Specifications subject to change



Installation and Accessories

Case style A

Install case style A sensor just below the babbitt layer, then puddle the babbitt metal over the sensor tip and smooth. Read [Engineering Instruction #164](#) and [Engineering Instruction #167](#) for complete details.

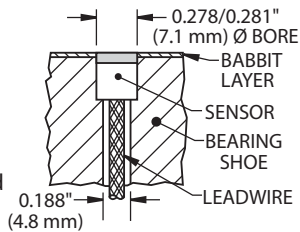

Case style B

The “top hat” flange shape allows spring loading with the AC171 spring and AC172 or AC915 retaining ring (order separately). Choose the economical AC172 style for lowest cost. The AC915 style allows removal and reinstallation. Slide the spring and ring over the leads, insert the sensor tip into a milled hole, and push down on the retaining ring to compress the spring and secure the sensor. Read [Engineering Instruction #180](#) and [Engineering Instruction #181](#).

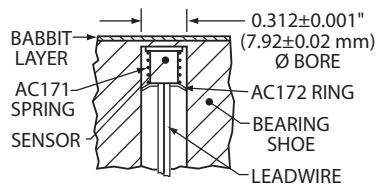

Case styles C and D

Pot with epoxy inside small bearing shoes. Locate near the babbitt face for best readings. Read [Engineering Instruction #184](#).

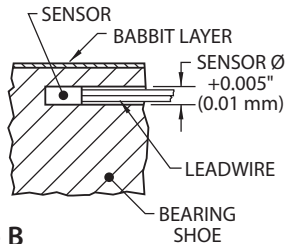

AC171 spring for case style B

Stainless steel. Outside diameter 0.240" (6.1 mm). Compressed length 0.22" (5.6 mm). To be used in conjunction with AC172 or AC915 for spring loading case style B

Feedthroughs

Feedthroughs provide an oil tight seal where a cable exits a machine housing. The stainless steel tube is epoxy filled and each wire is sealed to the individual conductor. This prevents wicking of oil inside the wires as well as leakage around the wire insulation. Pressure rating to 25 psi (1.7 bar). See page 3-12 for more information.

AC172 and AC915 retaining ring for case style B

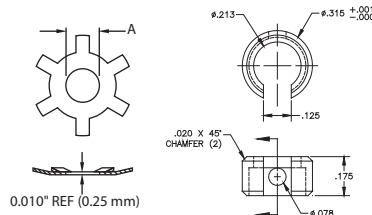

Model	"A" diameter	Hole I.D.
AC172	sized to fit leadwires	0.312" (7.92 mm)
AC172-3	0.175" (4.45 mm)	0.375" (9.53 mm)
AC915-1	0.213" (5.4 mm)	0.312" (7.92 mm)

AC190 terminal block

Two tin-plated brass terminals. PTFE body. Meets MIL-T-17600. For instructions, read [Installation Instruction #107](#).

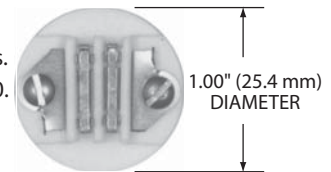

AC191 terminal block

Two tin-plated brass terminals. PTFE body. Meets MIL-T-17600. Read [Installation Instruction #121](#) for instructions.



AC192 terminal block

Three tin-plated brass terminals. Glass-filled PTFE body.

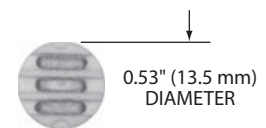

AC195 terminal block

Same as AC192 except polyamide-imide body for radiation resistance to 10⁹ rads.

AC197 terminal block

Three tin-plated brass terminals. Glass-filled PTFE body.



AC196 terminal block

Same as AC197 except polyamide-imide body for radiation resistance to 10⁹ rads.

▼ = **STANDARD OPTIONS**
Specifications subject to change