

FITOK

Valves and Fittings

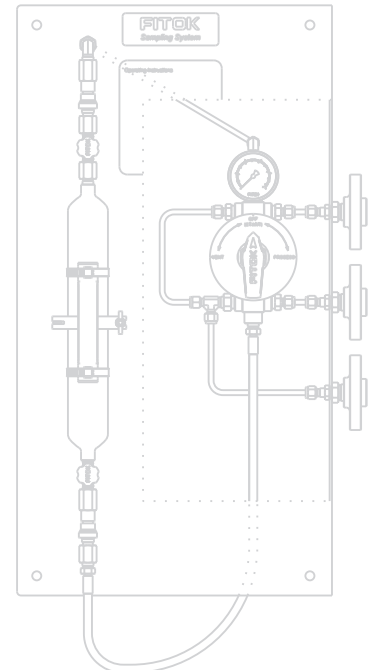

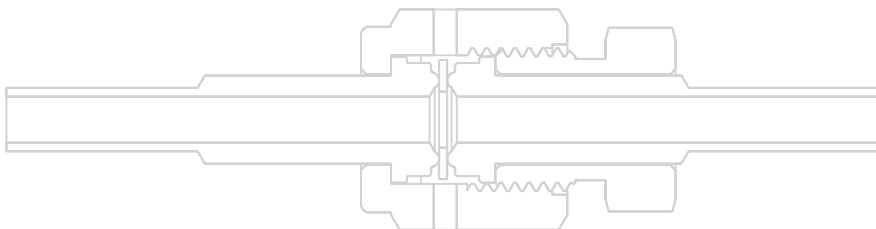
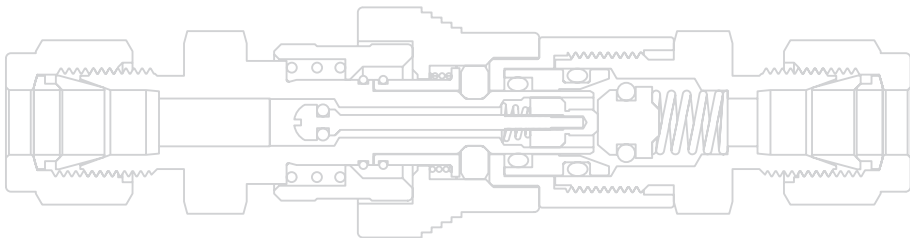

Germany (Headquarter)
R&D Center, Factory



The USA
Global Sales and Service Center



China
Factory and Shared Service Center



The UAE
Regional Sales and Service Center

Founded in 1998, FITOK Group has been an industry-leading developer and manufacturer of superior quality instrumentation valves and fittings, having our R&D centers, manufacturing facilities, warehousing and service locations in Offenbach Germany, Texas USA, Shenzhen China and Dubai UAE.

We have the capability to manufacture and supply 4 different product categories, including:

- General Instrumentation Valves and Fittings;
- Medium & High Pressure Valves and Fittings;
- High Purity & Ultra High Purity Valves and Fittings; and
- Sampling Systems.

Our mission is to provide the best quality products and the most professional services to our customers. The performance of our products is guaranteed during the whole manufacturing cycle from our employment of customized materials which should be controlled more strictly than just according to ASTM requirements to our implementation of production and testing exceeding the industry standards.

Since our inception, FITOK has been applying sound quality control standards in all activities. FITOK is an ISO 9001:2015 certified company and our products have been certified by different industry authorities and third-party inspection institutions in different countries to have obtained a variety of certificates, among which there are the TA-Luft, ABS, ASTM F1387, TPED, E-Mark, CRN, DVGW, PED, API and DOT certificates.

Benefiting from our global facilities, we are able to optimize the most cost-effective resources worldwide. Paired with flexible manufacturing systems, we deliver a wide range of the best quality products within a competitive lead time and the most professional services to our customers in an array of applications and industries.

Manufacturing Facilities



Private Forging Plant



Thread Rolling Machine



Class 100 Cleanroom

CERTIFICATES



FITOK Germany ISO 9001



FITOK China ISO 9001



ABS



ASTM F1387



TA-Luft



DVGW



CRN



EAC



API 607



ATEX



TPED



DOT

6 Series Tube Fittings



6 Series Weld Fittings



37° Flared Tube Fittings



VL Series Vacuum Tube Fittings



6 Series Pipe Fittings



VA Series Vacuum Adapter Fittings



Fusible, Grease and Bleed Fittings



Calibration Fittings and Hoses



Quick-connects

©QC Series



©QV Series



©QF Series



©QM Series



©QTM Series



Hoses and Connectors

©MH and MM Series



©TH Series



©PS Series



©HC Series



©MP Series



Ball Valves

© BF and BFH Series



© BO Series



© BG Series



© BP Series



© BH Series



© BR Series

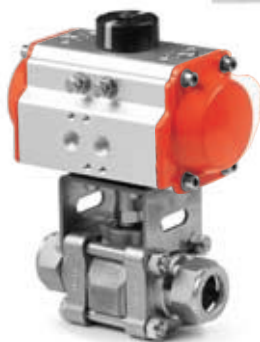

© BV Series



Needle Valves

©NB and NBH Series



©ND and NDH Series



©NF and NFH Series



©NG and NGH Series



©NT Series



©NR and NRG Series



©NY and NYH Series



©NU and NUH Series



Check Valves

© CV Series



© CH Series



© CO Series



© CA Series



© CW Series



© COA Series



© CL Series



Bellows-sealed Valves

© SW and SU Series



Metering Valves

© MS, MV, ML and MH Series



Plug Valves

© PV Series



Proportional Relief Valves

© RV, RL and RM Series



Purge Valves

©RP Series



Bleed Valves

©RB Series



Excess Flow Valves

©EV Series



Filters

©FT Series



©FB Series



©FI Series



©FW Series



Gauge Valves and Instrumentation Manifolds

Gauge Valves

©GV, GVH and GR Series



2-valve Manifolds

©2D, 2R, 2DH and 2RH Series



3-valve Manifolds

©3D, 3R, 3DH and 3RH Series



5-valve Manifolds

©5D, 5R, 5DH and 5RH Series



Block and Bleed Valves

©BB, DB, SB and DBB Series

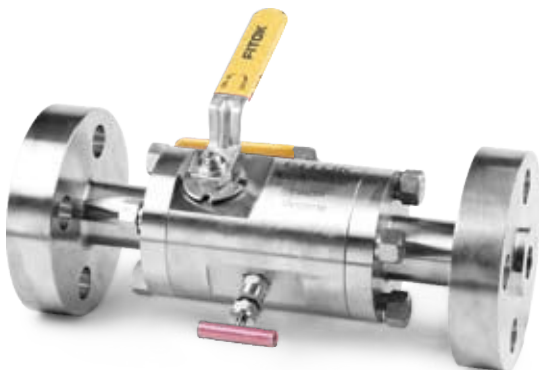
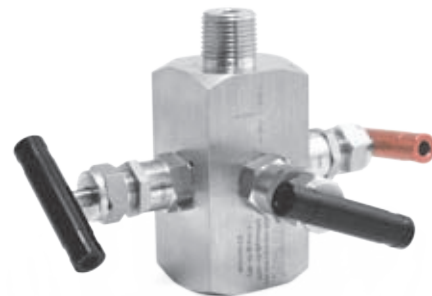

Two-piece Forged Metal-seated Ball Valves

©BM Series



Air Headers and Distribution Manifolds

©AH, AP, MN, MP and CM Series

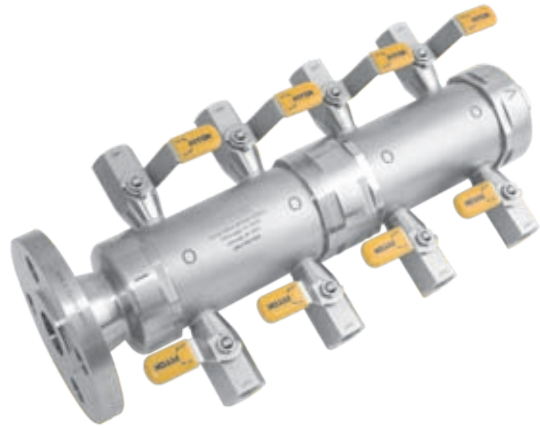

Two-piece Fire Safe Ball Valves

©BI Series



Condensate Pots and Vessels

©CP Series

©SV Series



Sample Cylinders



Pressure Gauges

©GA, GB and GC Series



Stainless Steel Seamless Tubing



Tools and Accessories

Hand Tube Benders
© HTB Series



Tube Cutters
© FTC Series



Other Elements

© Thermowells and Bosses



Manual Presetting Tools
© MPT Series



Hydraulic Presetting Tools
© HPT Series



© Syphons



Tube Deburring Tools
© TDT Series



Bulkhead Retainers
© BR Series



© Flush Rings



Gap Inspection Gauges
© GIG Series



Individual Sizes



Multiple Sizes

© Gaskets and O-rings



DHL Series Tube Fittings
10,000 - 15,000 psig



Pipe Fittings
10,000 - 60,000 psig



Medium Pressure Tube Fittings
20,000 psig



Adapters and Couplings
10,000 - 60,000 psig



High Pressure Tube Fittings
60,000 psig



Quick Couplings
10,000 - 30,000 psig

© HQP, HQB, HQS and HQC Series



Ball Valves
10,000 - 20,000 psig
© 10B, 15B and 20B Series



Pneumatic Ball Valves
10,000 - 20,000 psig
© AO, AC and AOC Types



Needle Valves

10,000 - 60,000 psig

© 10N, 15N, 20N, 30N and 60N Series



Pneumatic Needle Valves

10,000 - 60,000 psig

© ATO and ATC Types



Check Valves

10,000 - 60,000 psig

© 10C, 15C, 20C and 60C Series

© 10CO, 15CO, 20CO and 60CO Series



Metering Valves

15,000 - 60,000 psig

© 15M, 30M and 60M Series



Relief Valves

20,000 - 60,000 psig

© HSR, HMR and HAR Series



Bleed Valves and Block & Bleed Valves

15,000 - 30,000 psig

© 15BV, 20BV and 30BV Series

© 15BN, 20BN, 20DBN and 15DBB Series



Line Filters

10,000 - 60,000 psig

- © 10FD, 15FD, 20FD and 60FD Series
- © 10FC, 15FC, 20FC and 60FC Series



Subsea Valves

10,000 - 20,000 psig

- © Subsea Ball Valves, Subsea Check Valves, Subsea Needle Valves and Subsea Hydraulic Directional Control Valves



Tubing

10,000 - 60,000 psig



Tools

© Coning Tools



© Threading Tools



© Reseating Tools



© Manual Presetting Tools



© Hydraulic Presetting Tools



Weld Fittings

◎ M Series Micro Weld Fittings



◎ L Series Tube Butt Weld Fittings



◎ A Series Automatic Tube Butt Weld Fittings



◎ T Series Tubular Fittings



Cylinder Connections

◎ CGA DISS, CGA and DIN Series



Face Seal Fittings

◎ FR Series Metal Gasket Face Seal Fittings



◎ FO Series O-ring Face Seal Fittings



◎ TFO Series L-ring Face Seal Fittings



Diaphragm Valves

○ DQ, DP, DH, DM, DS, DR, DV, DL and DF Series



Bellows-sealed Valves

○ SM and SVH Series



Cylinder Pressure Regulators

○ FCR-1, FCR-1S, FCR-2 and FCR-1D Series



Check Valves

○ CW Series



Regulators

○ FHR-1 Series



Back Pressure Regulators

○ BPR-1, BPR-2 and BPR-3 Series



Line Pressure Regulators

○ FLR-1, FLR-2, FLR-3, FBR-1, HPR-10 and HPL-06 Series



Pressure Control Panels

○ FSR-1 and FSR-2 Series



Changeover Systems

○ FDR-1, FDR-2, FDR-1L and FDR-1T Series



Point-of-use Panels

○ FPR-1 and FPR-1S Series



Bottle Configuration Sampling Systems

©BLA2 - System Purge Type



©BLD2 - Continuous Needle Purge Type



©BLE3 - Back Purge Type with Venturi Unit



Cylinder Configuration Sampling Systems

©CSF4 - Outlet to Flare Type with Expansion Chamber



©CGG1 - System Purge Type



Seamless Straight-length Tubing

Instrumentation Tubing



High-purity Tubing



Medium and High Pressure Tubing

○ DHL Series Tubing



○ Medium Pressure Tubing



○ High Pressure Tubing



Seamless Coiled Tubing



PVC Jacketed Tubing



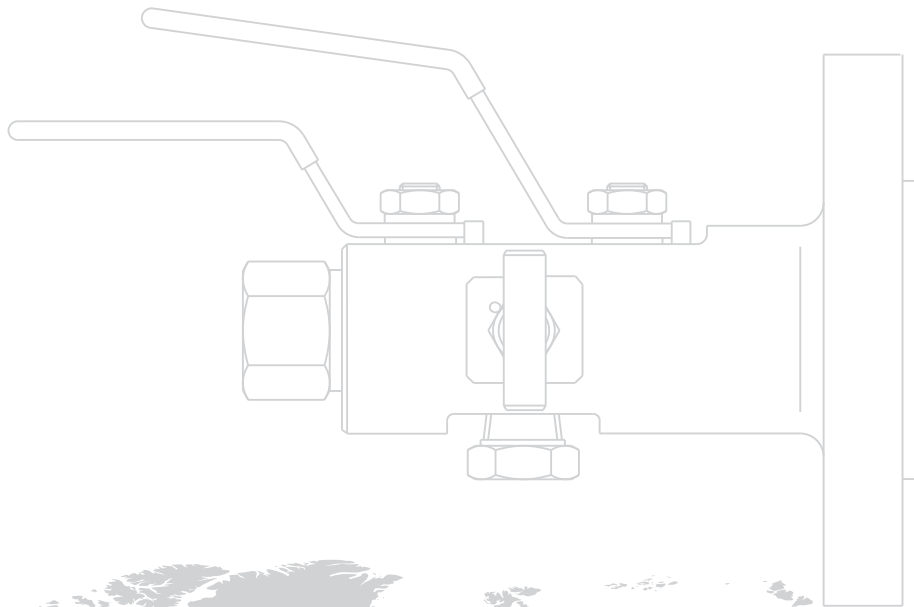

FITOK Group

FITOK GmbH (Headquarter)

Sprendlinger Landstr. 115, 63069 Offenbach am Main, Germany
 Tel.: +49 69 8900 4498 Fax: +49 69 8900 4495

FITOK, Inc.

13843 North Promenade Blvd., Suite 750, Stafford, Texas 77477, USA
 Tel.: +1 281 888 0077 Fax: +1 281 582 4051

FITOK Incorporated

1-4F, Block C, Zone E, Yingtai Industrial Park, Dalang Street,
 Longhua District, Shenzhen, 518109, China
 Tel.: +86 755 2803 2500 Fax: +86 755 2803 2619

FITOK Middle East Oil Equipment Trading LLC

208-209, Makateb Building, P.O.Box 185412, Airport Road, Deira, Dubai, UAE
 Tel.: +971 4 2959 853 Fax: +971 4 2959 854

info@fitokgroup.com
 www.fitokgroup.com

