

Weld Fittings

M Series



L Series



A Series



T Series



Weld Fittings

Features

- ⊙ Radius junction design with elbows to provide smooth flow path
- ⊙ Precision machined diameter to match tube diameter
- ⊙ Square, burr-free tube weld ends to enhance alignment
- ⊙ Manual or automatic welding equipment both applicable
- ⊙ Tube wall uniformity to promote weld repeatability
- ⊙ Standard surface roughness finished to an average of Ra 10 µin. (0.25 µm) or electropolished to Ra 5 µin. (0.13 µm) optional
- ⊙ Each fitting marked with size, material and heat number

Technical Data

- ⊙ Materials:

Material	Bar Stock ^①	Forging ^②	Designator
316 SS	ASTM A479/A276	ASTM A182/A314	SS
316L SS			6L
316L VAR SS	ASTM A479/A276 SEMI F20	—	6LV
316L VIM-VAR SS			6LW

① Only for straight configurations and all M Series weld fittings.

② Includes all elbows, crosses and tees, excluding M Series weld fittings.

- ⊙ Working Pressure:
 - a. Working pressures shown in the Catalog are calculated according to ASME B31.3 and B31.1 at ambient temperature.
 - b. To get the allowable working pressure at elevated temperature, use the allowable working pressure at ambient temperature to multiply the elevated temperature factors. Please refer to Table 22 - Elevated Temperature Factors in the FITOK Catalog **Tubing** for the elevated temperature factors.

- ⊙ Working Temperature:

Material	Minimum Temperature	Maximum Temperature
316 SS	-325°F (-198°C)	1000°F (538°C)
316L SS	-325°F (-198°C)	850°F (454°C)
316L VAR SS		
316L VIM-VAR SS		

Ordering Information

- ⊙ Add the material designator as a prefix, cleaning and packaging code as a suffix to the basic ordering number to get the complete ordering number.
- ⊙ Cleaning and Packaging
 - a. FC-01 Standard Cleaning and Packaging is applied for general industrial procedures. No suffix is needed.
 - b. FC-02 Special Cleaning and Packaging, to ensure compliance with product cleanliness requirement as stated in ASTM G93 Level C. Add "-F2" as a suffix when needed.
 - c. FC-03 Ultra-High Purity Process Specification is applied to products with wetted surface roughness finished to an average of Ra 5 µin. (0.13 µm). Add "-F3" as suffix when needed.

Example: For 1/2" 316L VAR SS Union Tee with FC-03 Ultra-High Purity Process Specification, the ordering number is 6LV-WT1-TB8-F3.

Cautions

- ⊙ Dimensions are for reference only and are subject to change.
- ⊙ Welding of the same material is more advisable considering the same coefficient of expansion, lower possibility of poor weld, out-of-roundness or dimensional changes.
- ⊙ Tungsten Inert Gas Welding (TIG) is recommended.

M Series Micro Weld Fittings

Features

- Compact design
- Sizes range from 1/8" to 1/2" and 6 mm to 12 mm
- Applicable to miniaturized tubing system



Reducing Unions

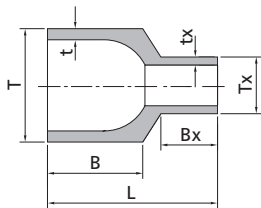

T-Tube O.D. (in.)	t-Wall Thickness (in.)	Tx-Tube O.D. (in.)	tx-Wall Thickness (in.)	Basic Ordering Number	Dimensions, in. (mm)			Working Pressure psig (bar)
					L	B	Bx	
1/4	0.035	1/8	0.028	-WU1-TB4-TB2	0.75 (19.1)	0.42 (10.7)	0.25 (6.4)	5100 (351)
3/8	0.035	1/4	0.035	-WU1-TB6-TB4	0.75 (19.1)	0.42 (10.7)	0.25 (6.4)	3300 (227)
1/2	0.049	1/4	0.035	-WU1-TB8-TB4	0.75 (19.1)	0.42 (10.7)	0.25 (6.4)	3700 (254)
1/2	0.049	3/8	0.035	-WU1-TB8-TB6	0.75 (19.1)	0.42 (10.7)	0.25 (6.4)	3300 (227)

90° Union Elbows

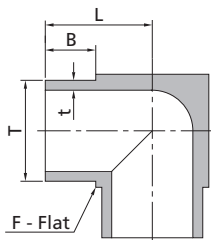

T-Tube O.D. (in.)	t-Wall Thickness (in.)	Basic Ordering Number	Dimensions, in. (mm)			Working Pressure psig (bar)
			L	B	F	
1/8	0.028	-WL1-TB2	0.41 (10.4)	0.25 (6.4)	5/16 (7.9)	8500 (585)
1/4	0.035	-WL1-TB4	0.41 (10.4)	0.25 (6.4)	5/16 (7.9)	5100 (351)
3/8	0.035	-WL1-TB6	0.47 (11.9)	0.25 (6.4)	7/16 (11.1)	3300 (227)
1/2	0.049	-WL1-TB8	0.53 (13.5)	0.25 (6.4)	9/16 (14.3)	3700 (254)

T-Tube O.D. (mm)	t-Wall Thickness (mm)	Basic Ordering Number	Dimensions, mm (in.)			Working Pressure bar (psig)
			L	B	F	
6	1.0	-WL1-MTB6	10.4 (0.41)	6.4 (0.25)	7.9 (5/16)	420 (6095)
8	1.0	-WL1-MTB8	11.9 (0.47)	6.4 (0.25)	11.1 (7/16)	310 (4499)
10	1.0	-WL1-MTB10	11.9 (0.47)	6.4 (0.25)	11.1 (7/16)	240 (3483)
12	1.0	-WL1-MTB12	13.5 (0.53)	6.4 (0.25)	14.3 (9/16)	200 (2902)

Extended Leg 90° Union Elbows

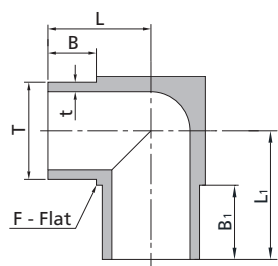

T-Tube O.D. (in.)	t-Wall Thickness (in.)	Basic Ordering Number	Dimensions, in. (mm)					Working Pressure psig (bar)
			B	B1	F	L	L1	
1/4	0.035	-WL1-TB4-1	0.25 (6.4)	0.45 (11.4)	5/16 (7.9)	0.41 (10.4)	0.61 (15.5)	5100 (351)
1/4	0.035	-WL1-TB4-2	0.25 (6.4)	0.50 (12.7)	5/16 (7.9)	0.41 (10.4)	0.66 (16.8)	5100 (351)
1/4	0.035	-WL1-TB4-3	0.45 (11.4)	0.45 (11.4)	5/16 (7.9)	0.61 (15.5)	0.61 (15.5)	5100 (351)
1/4	0.035	-WL1-TB4-4	0.50 (12.7)	0.50 (12.7)	5/16 (7.9)	0.66 (16.8)	0.66 (16.8)	5100 (351)

Reducing 90° Union Elbows

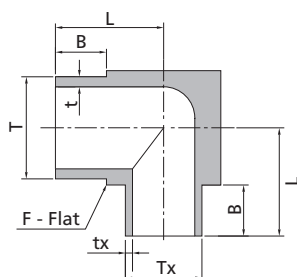

T-Tube O.D. (in.)	t-Wall Thickness (in.)	Tx-Tube O.D. (in.)	tx-Wall Thickness (in.)	Basic Ordering Number	Dimensions, in. (mm)			Working Pressure psig (bar)
					L	B	F	
3/8	0.035	1/4	0.035	-WL1-TB6-TB4	0.47 (11.9)	0.25 (6.4)	7/16 (11.1)	3300 (227)
1/2	0.049	1/4	0.035	-WL1-TB8-TB4	0.53 (13.5)	0.25 (6.4)	9/16 (14.3)	3700 (254)
1/2	0.049	3/8	0.035	-WL1-TB8-TB6	0.53 (13.5)	0.25 (6.4)	9/16 (14.3)	3300 (227)

T-Tube O.D. (mm)	t-Wall Thickness (mm)	Tx-Tube O.D. (mm)	tx-Wall Thickness (mm)	Basic Ordering Number	Dimensions, mm (in.)			Working Pressure bar (psig)
					L	B	F	
8	1.0	6	1.0	-WL1-MTB8-MTB6	11.9 (0.47)	6.4 (0.25)	11.1 (7/16)	310 (4499)
10	1.0	6	1.0	-WL1-MTB10-MTB6	11.9 (0.47)	6.4 (0.25)	11.1 (7/16)	240 (3483)
12	1.0	6	1.0	-WL1-MTB12-MTB6	13.5 (0.53)	6.4 (0.25)	14.3 (9/16)	200 (2902)
12	1.0	8	1.0	-WL1-MTB12-MTB8	13.5 (0.53)	6.4 (0.25)	14.3 (9/16)	200 (2902)

45° Union Elbows

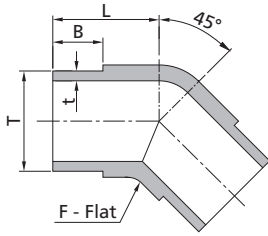

T-Tube O.D. (in.)	t-Wall Thickness (in.)	Basic Ordering Number	Dimensions, in. (mm)			Working Pressure psig (bar)
			L	B	F	
1/4	0.035	-WV1-TB4	0.41 (10.4)	0.25 (6.4)	5/16 (7.9)	5100 (351)
3/8	0.035	-WV1-TB6	0.47 (11.9)	0.25 (6.4)	7/16 (11.1)	3300 (227)
1/2	0.049	-WV1-TB8	0.53 (13.5)	0.25 (6.4)	9/16 (14.3)	3700 (254)

Tribows

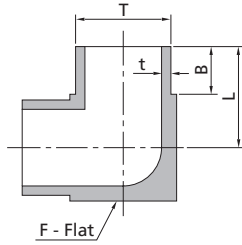

T-Tube O.D. (in.)	t-Wall Thickness (in.)	Basic Ordering Number	Dimensions, in. (mm)			Working Pressure psig (bar)
			L	B	F	
1/4	0.035	-WB1-TB4	0.41 (10.4)	0.25 (6.4)	5/16 (7.9)	5100 (351)
3/8	0.035	-WB1-TB6	0.47 (11.9)	0.25 (6.4)	7/16 (11.1)	3300 (227)
1/2	0.049	-WB1-TB8	0.53 (13.5)	0.25 (6.4)	9/16 (14.3)	3700 (254)



T-Tube O.D. (mm)	t-Wall Thickness (mm)	Basic Ordering Number	Dimensions, mm (in.)			Working Pressure bar (psig)
			L	B	F	
6	1.0	-WB1-MTB6	10.4 (0.41)	6.4 (0.25)	7.9 (5/16)	420 (6095)

Union Tees

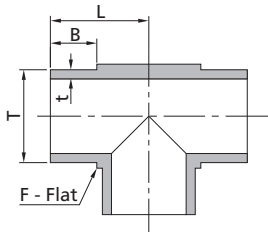

T-Tube O.D. (in.)	t-Wall Thickness (in.)	Basic Ordering Number	Dimensions, in. (mm)			Working pressure psig (bar)
			L	B	F	
1/8	0.028	-WT1-TB2	0.41 (10.4)	0.25 (6.4)	5/16 (7.9)	8500 (585)
1/4	0.035	-WT1-TB4	0.41 (10.4)	0.25 (6.4)	5/16 (7.9)	5100 (351)
3/8	0.035	-WT1-TB6	0.47 (11.9)	0.25 (6.4)	7/16 (11.1)	3300 (227)
1/2	0.049	-WT1-TB8	0.53 (13.5)	0.25 (6.4)	9/16 (14.3)	3700 (254)

T-Tube O.D. (mm)	t-Wall Thickness (mm)	Basic Ordering Number	Dimensions, mm (in.)			Working pressure bar (psig)
			L	B	F	
6	1.0	-WT1-MTB6	10.4 (0.41)	6.4 (0.25)	7.9 (5/16)	420 (6095)
8	1.0	-WT1-MTB8	11.9 (0.47)	6.4 (0.25)	11.1 (7/16)	310 (4499)
10	1.0	-WT1-MTB10	11.9 (0.47)	6.4 (0.25)	11.1 (7/16)	240 (3483)
12	1.0	-WT1-MTB12	13.5 (0.53)	6.4 (0.25)	14.3 (9/16)	200 (2902)

Extended Branch Leg Union Tees

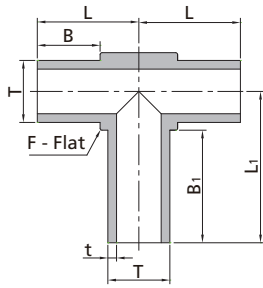

T-Tube O.D. (in.)	t-Wall Thickness (in.)	Basic Ordering Number	Dimensions, in. (mm)					Working Pressure psig (bar)
			L	L ₁	B	B ₁	F	
1/4	0.035	-WT1-TB4-45	0.41 (10.4)	0.61 (15.5)	0.25 (6.4)	0.45 (11.4)	5/16 (7.9)	5100 (351)

Extended Run Leg Union Tees

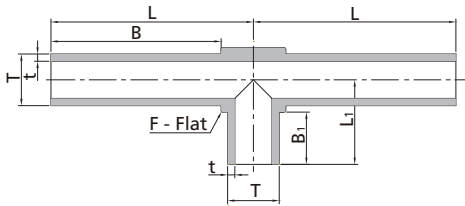

There may be a minor step between run ends at drill intersection.

T-Tube O.D. (in.)	t-Wall Thickness (in.)	Basic Ordering Number	Dimensions, in. (mm)					Working Pressure psig (bar)
			L	L ₁	B	B ₁	F	
1/4	0.035	-WT1-TB4-98	0.98 (24.9)	0.41 (10.4)	0.83 (21.1)	0.25 (6.4)	5/16 (7.9)	5100 (351)

Reducing Tees

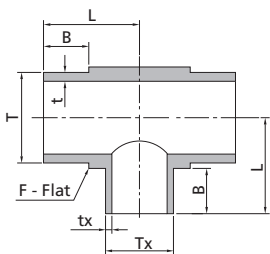

T-Tube O.D. (in.)	t-Wall Thickness (in.)	Tx-Tube O.D. (in.)	tx-Wall Thickness (in.)	Basic Ordering Number	Dimensions, in. (mm)			Working Pressure psig (bar)
					L	B	F	
3/8	0.035	1/4	0.035	-WT1-TB6-TB6-TB4	0.47 (11.9)	0.25 (6.4)	7/16 (11.1)	3300 (227)
1/2	0.049	1/4	0.035	-WT1-TB8-TB8-TB4	0.53 (13.5)	0.25 (6.4)	9/16 (14.3)	3700 (254)
1/2	0.049	3/8	0.035	-WT1-TB8-TB8-TB6	0.53 (13.5)	0.25 (6.4)	9/16 (14.3)	3300 (227)

F-07 Weld Fittings

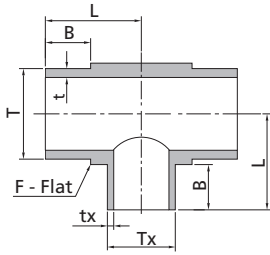

T-Tube O.D. (mm)	t-Wall Thickness (mm)	Tx-Tube O.D. (mm)	tx-Wall Thickness (mm)	Basic Ordering Number	Dimensions, mm (in.)			Working Pressure bar (psig)
					L	B	F	
10	1.0	6	1.0	-WT1-MTB10-MTB10-MTB6	11.9 (0.47)	6.4 (0.25)	11.1 (7/16)	240 (3483)
12	1.0	6	1.0	-WT1-MTB12-MTB12-MTB6	0.53 (13.5)	6.4 (0.25)	14.3 (9/16)	200 (2902)
12	1.0	8	1.0	-WT1-MTB12-MTB12-MTB8	0.53 (13.5)	6.4 (0.25)	14.3 (9/16)	200 (2902)

Union Crosses

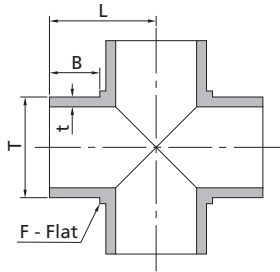

T-Tube O.D. (in.)	t-Wall Thickness (in.)	Basic Ordering Number	Dimensions, in. (mm)			Working Pressure psig (bar)
			L	B	F	
1/8	0.028	-WC1-TB2	0.41 (10.4)	0.25 (6.4)	5/16 (7.9)	8500 (585)
1/4	0.035	-WC1-TB4	0.41 (10.4)	0.25 (6.4)	5/16 (7.9)	5100 (351)
3/8	0.035	-WC1-TB6	0.47 (11.9)	0.25 (6.4)	7/16 (11.1)	3300 (227)
1/2	0.049	-WC1-TB8	0.53 (13.5)	0.25 (6.4)	9/16 (14.3)	3700 (254)

T-Tube O.D. (mm)	t-Wall Thickness (mm)	Basic Ordering Number	Dimensions, mm (in.)			Working Pressure bar (psig)
			L	B	F	
6	1.0	-WC1-MTB6	10.4 (0.41)	6.4 (0.25)	7.9 (5/16)	420 (6095)
8	1.0	-WC1-MTB8	11.9 (0.47)	6.4 (0.25)	11.1 (7/16)	310 (4499)
10	1.0	-WC1-MTB10	11.9 (0.47)	6.4 (0.25)	11.1 (7/16)	240 (3483)
12	1.0	-WC1-MTB12	13.5 (0.53)	6.4 (0.25)	14.3 (9/16)	200 (2902)

L Series Tube Butt Weld Fittings

Features

- Extended tube design
- Machined from forging blanks except for straight configurations
- Sizes range from 1/4" to 1" and 6 mm to 18 mm



Reducing Unions

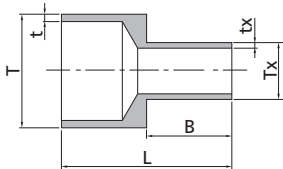

T-Tube O.D. (in.)	t-Wall Thickness (in.)	Tx-Tube O.D. (in.)	tx-Wall Thickness (in.)	Basic Ordering Number	Dimensions, in. (mm)		Working Pressure psig (bar)
					L	B	
3/8	0.035	1/4	0.035	-WU2-TB6-TB4	1.50 (38.1)	0.75 (19.1)	3300 (227)
1/2	0.049	1/4	0.035	-WU2-TB8-TB4	1.50 (38.1)	0.75 (19.1)	3700 (254)
1/2	0.049	3/8	0.035	-WU2-TB8-TB6	1.50 (38.1)	0.75 (19.1)	3300 (227)
3/4	0.049	1/2	0.049	-WU2-TB12-TB8	1.50 (38.1)	0.75 (19.1)	2400 (165)
1	0.065	1/2	0.049	-WU2-TB16-TB8	1.50 (38.1)	0.75 (19.1)	2400 (165)
1	0.065	3/4	0.049	-WU2-TB16-TB12	1.50 (38.1)	0.75 (19.1)	2400 (165)

T-Tube O.D. (mm)	t-Wall Thickness (mm)	Tx-Tube O.D. (mm)	tx-Wall Thickness (mm)	Basic Ordering Number	Dimensions, mm (in.)		Working Pressure bar (psig)
					L	B	
10	1.0	6	1.0	-WU2-MTB10-MTB6	38.1 (1.50)	19.1 (0.75)	240 (3483)
10	1.0	8	1.0	-WU2-MTB10-MTB8	38.1 (1.50)	19.1 (0.75)	240 (3483)
12	1.0	6	1.0	-WU2-MTB12-MTB6	38.1 (1.50)	19.1 (0.75)	200 (2902)
12	1.0	8	1.0	-WU2-MTB12-MTB8	38.1 (1.50)	19.1 (0.75)	200 (2902)
12	1.0	10	1.0	-WU2-MTB12-MTB10	38.1 (1.50)	19.1 (0.75)	200 (2902)
18	1.5	6	1.5	-WU2-MTB18-MTB6	38.1 (1.50)	19.1 (0.75)	200 (2902)
18	1.5	12	1.5	-WU2-MTB18-MTB12	38.1 (1.50)	19.1 (0.75)	200 (2902)

Union Elbows

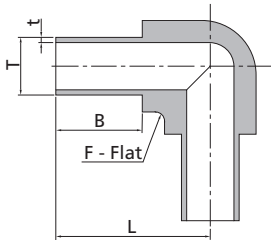

T-Tube O.D. (in.)	t-Wall Thickness (in.)	Basic Ordering Number	Dimensions, in. (mm)			Working Pressure psig (bar)
			L	B	F	
1/4	0.035	-WL2-TB4	1.23 (31.2)	0.75 (19.1)	7/16 (11.1)	5100 (351)
3/8	0.035	-WL2-TB6	1.20 (30.5)	0.75 (19.1)	7/16 (11.1)	3300 (227)
1/2	0.049	-WL2-TB8	1.34 (34.0)	0.75 (19.1)	11/16 (17.5)	3700 (254)
3/4	0.049	-WL2-TB12	1.46 (37.1)	0.75 (19.1)	15/16 (23.8)	2400 (165)

T-Tube O.D. (mm)	t-Wall Thickness (mm)	Basic Ordering Number	Dimensions, mm (in.)			Working Pressure bar (psig)
			L	B	F	
6	1.0	-WL2-MTB6	31.2 (1.23)	19.1 (0.75)	11.1 (7/16)	420 (6095)
8	1.0	-WL2-MTB8	31.2 (1.23)	19.1 (0.75)	11.1 (7/16)	310 (4499)
10	1.0	-WL2-MTB10	34.0 (1.34)	19.1 (0.75)	17.5 (11/16)	240 (3483)
12	1.0	-WL2-MTB12	34.0 (1.34)	19.1 (0.75)	17.5 (11/16)	200 (2902)
18	1.5	-WL2-MTB18	37.6 (1.48)	19.1 (0.75)	23.8 (15/16)	200 (2902)

Union Tees

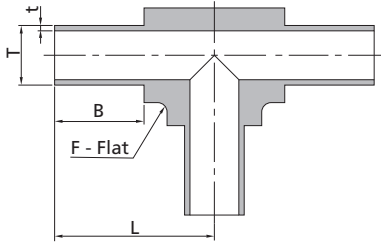

T-Tube O.D. (in.)	t-Wall Thickness (in.)	Basic Ordering Number	Dimensions, in. (mm)			Working Pressure psig (bar)
			L	B	F	
1/4	0.035	-WT2-TB4	1.23 (31.2)	0.75 (19.1)	7/16 (11.1)	5100 (351)
3/8	0.035	-WT2-TB6	1.20 (30.5)	0.75 (19.1)	7/16 (11.1)	3300 (227)
1/2	0.049	-WT2-TB8	1.34 (34.0)	0.75 (19.1)	11/16 (17.5)	3700 (254)
3/4	0.049	-WT2-TB12	1.46 (37.1)	0.75 (19.1)	15/16 (23.8)	2400 (165)

T-Tube O.D. (mm)	t-Wall Thickness (mm)	Basic Ordering Number	Dimensions, mm (in.)			Working Pressure bar (psig)
			L	B	F	
6	1.0	-WT2-MTB6	31.2 (1.23)	19.1 (0.75)	11.1 (7/16)	420 (6095)
8	1.0	-WT2-MTB8	31.2 (1.23)	19.1 (0.75)	11.1 (7/16)	310 (4499)
10	1.0	-WT2-MTB10	34.0 (1.34)	19.1 (0.75)	17.5 (11/16)	240 (3483)
12	1.0	-WT2-MTB12	34.0 (1.34)	19.1 (0.75)	17.5 (11/16)	200 (2902)
18	1.5	-WT2-MTB18	37.6 (1.48)	19.1 (0.75)	23.8 (15/16)	200 (2902)

Reducing Tees

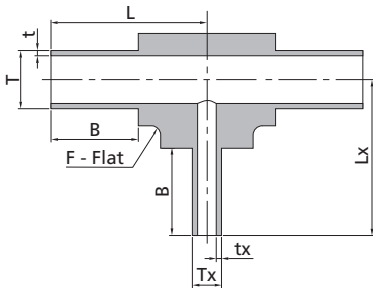

T-Tube O.D. (in.)	t-Wall Thickness (in.)	Tx-Tube O.D. (in.)	tx-Wall Thickness (in.)	Basic Ordering Number	Dimensions, in. (mm)				Working Pressure psig (bar)
					L	Lx	B	F	
3/8	0.035	1/4	0.035	-WT2-TB6-TB6-TB4	1.20 (30.5)	1.23 (31.2)	0.75 (19.1)	7/16 (11.1)	3300 (227)
1/2	0.049	1/4	0.035	-WT2-TB8-TB8-TB4	1.34 (34.0)	1.34 (34.0)	0.75 (19.1)	11/16 (17.5)	3700 (254)
1/2	0.049	3/8	0.035	-WT2-TB8-TB8-TB6	1.34 (34.0)	1.35 (34.3)	0.75 (19.1)	11/16 (17.5)	3700 (254)
3/4	0.049	1/4	0.035	-WT2-TB12-TB12-TB4	1.46 (37.1)	1.48 (37.6)	0.75 (19.1)	15/16 (23.8)	2400 (165)
3/4	0.049	3/8	0.035	-WT2-TB12-TB12-TB6	1.46 (37.1)	1.35 (34.3)	0.75 (19.1)	15/16 (23.8)	2400 (165)

T-Tube O.D. (mm)	t-Wall Thickness (mm)	Tx-Tube O.D. (mm)	tx-Wall Thickness (mm)	Basic Ordering Number	Dimensions, mm (in.)				Working Pressure bar (psig)
					L	Lx	B	F	
8	1.0	6	1.0	-WT2-MTB8-MTB8-MTB6	31.3 (1.23)	31.3 (1.23)	19.1 (0.75)	11.1 (7/16)	310 (4499)
10	1.0	6	1.0	-WT2-MTB10-MTB10-MTB6	34.0 (1.34)	34.0 (1.34)	19.1 (0.75)	17.5 (11/16)	240 (3483)
10	1.0	8	1.0	-WT2-MTB10-MTB10-MTB8	34.0 (1.34)	34.0 (1.34)	19.1 (0.75)	17.5 (11/16)	240 (3483)
12	1.0	6	1.0	-WT2-MTB12-MTB12-MTB6	34.0 (1.34)	34.0 (1.34)	19.1 (0.75)	17.5 (11/16)	200 (2902)
12	1.0	8	1.0	-WT2-MTB12-MTB12-MTB8	34.0 (1.34)	34.0 (1.34)	19.1 (0.75)	17.5 (11/16)	200 (2902)

Union Crosses

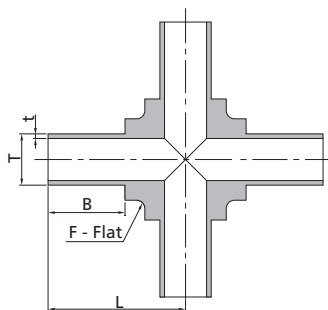

T-Tube O.D. (in.)	t-Wall Thickness (in.)	Basic Ordering Number	Dimensions, in. (mm)			Working Pressure psig (bar)
			L	B	F	
1/4	0.035	-WC2-TB4	1.23 (31.2)	0.75 (19.1)	7/16 (11.1)	5100 (351)
3/8	0.035	-WC2-TB6	1.20 (30.5)	0.75 (19.1)	7/16 (11.1)	3300 (227)
1/2	0.049	-WC2-TB8	1.34 (34.0)	0.75 (19.1)	11/16 (17.5)	3700 (254)

T-Tube O.D. (mm)	t-Wall Thickness (mm)	Basic Ordering Number	Dimensions, mm (in.)			Working Pressure bar (psig)
			L	B	F	
6	1.0	-WC2-MTB6	31.2 (1.23)	19.1 (0.75)	11.1 (7/16)	420 (6095)
8	1.0	-WC2-MTB8	31.2 (1.23)	19.1 (0.75)	11.1 (7/16)	310 (4499)
10	1.0	-WC2-MTB10	34.0 (1.34)	19.1 (0.75)	15.9 (5/8)	240 (3483)
12	1.0	-WC2-MTB12	34.0 (1.34)	19.1 (0.75)	15.9 (5/8)	200 (2902)

Weld Rings

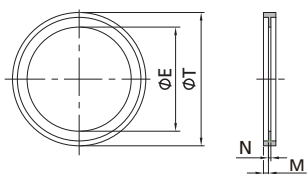

T-Tube O.D. (in.)	Basic Ordering Number	Dimensions, in. (mm)			
		E	M	N	T
1/4	-WR-4	0.20 (5.1)	0.02 (0.51)	0.01 (0.25)	0.28 (7.1)
3/8	-WR-6	0.32 (8.1)	0.02 (0.51)	0.01 (0.25)	0.41 (10.4)
1/2	-WR-8	0.42 (10.7)	0.02 (0.51)	0.01 (0.25)	0.54 (13.7)

A Series Automatic Tube Butt Weld Fittings

Features

- Extended tube design with locating ring
- Machined from forging blanks except for straight configurations
- Sizes range from 1/4" to 1" and 6 mm to 18 mm



Locator Unions

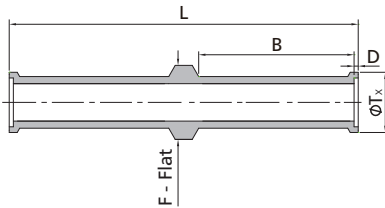

Tube O.D. (in.)	Wall Thickness (in.)	Basic Ordering Number	Dimensions, in. (mm)					Working Pressure psig (bar)
			L	B	D	F	T _x	
1/4	0.035	-WU2-L-TB4A	1.69 (42.9)	0.75 (19.1)	0.02 (0.5)	0.36 (9.1)	0.29 (7.4)	5100 (351)
3/8	0.035	-WU2-L-TB6A	1.71 (43.4)	0.75 (19.1)	0.03 (0.8)	0.42 (10.7)	0.41 (10.4)	3300 (227)
1/2	0.049	-WU2-L-TB8A	1.73 (43.9)	0.75 (19.1)	0.04 (1.0)	0.60 (15.2)	0.55 (14.0)	3700 (254)

Unions

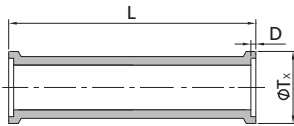

Tube O.D. (in.)	Wall Thickness (in.)	Basic Ordering Number	Dimensions, in. (mm)			Working Pressure psig (bar)
			L	D	T _x	
1/4	0.035	-WU2-TB4A	1.00 (25.4)	0.02 (0.5)	0.29 (7.4)	5100 (351)
3/8	0.035	-WU2-TB6A	1.00 (25.4)	0.03 (0.8)	0.41 (10.4)	3300 (227)
1/2	0.049	-WU2-TB8A	1.00 (25.4)	0.04 (1.0)	0.55 (14.0)	3700 (254)
3/4	0.049	-WU2-TB12A	1.00 (25.4)	0.04 (1.0)	0.80 (20.3)	2400 (165)
1	0.065	-WU2-TB16A	1.25 (31.8)	0.04 (1.0)	1.06 (26.9)	2400 (165)

Tube O.D. (in.)	Wall Thickness (in.)	Basic Ordering Number	Dimensions, mm (in.)			Working Pressure bar (psig)
			L	D	T _x	
6	1	-WU2-MTB6A	31.8 (1.25)	0.5 (0.02)	6.9 (0.27)	420 (6095)
8	1	-WU2-MTB8A	31.8 (1.25)	0.8 (0.03)	8.9 (0.35)	310 (4499)
10	1	-WU2-MTB10A	31.8 (1.25)	0.8 (0.03)	10.9 (0.43)	240 (3483)
12	1	-WU2-MTB12A	31.8 (1.25)	1.0 (0.04)	13.2 (0.52)	200 (2902)
18	1.5	-WU2-MTB18A	31.8 (1.25)	1.0 (0.04)	19.3 (0.76)	200 (2902)

Reducing Unions

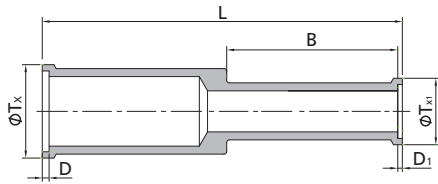

Tube O.D. (in.)	Wall Thickness (in.)	Tube O.D. (in.)	Wall Thickness (in.)	Basic Ordering Number	Dimensions, in. (mm)						Working Pressure psig (bar)
					L	B	D	D ₁	T _x	T _{x1}	
3/8	0.035	1/4	0.035	-WU2-TB6A-TB4A	1.58 (40.1)	0.75 (19.1)	0.03 (0.8)	0.02 (0.5)	0.41 (10.4)	0.29 (7.4)	3300 (227)
1/2	0.049	1/4	0.035	-WU2-TB8A-TB4A	1.58 (40.1)	0.75 (19.1)	0.04 (1.0)	0.02 (0.5)	0.55 (14.0)	0.29 (7.4)	3700 (254)
1/2	0.049	3/8	0.035	-WU2-TB8A-TB6A	1.58 (40.1)	0.75 (19.1)	0.04 (1.0)	0.03 (0.8)	0.55 (14.0)	0.41 (10.4)	3300 (227)
3/4	0.049	1/2	0.049	-WU2-TB12A-TB8A	1.62 (41.1)	0.75 (19.1)	0.04 (1.0)	0.04 (1.0)	0.80 (20.3)	0.55 (14.0)	2400 (165)

Tube O.D. (mm)	Wall Thickness (mm)	Tube O.D. (mm)	Wall Thickness (mm)	Basic Ordering Number	Dimensions, mm (in.)						Working Pressure bar (psig)
					L	B	D	D ₁	T _x	T _{x1}	
8	1	6	1	-WU2-MTB8A-MTB6A	39.9 (1.57)	19.1 (0.75)	0.8 (0.03)	0.5 (0.02)	8.90 (0.35)	6.8 (0.27)	310 (4499)
12	1	6	1	-WU2-MTB12A-MTB6A	40.1 (1.58)	19.1 (0.75)	1.0 (0.04)	0.5 (0.02)	13.2 (0.52)	6.8 (0.27)	200 (2902)
12	1	8	1	-WU2-MTB12A-MTB8A	40.4 (1.59)	19.1 (0.75)	1.0 (0.04)	0.8 (0.03)	13.2 (0.52)	8.9 (0.35)	200 (2902)

90° Union Elbows

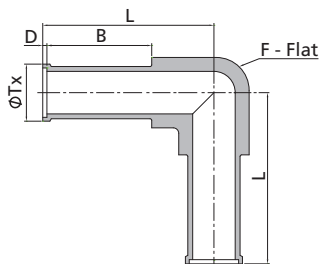

Tube O.D. (in.)	Wall Thickness (in.)	Basic Ordering Number	Dimensions, in. (mm)					Working Pressure psig (bar)
			L	B	D	F	T _x	
1/4	0.035	-WL2-TB4A	1.25 (31.8)	0.75 (19.1)	0.02 (0.5)	7/16 (11.1)	0.29 (7.4)	5100 (351)
3/8	0.035	-WL2-TB6A	1.23 (31.2)	0.75 (19.1)	0.03 (0.8)	7/16 (11.1)	0.41 (10.4)	3300 (227)
1/2	0.049	-WL2-TB8A	1.38 (35.1)	0.75 (19.1)	0.04 (1.0)	11/16 (17.5)	0.55 (14.0)	3700 (254)
3/4	0.049	-WL2-TB12A	1.50 (38.1)	0.75 (19.1)	0.04 (1.0)	15/16 (23.8)	0.80 (20.3)	2400 (165)

Tube O.D. (mm)	Wall Thickness (mm)	Basic Ordering Number	Dimensions, mm (in.)					Working Pressure bar (psig)
			L	B	D	F	T _x	
6	1	-WL2-MTB6A	31.8 (1.25)	19.1 (0.75)	0.5 (0.02)	11.1 (7/16)	6.90 (0.27)	351 (5100)
8	1	-WL2-MTB8A	32.0 (1.26)	19.1 (0.75)	0.8 (0.03)	11.1 (7/16)	8.90 (0.35)	227 (3300)
10	1	-WL2-MTB10A	34.8 (1.37)	19.1 (0.75)	0.8 (0.03)	17.5 (11/16)	10.9 (0.43)	254 (3700)
12	1	-WL2-MTB12A	35.1 (1.38)	19.1 (0.75)	1.0 (0.04)	17.5 (11/16)	13.2 (0.52)	199 (2888)
18	1.5	-WL2-MTB18A	38.6 (1.52)	19.1 (0.75)	1.0 (0.04)	23.8 (15/16)	19.3 (0.76)	206 (2989)

Union Tees

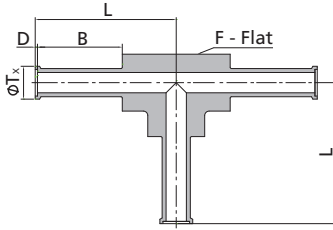

Tube O.D. (in.)	Wall Thickness (in.)	Basic Ordering Number	Dimensions, in. (mm)					Working Pressure psig (bar)
			L	B	D	F	T _x	
1/4	0.035	-WT2-TB4A	1.25 (31.8)	0.75 (19.1)	0.02 (0.5)	7/16 (11.1)	0.29 (7.4)	5100 (351)
3/8	0.035	-WT2-TB6A	1.23 (31.2)	0.75 (19.1)	0.03 (0.8)	7/16 (11.1)	0.41 (10.4)	3300 (227)
1/2	0.049	-WT2-TB8A	1.38 (35.1)	0.75 (19.1)	0.04 (1.0)	11/16 (17.5)	0.55 (14.0)	3500 (241)
3/4	0.049	-WT2-TB12A	1.50 (38.1)	0.75 (19.1)	0.04 (1.0)	15/16 (23.8)	0.80 (20.3)	2400 (165)

Tube O.D. (mm)	Wall Thickness (mm)	Basic Ordering Number	Dimensions, mm (in.)					Working Pressure bar (psig)
			L	B	D	F	T _x	
6	1	-WT2-MTB6A	31.8 (1.25)	19.1 (0.75)	0.5 (0.02)	11.1 (7/16)	6.90 (0.27)	454 (6589)
8	1	-WT2-MTB8A	32.0 (1.26)	19.1 (0.75)	0.8 (0.03)	11.1 (7/16)	8.90 (0.35)	323 (4687)
10	1	-WT2-MTB10A	34.8 (1.37)	19.1 (0.75)	0.8 (0.03)	17.5 (11/16)	10.9 (0.43)	254 (3686)
12	1	-WT2-MTB12A	35.1 (1.38)	19.1 (0.75)	1.0 (0.04)	17.5 (11/16)	13.2 (0.52)	206 (2989)
18	1.5	-WT2-MTB18A	38.6 (1.52)	19.1 (0.75)	1.0 (0.04)	23.8 (15/16)	19.3 (0.76)	206 (2989)

Reducing Tees

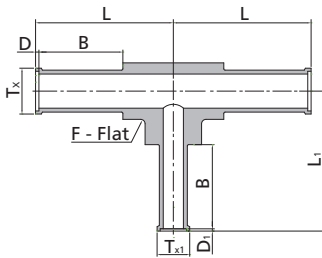

Tube O.D. (in.)	Wall Thickness (in.)	Tube O.D. (in.)	Wall Thickness (in.)	Basic Ordering Number	Dimensions, in. (mm)								Working Pressure psig (bar)
					L	L1	B	D	D1	T _x	T _{x1}	F	
3/8	0.035	1/4	0.035	-WT2-TB6A-TB6A-TB4A	1.23 (31.2)	1.25 (31.8)	0.75 (19.1)	0.03 (0.8)	0.02 (0.5)	0.41 (10.4)	0.29 (7.4)	7/16 (11.1)	3300 (227)
1/2	0.049	1/4	0.035	-WT2-TB8A-TB8A-TB4A	1.38 (35.1)	1.38 (35.1)	0.75 (19.1)	0.04 (1.0)	0.02 (0.5)	0.55 (14.0)	0.29 (7.4)	11/16 (17.5)	3700 (254)
1/2	0.049	3/8	0.035	-WT2-TB8A-TB8A-TB6A	1.38 (35.1)	1.37 (34.8)	0.75 (19.1)	0.04 (1.0)	0.03 (0.8)	0.55 (14.0)	0.41 (10.4)	11/16 (17.5)	3300 (227)
3/4	0.049	3/8	0.035	-WT2-TB12A-TB12A-TB6A	1.50 (38.1)	1.50 (38.1)	0.75 (19.1)	0.04 (1.0)	0.03 (0.8)	0.80 (20.3)	0.41 (10.4)	15/16 (23.8)	2400 (165)
3/4	0.049	1/2	0.049	-WT2-TB12A-TB12A-TB8A	1.50 (38.1)	1.50 (38.1)	0.75 (19.1)	0.04 (1.0)	0.04 (1.0)	0.80 (20.3)	0.55 (14.0)	15/16 (23.8)	2400 (165)

Tube O.D. (mm)	Wall Thickness (mm)	Tube O.D. (mm)	Wall Thickness (mm)	Basic Ordering Number	Dimensions, mm (in.)								Working Pressure bar (psig)
					L	L1	B	D	D1	T _x	T _{x1}	F	
12	1	6	1	-WT2-MTB12A-MTB12A-MTB6A	35.1 (1.38)	34.5 (1.36)	19.1 (0.75)	0.5 (0.02)	0.5 (0.02)	13.2 (0.52)	6.9 (0.27)	17.5 (11/16)	200 (2902)

Manifold Tees

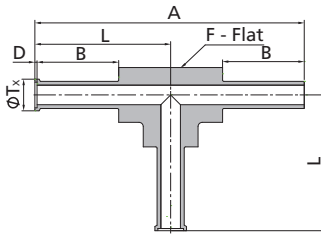

Tube O.D. (in.)	Wall Thickness (in.)	Basic Ordering Number	Dimensions, in. (mm)						Working Pressure psig (bar)
			A	L	B	D	F	T _x	
1/4	0.035	-WT2-TB4A-TB4-TB4A	2.48 (63.0)	1.25 (31.8)	0.75 (19.1)	0.02 (0.5)	7/16 (11.1)	0.29 (7.4)	5100 (351)
3/8	0.035	-WT2-TB6A-TB6-TB6A	2.43 (61.7)	1.23 (31.2)	0.75 (19.1)	0.03 (0.8)	11/16 (17.5)	0.41 (10.4)	3300 (227)
1/2	0.049	-WT2-TB8A-TB8-TB8A	2.72 (69.1)	1.38 (35.1)	0.75 (19.1)	0.04 (1.0)	11/16 (17.5)	0.55 (14.0)	3700 (254)

Reducing Tees

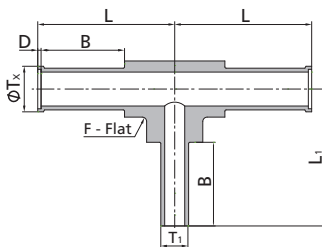

Tube O.D. (in.)	Wall Thickness (in.)	Tube O.D. (in.)	Wall Thickness (in.)	Basic Ordering Number	Dimensions, in. (mm)						Working Pressure psig (bar)
					L	L ₁	B	D	T _x	F	
3/8	0.035	1/4	0.035	-WT2-TB6A-TB6A-TB4	1.23 (31.2)	1.23 (31.2)	0.75 (19.1)	0.03 (0.8)	0.41 (10.4)	7/16 (11.1)	3300 (227)
1/2	0.049	1/4	0.035	-WT2-TB8A-TB8A-TB4	1.38 (35.1)	1.36 (34.5)	0.75 (19.1)	0.04 (1.0)	0.55 (14.0)	11/16 (17.5)	3700 (254)
1/2	0.049	3/8	0.035	-WT2-TB8A-TB8A-TB6	1.38 (35.1)	1.35 (34.3)	0.75 (19.1)	0.04 (1.0)	0.55 (14.0)	11/16 (17.5)	3300 (227)

Union Crosses

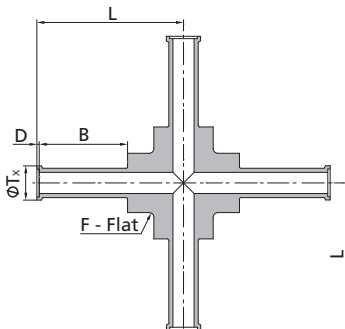

Tube O.D. (in.)	Wall Thickness (in.)	Basic Ordering Number	Dimensions, in. (mm)					Working Pressure psig (bar)
			L	B	D	F	T _x	
1/4	0.035	-WC2-TB4A	1.25 (31.8)	0.75 (19.1)	0.02 (0.5)	7/16 (11.1)	0.29 (7.4)	5100 (351)
3/8	0.035	-WC2-TB6A	1.23 (31.2)	0.75 (19.1)	0.03 (0.8)	7/16 (11.1)	0.41 (10.4)	3300 (227)
1/2	0.049	-WC2-TB8A	1.35 (34.3)	0.75 (19.1)	0.04 (1.0)	5/8 (17.5)	0.55 (14.0)	3700 (254)

Tube O.D. (mm)	Wall Thickness (mm)	Basic Ordering Number	Dimensions, mm (in.)					Working Pressure bar (psig)
			L	B	D	F	T _x	
6	1	-WC2-MTB6A	31.8 (1.25)	19.1 (0.75)	0.5 (0.02)	11.1 (7/16)	6.9 (0.27)	420 (6095)
8	1	-WC2-MTB8A	31.8 (1.25)	19.1 (0.75)	0.8 (0.03)	11.1 (7/16)	8.9 (0.35)	310 (4499)

T Series Tubular Fittings

Features

- 316L Stainless Steel
- Sizes range from 1/4" to 2"
- Available in a variety of configurations



Concentric Reducings

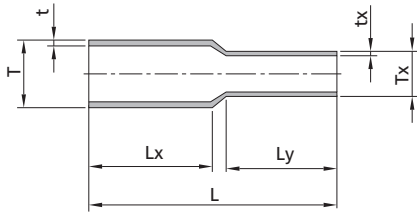

T-Tube O.D. (in.)	t-Wall Thickness (in.)	Tx-Tube O.D. (in.)	tx-Wall Thickness (in.)	Ordering Number	Dimensions, in. (mm)			Working Pressure psig (bar)
					L	Lx	Ly	
3/8	0.035	1/4	0.035	6L-WU3-TB6-TB4	2.75 (69.9)	1.37 (34.8)	1.16 (29.5)	3330 (230)
1/2	0.049	1/4	0.035	6L-WU3-TB8-TB4	2.75 (69.9)	1.37 (34.8)	0.94 (23.9)	3530 (243)
1/2	0.049	3/8	0.035	6L-WU3-TB8-TB6	2.75 (69.9)	1.37 (34.8)	1.16 (29.5)	3330 (230)
3/4	0.065	1/4	0.035	6L-WU3-TB12-TB4	2.75 (69.9)	1.37 (34.8)	1.09 (27.7)	3330 (230)
3/4	0.065	3/8	0.035	6L-WU3-TB12-TB6	2.75 (69.9)	1.37 (34.8)	1.16 (29.5)	3330 (230)
3/4	0.065	1/2	0.049	6L-WU3-TB12-TB8	2.75 (69.9)	1.37 (34.8)	1.23 (31.2)	3330 (230)
1	0.065	1/4	0.035	6L-WU3-TB16-TB4	3.00 (76.2)	1.50 (38.1)	1.07 (27.2)	2420 (167)
1	0.065	3/8	0.035	6L-WU3-TB16-TB6	3.00 (76.2)	1.50 (38.1)	1.14 (29.0)	2420 (167)
1	0.065	1/2	0.049	6L-WU3-TB16-TB8	3.00 (76.2)	1.50 (38.1)	1.21 (30.7)	2420 (167)
1	0.065	3/4	0.065	6L-WU3-TB16-TB12	3.00 (76.2)	1.50 (38.1)	1.35 (34.3)	2420 (167)
1 1/2	0.065	1/4	0.035	6L-WU3-TB24-TB4	5.50 (140.0)	1.50 (38.1)	1.50 (38.1)	1550 (107)
1 1/2	0.065	3/8	0.035	6L-WU3-TB24-TB6	5.50 (140.0)	1.50 (38.1)	1.50 (38.1)	1550 (107)
1 1/2	0.065	1/2	0.049	6L-WU3-TB24-TB8	5.50 (140.0)	1.50 (38.1)	1.50 (38.1)	1550 (107)
1 1/2	0.065	3/4	0.065	6L-WU3-TB24-TB12	5.00 (127.0)	1.50 (38.1)	1.50 (38.1)	1550 (107)
1 1/2	0.065	1	0.065	6L-WU3-TB24-TB16	5.00 (127.0)	1.50 (38.1)	1.50 (38.1)	1160 (80)
2	0.065	1/4	0.035	6L-WU3-TB32-TB4	7.75 (197.0)	1.75 (44.5)	1.50 (38.1)	1160 (80)
2	0.065	3/8	0.035	6L-WU3-TB32-TB6	7.75 (197.0)	1.75 (44.5)	1.50 (38.1)	1160 (80)
2	0.065	1/2	0.049	6L-WU3-TB32-TB8	7.75 (197.0)	1.75 (44.5)	1.50 (38.1)	1160 (80)
2	0.065	3/4	0.065	6L-WU3-TB32-TB12	7.25 (184.0)	1.75 (44.5)	1.50 (38.1)	1160 (80)
2	0.065	1	0.065	6L-WU3-TB32-TB16	7.25 (184.0)	1.75 (44.5)	1.50 (38.1)	1160 (80)
2	0.065	1 1/2	0.065	6L-WU3-TB32-TB24	5.25 (133.0)	1.75 (44.5)	1.50 (38.1)	1160 (80)

90° Elbows

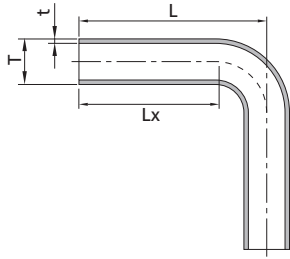

T-Tube O.D. (in.)	t-Wall Thickness (in.)	Ordering Number	Dimensions, in. (mm)		Working Pressure psig (bar)
			L	Lx	
1/4	0.035	6L-WL3-TB4	2.06 (52.3)	1.50 (38.1)	5150 (355)
3/8	0.035	6L-WL3-TB6	2.62 (66.5)	2.06 (52.3)	3330 (230)
1/2	0.049	6L-WL3-TB8	2.62 (66.5)	1.87 (47.5)	3530 (243)
3/4	0.065	6L-WL3-TB12	2.60 (66.0)	1.42 (36.0)	3330 (230)
1	0.065	6L-WL3-TB16	3.00 (76.2)	1.50 (38.1)	2420 (167)
1 1/2	0.065	6L-WL3-TB24	3.75 (95.3)	1.50 (38.1)	1550 (107)
2	0.065	6L-WL3-TB32	4.75 (120.7)	1.75 (44.5)	1160 (80)

45° Elbows

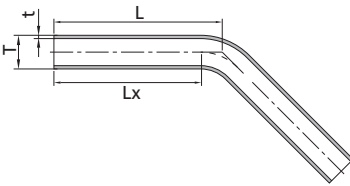

T-Tube O.D. (in.)	t-Wall Thickness (in.)	Ordering Number	Dimensions, in. (mm)		Working Pressure psig (bar)
			L	Lx	
1/4	0.035	6L-WV3-TB4	1.10 (27.9)	0.86 (21.8)	5150 (355)
3/8	0.035	6L-WV3-TB6	2.00 (50.8)	1.76 (44.7)	3330 (230)
1/2	0.049	6L-WV3-TB8	2.50 (63.5)	2.18 (55.4)	3530 (243)
3/4	0.065	6L-WV3-TB12	1.93 (49.0)	1.46 (37.1)	3330 (230)
1	0.065	6L-WV3-TB16	2.25 (57.2)	1.63 (41.4)	2420 (167)
1 1/2	0.065	6L-WV3-TB24	2.50 (63.5)	1.50 (38.1)	1550 (107)
2	0.065	6L-WV3-TB32	3.00 (76.2)	1.75 (44.5)	1160 (80)

Tees

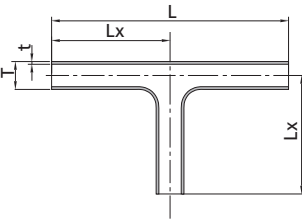

T-Tube O.D. (in.)	t-Wall Thickness (in.)	Ordering Number	Dimensions, in. (mm)		Working Pressure psig (bar)
			L	Lx	
1/4	0.035	6L-WT3-TB4	3.54 (90.0)	1.77 (45.0)	5150 (355)
3/8	0.035	6L-WT3-TB6	3.54 (90.0)	1.77 (45.0)	3330 (230)
1/2	0.049	6L-WT3-TB8	3.54 (90.0)	1.77 (45.0)	3530 (243)
3/4	0.065	6L-WT3-TB12	4.09 (104.0)	2.05 (52.0)	3330 (230)
1	0.065	6L-WT3-TB16	4.33 (110.0)	2.17 (55.0)	2420 (167)
1 1/2	0.065	6L-WT3-TB24	5.83 (148.0)	2.91 (74.0)	1550 (107)
2	0.065	6L-WT3-TB32	6.06 (154.0)	3.07 (78.0)	1160 (80)

Reducing Tees

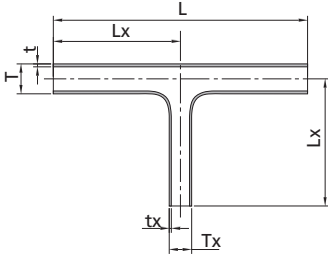

T-Tube O.D. (in.)	t-Wall Thickness (in.)	Tx-Tube O.D. (in.)	tx-Wall Thickness (in.)	Ordering Number	Dimensions, in. (mm)		Working Pressure psig (bar)
					L	Lx	
3/8	0.035	1/4	0.035	6L-WT3-TB6-TB6-TB4	3.54 (90.0)	1.77 (45.0)	3330 (230)
1/2	0.049	1/4	0.035	6L-WT3-TB8-TB8-TB4	3.54 (90.0)	1.77 (45.0)	3530 (243)
1/2	0.049	3/8	0.035	6L-WT3-TB8-TB8-TB6	3.54 (90.0)	1.77 (45.0)	3330 (230)
3/4	0.065	1/4	0.035	6L-WT3-TB12-TB12-TB4	3.70 (94.0)	1.73 (44.0)	3330 (230)
3/4	0.065	3/8	0.035	6L-WT3-TB12-TB12-TB6	3.70 (94.0)	1.73 (44.0)	3330 (230)
3/4	0.065	1/2	0.049	6L-WT3-TB12-TB12-TB8	3.70 (94.0)	1.73 (44.0)	3330 (230)
1	0.065	1/4	0.035	6L-WT3-TB16-TB16-TB4	3.70 (94.0)	1.85 (47.0)	2420 (167)
1	0.065	3/8	0.035	6L-WT3-TB16-TB16-TB6	3.70 (94.0)	1.85 (47.0)	2420 (167)
1	0.065	1/2	0.049	6L-WT3-TB16-TB16-TB8	3.70 (94.0)	1.85 (47.0)	2420 (167)
1	0.065	3/4	0.065	6L-WT3-TB16-TB16-TB12	4.33 (110.0)	2.17 (55.0)	2420 (167)
1 1/2	0.065	1/4	0.035	6L-WT3-TB24-TB24-TB4	4.49 (114.0)	2.13 (54.0)	1550 (107)
1 1/2	0.065	3/8	0.035	6L-WT3-TB24-TB24-TB6	4.49 (114.0)	2.13 (54.0)	1550 (107)
1 1/2	0.065	1/2	0.049	6L-WT3-TB24-TB24-TB8	4.49 (114.0)	2.13 (54.0)	1550 (107)
1 1/2	0.065	3/4	0.065	6L-WT3-TB24-TB24-TB12	5.35 (136.0)	2.44 (62.0)	1550 (107)
1 1/2	0.065	1	0.065	6L-WT3-TB24-TB24-TB16	5.35 (136.0)	2.44 (62.0)	1550 (107)
2	0.065	1/4	0.035	6L-WT3-TB32-TB32-TB4	4.49 (114.0)	2.24 (57.0)	1160 (80)
2	0.065	3/8	0.035	6L-WT3-TB32-TB32-TB6	4.49 (114.0)	2.24 (57.0)	1160 (80)
2	0.065	1/2	0.049	6L-WT3-TB32-TB32-TB8	4.49 (114.0)	2.24 (57.0)	1160 (80)
2	0.065	3/4	0.065	6L-WT3-TB32-TB32-TB12	5.35 (136.0)	2.56 (65.0)	1160 (80)
2	0.065	1	0.065	6L-WT3-TB32-TB32-TB16	5.35 (136.0)	2.56 (65.0)	1160 (80)
2	0.065	1 1/2	0.065	6L-WT3-TB32-TB32-TB24	6.06 (154.0)	3.03 (77.0)	1160 (80)

End Caps

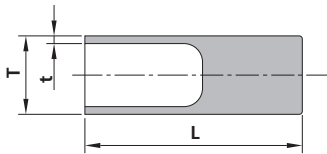

T-Tube O.D. (in.)	t-Wall Thickness (in.)	Ordering Number	Dimensions, in. (mm)	Working Pressure psig (bar)
			L	
1/4	0.035	6L-CW3-TB4	1.12 (28.4)	5150 (355)
3/8	0.035	6L-CW3-TB6	1.12 (28.4)	3330 (230)
1/2	0.049	6L-CW3-TB8	1.37 (34.8)	3530 (243)
3/4	0.065	6L-CW3-TB12	1.75 (44.5)	3330 (230)
1	0.065	6L-CW3-TB16	1.75 (44.5)	2420 (167)
1 1/2	0.065	6L-CW3-TB24	2.00 (50.8)	1550 (167)
2	0.065	6L-CW3-TB32	2.00 (50.8)	1160 (80)