

Flex Circuits Design Guide



FLEX CIRCUIT SOLUTIONS

Design Guidelines for Highly Reliable Flexible Printed Circuits Optimized for Manufacturability

The purpose of this design guide is to enable you to design a highly reliable, flexible printed circuit optimized for manufacturability.

While using this guide, keep in mind that the design information provided is only a suggestion. Minco takes pride in manufacturing flex circuits that are considered difficult to build. In most cases, we do build above and beyond the “standard” circuit specifications, provided that the circuit design and type allow for it.

Table of Contents

Table of Contents.....	2	How to improve flexibility and bend radius.....	16
Types of Flex circuits	3	Holes	17
The Minco Difference	4	Conductor width, thickness, and spacing.....	20
How to Get Started	4	Materials	21
Understand How Flex Circuits Work.....	4	Value Added Design Options	22
Build a Flex Circuit Mock-up.....	4	Terminations	22
Consider a Mechanical Sample	4	Stiffeners	23
Benefits of Flex Circuits	5	Forming	24
High reliability	5	Population.....	24
Superior packaging options	5	Custom and Integrated Components.....	25
Design Options	7	Request a Quote	26
Design Guidelines.....	8	Providing information for a quote	26
Specification documents:.....	8	Specify testing requirements	26
Manufacturing a flex circuit.....	9	Artwork checklist.....	26
Cost impact of layer count.....	9	Designing CAD artworks.....	27
Circuit types.....	10	CAD/CAM data guidelines	28
Minco’s General Capabilities.....	12	E2E — Engineer to Engineer	28
Standard specifications	12	Early engineering involvement.....	28
Testing.....	13	Ordering and Delivery	28
Marking.....	13	Place your order with Minco	28
Control impedance and electrical noise.....	14	Delivery information	28
Conductor width nomograph	14	Glossary	29
Conductor aspect ratio	14	Next Steps.....	32
Assumptions.....	14		
Conductor width nomograph	15		
Standard Design Recommendations	16		
Design differences and special considerations.....	16		

Types of Flex Circuits

- **Flex:** Flexible version of a Printed Circuit Board (PCB), with unique capabilities. Flex circuits offer the same advantages of a printed circuit board: repeatability, reliability, and high density but with the added “twist” of flexibility and vibration resistance. The most important attribute compelling designers to adopt flex circuit technology is the capability of the flex circuit to assume three-dimensional configurations.

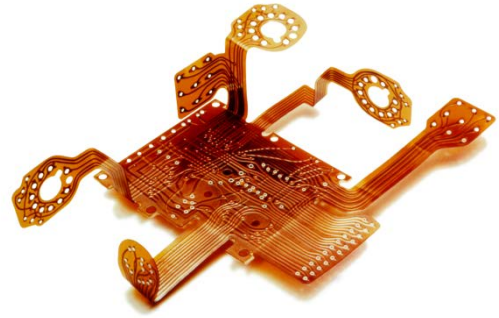

- **Rigid-flex:** A blend of rigid and flex emphasizing the best of both constructions, adding synergistic capabilities neither possess alone. In its most typical configuration, the rigid-flex is a series of rigid PCBs joined by integrated flex circuits (with emphasis on the high percentage of rigid area content). Circuits designed primarily as flex circuits have great opportunities to increase your design capabilities when integrated rigid areas are added.

Rigid areas provide excellent hard mount points for components, connectors and chassis while flex areas offer dynamic flexing, flex to fit, and component mounting poised to take advantage of these low mass and vibration resistant zones. This blending leads to creative solutions for your most demanding applications.



- **High Density Interconnect (HDI):** High Density Interconnect (HDI) flexible circuits offer increased design, layout and construction options over typical flexible circuits. Each High Density Interconnect incorporates microvias and fine features to achieve highly dense flex circuitry, smaller form factor and increased functionality. This technology offers better electrical performance, access to advanced integrated circuit (IC) package use, and improved reliability through the use of microvias and thinner materials.

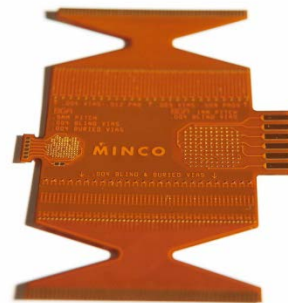

- **Flex-Coils™:** Custom wire-wound or etched coils may be integrated with any of our flex circuit or rigid-flex board types. Whether bonded to the surface or encapsulated in a high dielectric and abrasion resistant covering, these assemblies offer special capabilities to your coil designs.



The Minco Difference

Minco provides comprehensive design and engineering services, partnering with you at every step of your product life cycle. The Minco difference includes:

- Minco engineers serve as an extension of your engineering organization
- Building partnerships to assure early involvement in the product cycle and a clear understanding of your program needs
- Disciplined New Product Introduction (NPI) approach supports fewer product iterations.
- Solutions oriented engineering staff with extensive experience in successfully designing products.

How to Get Started

Understand How Flex Circuits Work

Carefully review the information in this guide and other online resources at www.minco.com. Knowledge of flex circuit types, capabilities and applications will provide the guidelines you need to design the best flex circuit for your product needs.

Build a Flex Circuit Mock-up

The dynamic nature of flex circuits allows for a multitude of design options. The best method for determining the validity of your design is to create a physical flex circuit mock up. To make your mock-up, follow these steps:

- Determine the system points to be electrically connected via flex circuitry and termination method(s), such as mating connectors, pins, ZIF, etc.
- Determine approximate circuit “footprint” that will provide conductor routing to each termination location.
- Review schematic or net list details along with special electrical requirements, such as plane layers, to determine approximate layer count.
- Examine sample circuits of similar layer counts to determine if the proposed design will provide sufficient flexibility
- Review mechanical requirements to ensure that bend radii fall within acceptable values for circuit thickness and layer count (refer to IPC-2223 for bend radius guidelines).
- If possible, construct a virtual mock-up of your flex circuit in its formed, installed state in a 3D CAD package (such as SolidWorks). This method allows

you to design the proper fitment for your specific application quickly and precisely, while allowing you to visualize all interference issues in your virtual application.

- Create a flattened 2D CAD part of the flex circuit.

Note: If you do not have a 3D CAD system, construct a “paper doll” outline of your flex circuit using heavy paper and check for fit. Make modifications as necessary. Continue constructing paper dolls and making modifications until the desired fit is achieved.

Use .010" (0.25mm) polyester film to reconstruct the paper doll to make a representative mock-up. Install and make any dimensional adjustments as necessary.

Your circuit outline is now complete and should be reconstructed in your CAD design software package. Using your circuit design software program, position connector footprints in the proper locations and route conductors per schematic or net list. Design rules for routing conductors on flexible circuits can be found in the IPC-2223 *Sectional Design Standard for Flexible Printed Boards*. You can also refer to the *Standard Design Recommendations* section in this guide.

Consider a Mechanical Sample

Minco will review your design for possible improvements. If there are questions about the proper fit of a new circuit, it is advisable to obtain a mechanical sample. This will allow you to ensure that your flex circuit has the right form and fit for your product. Form refers to the physical size, shape and mass of the part, while fit refers to its environmental interfaces, e.g. is it flexible enough to bend for installation, or will it meet temperature requirements? A mechanical sample can help you avoid installation problems or latent mechanical issues that could cause failures.

To receive a flex circuit mechanical sample proposal:

- Construct a simple 2-dimensional CAD model consisting of the circuit outline, and hole locations and sizes.
- Convert the CAD model to a 2-D DXF format and include a text file that provides the layer count, any special requirements, and a brief explanation of your application. Also include your name, company name, postal and email address, and phone number.
- Email this information to sales@minco.com.
- Minco will provide a response with a lead time for mechanical samples and advise if any charges are required.

Benefits of Flex Circuits

High reliability

Repeatable installation

Compared to discrete wiring, or ribbon cable, a flex circuit offers a customized repeatable routing path within your assembly. This gives you dependability where you need it. The longevity of a flex circuit can reduce service calls.

Harsh environments

Standard practice for flex boards is to cover the conductors with polyimide. This dielectric layer protects your circuits far beyond the capability of simple soldermask. Other base and cover materials are available for a broad range of ambient conditions.

Long duty cycles

By design, a flex circuit can be made very thin, yet robust enough to withstand thousands to millions of flexing cycles while carrying signal and power without a break.

High vibration

Under vibration and/or high acceleration, a flex circuit's ductility and low mass will reduce the impact upon itself and solder joints. By contrast, a PCB's higher vibrational mass will increase stresses upon itself, components and solder joints.



Before: A tangle of wires connects four circuit boards.

The flex circuit solution: A single circuit with 7 stiffeners and 2 connectors provides all the needed interconnects.

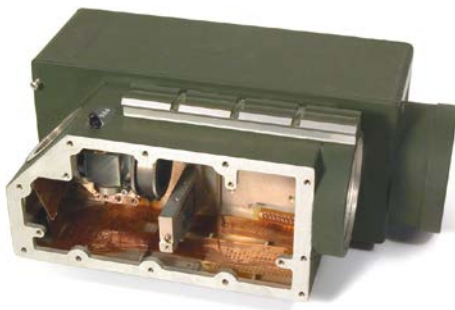

After: The package is neat, lightweight, and less susceptible to connection failure.

Superior packaging options

Flex circuits can be shaped to fit where no other design can. They are a hybrid of ordinary printed circuit boards and round wire, exhibiting benefits of each. In essence, flex circuits give you unlimited freedom of packaging geometry while retaining the precision density and repeatability of printed circuits.

Flex vs. wiring harness

- **Space and weight reduction:** A single flex circuit can replace several hardboards, cables, and connectors.
- **Fast assembly:** Flex circuits eliminate the need to color code and wrap bundles of wire, reducing the chance of assembly rejects and in-service failures. Total installed costs are lower, especially with volume production.
- **Repeatable wire routing:** Eliminate wire routing errors; reducing test time, rework, and rejects.
- **Robust connections:** Flat foil conductors dissipate heat better, carrying more current than round wires of the same cross-sectional area. Conductor patterns in a flex circuit maintain uniform electrical characteristics. Noise, crosstalk, and impedance can be predicted and controlled.

Flex vs. hard board (PCB)

- **Versatile shape:** The most important attribute compelling designers to adopt flex circuit technology is the capability of the flex circuit to assume three-dimensional configurations.
- **Lower mass:** With a little experimentation and imagination, a flex circuit can save up to 75% of the space and/or weight of conventional wiring.
- **Vibration resistance:** Recurring costs are lower than many wire harnesses, and since a flex circuit is more resistant to shock and vibrations than a PCB, repair and replacement costs are less.
- **Component mounting:** Surface mount component mounting on flex is achievable using selectively bonded stiffeners where required.

Rigid-flex

- **Double side component mounting:** Rigid-flex circuits are the ideal solution for flex circuits where surface mount components must be mounted on both sides of the board.
- **Total cost of ownership:** The maximum benefit of rigid-flex is realized when the complete installation is reviewed for total cost of ownership. Using rigid-flex eliminates connections in the flex-to-rigid transitions which can improve reliability and improve impedance control.
- **Most capable/Maximum vibration resistance:** Lets you integrate the best capabilities of resistant rigid areas and resilient flex areas.
- **High mass component mounting:** When mounting a high mass component, a rigid board is the right solution. A rigid-flex board gives you a smooth transition between rigid and flex areas while preserving the benefits of each.

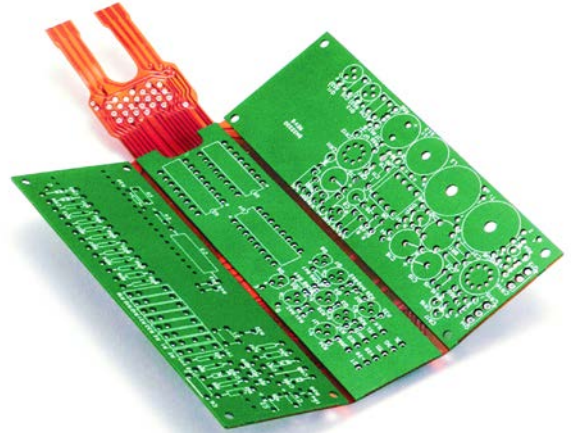

Flex-Coils™

- **Custom coil winding:** State of the art equipment generates a highly repeatable component.
- **Integrated assembly:** Allows best packaging of your fragile coil in a flex circuit sub-assembly.

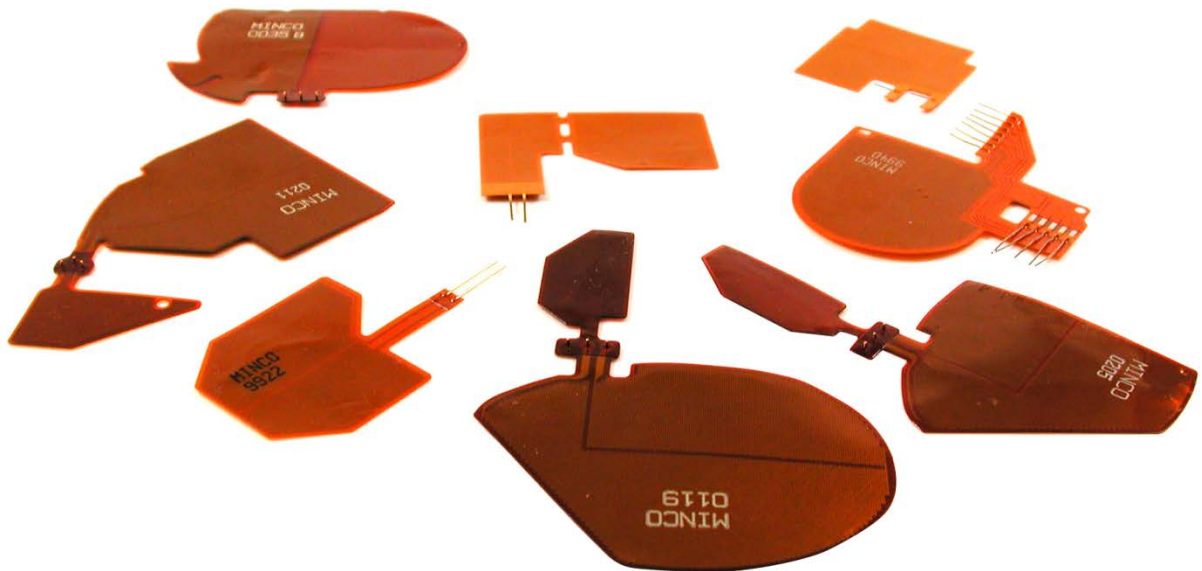

Design Options

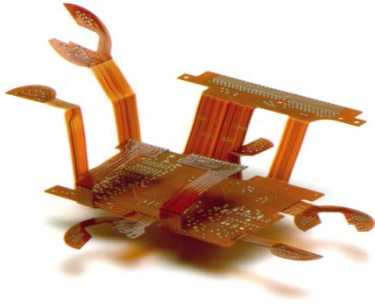

Rigid-flex

Hybrid hardboard/flex circuits can have up to sixteen layers. They replace bulky wire harnesses with a compact, robust design.

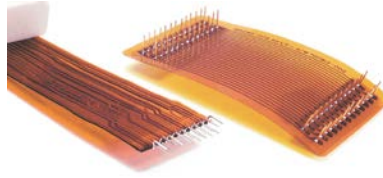

Pins

Minco can braze or solder pins to circuits, either through-holes or as extensions to conductors.

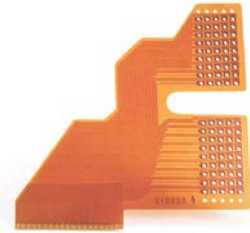

Fine lines

0.002" conductors and spaces are possible.

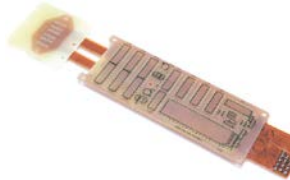

Stiffeners

An inexpensive alternative to rigid-flex.



Connectors

Built-in connectors speed your assembly. Optional epoxy potting creates a seal between the circuit and connector.

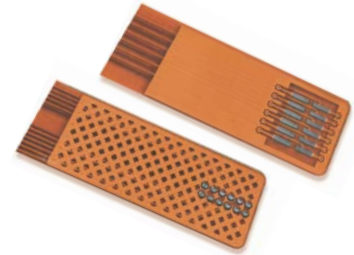

Shielding

Solid or patterned shield planes reduce noise and control impedance of signal lines. Use matched impedance flex circuits for high-speed signal integrity.



Assembly pallet

Stiffener material frames the circuit to hold it flat during assembly operations. After soldering or component placement, just clip out and install.



Factory form

Factory formed circuits follow tight curves to save space.

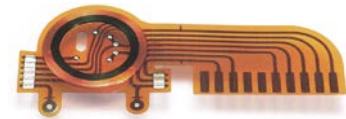

Coils

Minco's unique flat wound inductive coils can be laminated into flex circuits. Applications include pacemaker antennas and eddy current generators.



Surface mount

Combine the space and weight savings of surface mounting with those of flex circuits for the ultimate in high-density packaging.



Selective bonding

For better flexibility along circuit arms, individual layers are unbonded and allowed to flex freely. Each layer has its own substrate and cover.



Integrated solut.

Minco integrates temperature sensors and etched-foil heaters with flex circuits for unified temperature control.

Design Guidelines

Specification documents:

Consult standard specifications and design documents pertaining to your application and circuit requirements.

IPC specifications

www.ipc.org

- IPC-2221A, Generic Standard on Printed Board Design
- IPC-2223, Sectional Design Standard for Flexible Printed Boards
- IPC-4101, Specification for Base Materials for Rigid and Multilayer Printed Boards
- IPC-4202, Flexible Base Dielectrics for Use in Flexible Printed Circuitry
- IPC-4203, Adhesive Coated Dielectric Films for Use as Cover Sheets for Flexible Printed Circuitry and Flexible Adhesive Bonding Films
- IPC-4204 Flexible Metal-Clad Dielectrics for Use in Fabrication of Flexible Printed Circuitry
- IPC-6013, Qualification and Performance Specification for Flexible Printed Wiring
- IPC-MF-4562, Copper Foil for Printed Wiring Applications
- IPC Position Paper: Transitioning from MIL-P-50884C and MIL-PRF-31032 to IPC-6013 and Amendment 1



Military

www.dscc.dla.mil

- MIL-P-50884 (inactive for new designs), Printed Wiring, Flexible and Rigid-flex for Electronic Printed Wiring
- MIL-PRF-31032/3A, Printed Wiring Board, Flexible, Single and Double Layer, With or Without Plated Holes, With or Without Stiffeners, for Soldered Part Mounting
- MIL-PRF-31032/4A, Printed Wiring Board, Rigid-Flex or Flexible, Multilayer, with Plated Holes, with or Without Stiffeners, for Soldered Part Mounting

IPC recommends that companies using MIL-PRF-31032 specifications for printed circuits alternatively specify that flexible circuits be supplied under IPC-6013 Class 3 performance requirements. Government agencies have generally accepted that this is a COTS (Commercial, Off-The-Shelf) equivalent to MIL-PRF-31032. If your circuit must meet performance requirements of MIL-P-50884, MIL-PRF-31032 or IPC-6013; we urge you to read the IPC-2223 design specification for flexible circuits and follow its recommendations.

Minco documents

www.minco.com/

- Flex-Coils™ - Technical Specification FC01
- Minco/Omnetics Flex Circuit Interconnect Solutions Technical Specification FC04
- Designing for Flexibility and Reliability - Application Aid FAA31

Manufacturing a flex circuit

Building a flex circuit generally involves the same steps from circuit to circuit. However, certain circuit designs can add cost. The flow chart and illustrations identify some cost driven issues, such as access holes, plated through-holes, etc. The flow chart shows the manufacturing process for a standard double-layer circuit with a stiffener.

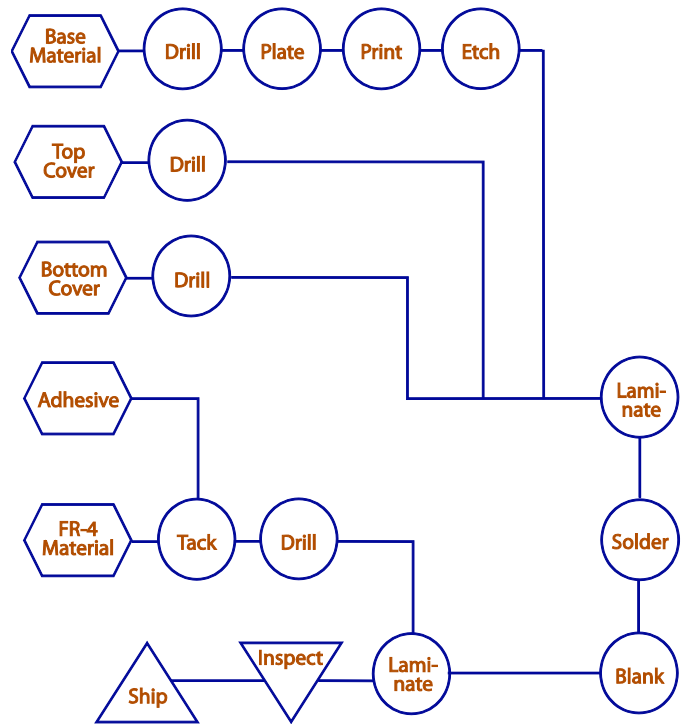
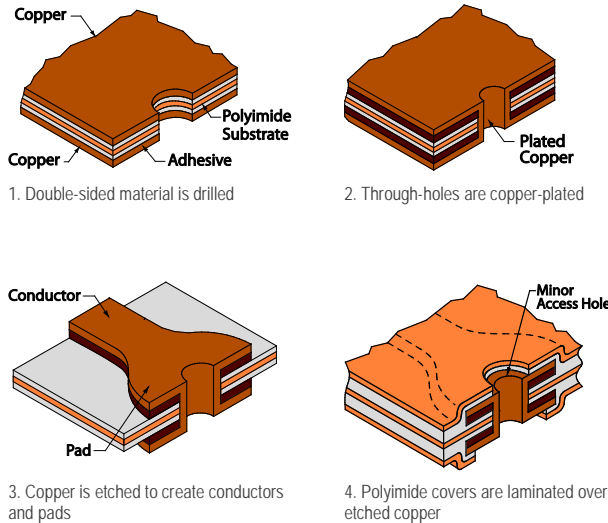

Cost impact of layer count

The information for the chart was taken from a sample of circuits built with Minco's standard materials. This chart is not intended to be used as a price guide. However, it does show that circuit cost generally rises with layer count.

It is in your best interest to consider all options to minimize cost. For example, use two circuits to do the job of one. Two double-layer circuits may be less expensive than one four-layer circuit. But the cost savings of the circuit may be offset by additional assembly requirements. Circuits can also be folded in order to save space and layers. Each situation is unique. A relatively small amount of time invested in project assessment can result in significant savings overall.

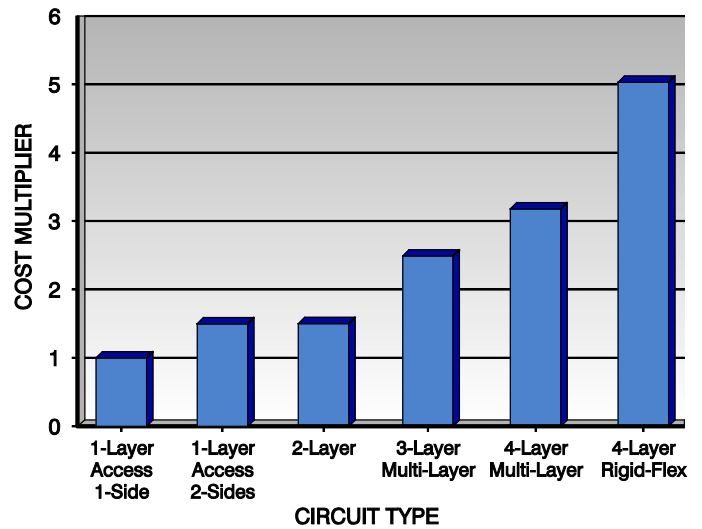

Circuit types

Single-layer

- IPC-6013, MIL-P-50884 - Type 1
- One conductive layer with an insulating layer generally on each side.

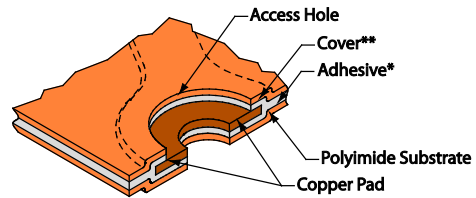

Double-layer

- IPC-6013, MIL-P-50884 - Type 2
- Two conductive layers with an insulating layer between them; outer layers may have covers or exposed pads.
- Plated through-holes provide connection between layers.
- Access holes or exposed pads without covers may be on either or both sides; vias can be covered on both sides.
- Stiffeners, pins, connectors, components are optional.

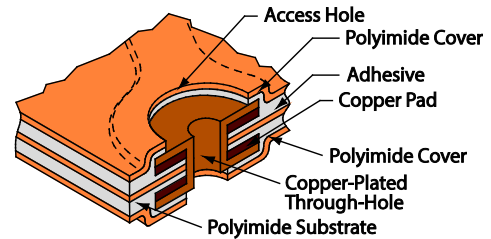

Multilayer

- IPC-6013, MIL-P-50884 - Type 3
- Three or more flexible conductive layers with flexible insulating layers between each one; outer layers may have covers or exposed pads.
- Plated through-holes provide connection between layers.
- Access holes or exposed pads without covers may be on either or both sides.
- Vias can be blind or buried.
- Stiffeners, pins, connectors, components are optional.

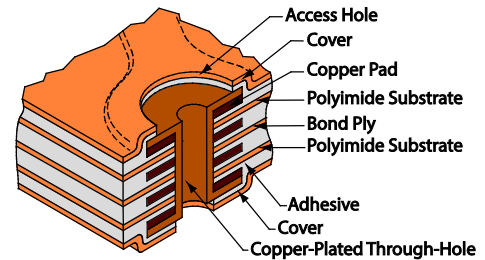

Multilayer, no plated through-holes

- IPC-6013, MIL-P-50884 - Type 5
- Two or more conductive layers with insulating layers between each one; outer layers may have covers or exposed pads.
- Through-holes are not plated.
- Access holes or exposed pads without covers may be on either or both sides.
- Stiffeners, pins, and connectors are optional.

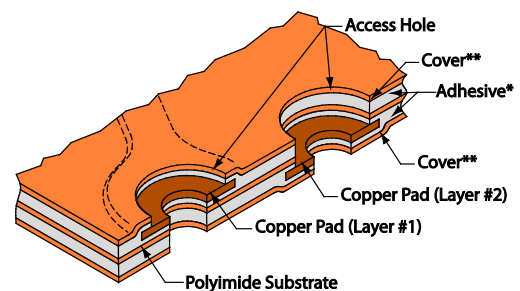

* Adhesiveless base material also available

**Cover may be replaced by liquid photoimageable coverlay (LPI)

Rigid-flex

- IPC-6013, MIL-P-50884 - Type 4
- Two or more conductive layers with either flexible or rigid insulation material as insulators between each one; outer layers may have covers or exposed pads.
- A Rigid-flex has conductors on the rigid layers, which differentiates it from multilayer circuits with stiffeners. Plated through-holes extend through both rigid and flexible layers (with the exception of blind and buried vias). Rigid-flex costs more than a standard circuit with stiffeners.
- Access holes or exposed pads without covers may be on either or both sides. Vias or interconnects can be fully covered for maximum insulation.
- Stiffeners, pins, connectors, components, heat sinks, and mounting brackets are optional.
- We also manufacture “flush” rigid-flex, where the top surface of contact areas is level with adjacent adhesive/insulation.
- Minco is capable of sequentially laminating, drilling, and plating circuits, which allows for more flexibility in designing the circuit.

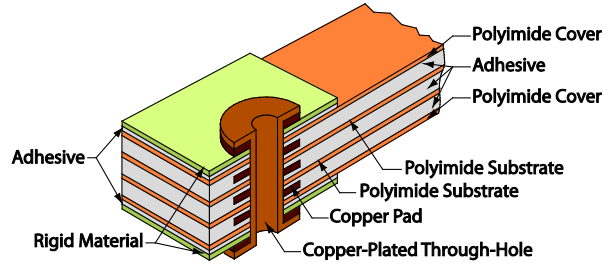

High Density Interconnect (HDI)

- IPC-6013, MIL-P-50884 - Type 3
- High Density Interconnect (HDI) flexible circuits offer increased design, layout and construction options over typical flexible circuits.
- High Density Interconnect designs incorporate microvias and fine features to achieve highly dense flex circuitry, smaller form factor and increased functionality.
- This technology offers better electrical performance, access to advanced integrated circuit (IC) package use and improved reliability through the use of microvias and thinner materials.
- Minco is capable of producing HDI products and designs. Specific HDI capabilities are represented throughout our various “Circuit Types” and “General Capabilities” sections of this design guide.

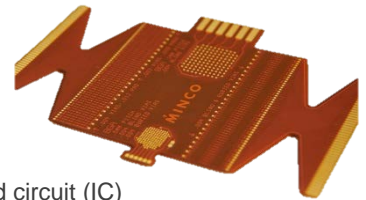

Flex-Coils™

Flex-Coils are flex circuits containing integral wire coils for use as antennas or inductors. There are three basic types of Flex-Coils:

- Simple, flat coils with wire leads
- Coils laminated inside flex circuits
- “Rim” coils that are built up in the Z-axis

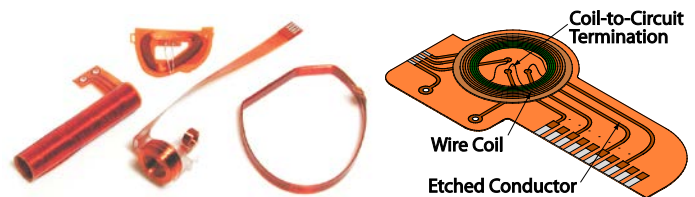

Flex-Coils™ have the same advantages that a flex circuit does. Wiring errors are reduced because the coil is oriented in the same spot every time, which provides repeatable signals. Flex-Coils™ are rugged and easy to assemble, and their design usually guarantees a reduced package size. A Flex-Coil™ can terminate in any manner that a flex circuit can, or to a wire lead. Heavy wire leads are available.

See Flex-Coils™ Technical Specification FC01, for more information on Flex-Coil™ capabilities, design considerations, and the information required for a quote or build.

Integrated solutions

Minco is a leading manufacturer of temperature sensors and Thermofoil™ flexible heaters. We have the unique ability to integrate these components and a flex circuit into a single package, drastically reducing assembly time and potential errors.

Minco's General Capabilities

Standard specifications

It is not possible to set design capabilities that apply to every specific situation, as exceptions will always exist. The following are capabilities that will apply in most cases.

Physical properties

Circuit size/standard panel size:

10.5 x 22" max./12 x 24" [267 x 559mm max./305 x 610mm], 16.5 x 22" max./18 x 24" [419 x 559mm max./457 x 610mm]

Layers: 20 for selected designs

Conductor width/space:

0.0015" (0.038mm) minimum / 0.0015" (0.038mm) minimum for thinnest foils

Hole diameter (plated): 0.002" (0.051mm) minimum.

Aspect ratio (ratio of hole depth/hole diameter):

12:1 maximum.

Outline dimensions and hole-to-border tolerance:

SRD: 0.015" (0.38mm) + 0.1% linear distance

CMD: 0.010" (0.25mm) + 0.1% linear distance

Laser/Hard tool:

0.003" (0.08mm) + 0.1% linear distance

Hole positional tolerance within a pattern: 002"

Hole positional tolerance pattern to pattern:

0.002" (0.05mm) + 0.2% linear distance

Bend radius (flexibility):

Double-layer: 12 x circuit thickness (minimum)

Multilayer: 24 x circuit thickness (minimum)

Circuit thickness is approximately 0.006" (0.15mm) per layer. Sharper, permanent bends are common for static bend-to-install applications of single layer circuits. Dynamic applications require special consideration.

Temperature: -65 to 150°C (-85 to 302°F)

Will withstand a 5-second solder immersion at 260°C (500°F) without blistering, delaminating, or discoloring. Extended exposure to temperatures over 105°C will result in some darkening of adhesive.

Chemical resistance:

No detrimental loss of physical properties when immersed for 15 minutes in acetone, methyl alcohol, toluene, or trichloroethylene.

Materials

Cover/substrate:

Polyimide film: ½ mil (12µm), 1 mil (25µm)*, 2 mil (50µm)*, 3 mil (75µm), 5 mil (125µm); Liquid Photoimageable Coverlay (LPI); Epoxy glass or polyimide glass (rigid-flex).

Conductor:

Copper: 1/8 oz. (5µm), 1/4 oz. (9µm), 1/3 oz. (12µm), 1/2 oz. (18µm)*, 1 oz. (35µm)*, 2 oz. (71µm), 3 oz. (107µm)

Cupronickel: 0.625 mil (15µm), 0.9 mil (22µm), 1.3 mil (33µm), 1.9 mil (48µm), 2.3 mil (58µm)

Nickel: 2 mil (50µm), 5 mil (125µm)

Adhesive:

Acrylic*, flame retardant, epoxy, epoxy prepreg, polyimide prepreg.

Stiffener:

Epoxy-glass (FR-4), polyimide-glass, polyimide, copper, aluminum.

** These are the most common materials used for manufacturing flex circuits for maximum flexibility.*

Surface finish (plating)

Plating methods:

Panel, selective (button plate), through-hole, blind via, buried via

Plating materials:

Solder, hard gold, soft gold, tin, nickel, silver, electroless nickel with immersion gold (ENIG), electroless nickel/palladium immersion gold (ENEPIG), organic solderability preservative (OSP)

Electrical characteristics

Insulation resistance:

100 MΩ minimum @ 25°C (77°F), assuming 0.010" (0.25mm) minimum conductor spacing.

Dielectric (typical):

1000 VRMS @ 60 Hz for 30 seconds, 1 mA maximum leakage current.

Shield layers:

Solid or grid patterns; copper foil or screened conductive ink.

Inductor/Antenna coils:

Specify inductance (10 mH to 30 mH, typical). Wire-wound coils may be integrated into the circuit. The cover encapsulates the coil, conductors, and coil connections.

Heaters/Temperature sensors:

Minco is a leading manufacturer of temperature sensors and Thermofoil™ flexible heaters. We have the unique ability to integrate these components and a flex circuit into a single package, drastically reducing assembly time and potential errors. Call Minco to discuss your application, or visit www.minco.com.

Value added assemblies**

Connectors:

Clincher:

0.100" (2.54mm) minimum, center-to-center;

Micro series:

0.050" (1.27mm) minimum, center-to-center;

Nano series:

0.025" (0.63mm) minimum, center-to-center.

Optional epoxy potting is available.

Fingers:

Supported:

0.006" (0.15mm) minimum, center-to-center;

Unsupported:

0.020" (0.50mm) minimum, center-to-center.

In-line or right angle.

Pins:

Swaged/soldered:

0.085" (2.15mm) min., center-to-center;

0.100" (2.54mm) typical;

Brazed:

0.035" (0.89mm) min., center-to-center.

Active Components:

Pick-and-place, Hand solder or braze

Surface mount, through-hole, embedded

***See pages 22-23 (Value Added Design Options) for more information on incorporating these assemblies into your design.*

Quality management

Minco is certified to ISO 9001: 2008 | AS9100:2009 (Rev. C) | EN9100 | SJCA9100 | Nadcap: Electronics AC7119 and AC7117/2 quality system requirements

All specifications subject to change.

Testing

When specifying testing, consider your needs carefully. Over specification can greatly increase circuit cost. Minco encourages electrical testing. It is required on all multilayer, rigid-flex, and factory-formed circuits that are fabricated to MIL-P 50884, and certain classes of IPC-6013.

Minco can test for...	Range of operation
IPC-6013	N.A.
Complete dimensions	Resolution: 4 decimal places Accuracy: 0.001" (0.025mm) + 0.008% of linear distance
Dielectric withstanding	Up to 6000 V
Electrical continuity	1 Ω to 10 k Ω ; suggest 5 Ω Stimulus: 0.01 V to 5.0 V
Ionic cleanliness	.5 microgram/square cm NACL equivalent
Insulation resistance	10 k Ω to 100 M Ω at 10 VDC to 250 VDC Suggest 100 M Ω at 100 VDC
Thermal shock	-70 to 200°C
Moisture resistance	Up to 98% relative humidity
Plating thickness	Down to 0.000001" (0.02 μ m)
Flexibility	0 to 999,999 flexes
Microsections	Viewed at up to 1000x

Marking

Minco can meet your marking requirements.

Our legend marking system offers silkscreen-like printing using a durable white ink that meets IPC-TM-650 industry standards. This system allows us to incorporate date code and serial numbering, along with panel based marking, at the same time.

We can also offer traditional epoxy ink hand stamp or silkscreen printing if an alternate color or legacy specification is required.

Etched marking within the part is also an option. Stiffeners and covers may be marked with component mounting locations.

Control impedance and electrical noise

Predictable electrical characteristics make flex circuits an ideal choice for high-speed signal transmission. Uniform spacing between conductors and grounds, continuous shield layers, and repeatable geometries are features that help control impedance and reduce crosstalk. And with flex circuits, you can eliminate connectors and other transitions that contribute to signal attenuation.

Minco can provide tight tolerances on line width, spacing, and distance to ground layers in order to meet your impedance requirements. Actual impedance will also depend on the circuit's shape after installation.

- Microstrip - a single ground plane beneath the signal lines.



- Stripline - dual ground layers above and below the signal lines.

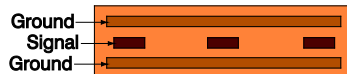

- Edge coupled differential pairs – traces are adjacent to each other in the same plane with tightly controlled width and spacing - ground plane optional.



- Rigid-flex/stiffened flex circuits with uninterrupted ground layers.
- Silver epoxy coating – Conductive silver epoxy is applied to the outside of circuits and electrically connected to other layers via access holes in the cover coat. Silver epoxy shielding is more flexible than copper.

Contact Minco for advice on designing circuits to specific electrical characteristics.

Conductor width nomograph

The nomograph on the facing page will help you determine the maximum allowable current capacity (in amperes) of a conductor. Reprinted from IPC-222, the nomograph shows current for various conductor thicknesses, width, and temperature rises.

Using the nomograph

1. Locate the width of the conductor on the left side of the bottom chart.
2. Move right horizontally, until you intersect the line of the appropriate conductor thickness. Move down vertically to the bottom of the chart to determine the cross-sectional area of the conductor.
3. Move up vertically, until you intersect the line of the appropriate allowable temperature rise. This is the increase in temperature of the current-carrying conductor. Conductor temperature should not

exceed 105°C. For example, if the ambient temperature might reach 80°C, the temperature rise above ambient of the conductor should be less than 25°C (105°C - 80°C). In this case use the 20°C curve.

4. Move left horizontally to the left side of the chart to determine the maximum allowable current.
5. Reverse the order of these steps to calculate required conductor width for a given current.

Conductor aspect ratio

For best manufacturability, design conductors to be at least five times as wide as they are thick. For example, with 2 oz. Copper (0.0028"/50µm) design the conductors to be 0.0140" (0.36mm) or wider. In tight situations Minco is successful in achieving 2.5:1 ratio conductor widths.

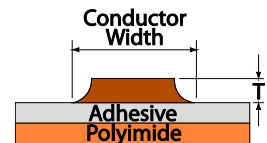

Assumptions

1. The nomograph is valid only for conductors with a polyimide cover layer — not exposed conductors.
2. The conductor thickness includes copper plating. Be aware that plating may add 0.0005" (13µm) to 0.0014" (36µm) of thickness. Selectively plated circuits do not have significant plating over conductors. The nomograph does not apply for plated metals other than copper.
3. De-rate current by 15% for conductor thicknesses greater than 3 oz. (0.0042"/75µm).
4. The temperature rise curves only recognize heat generated by the conductor itself. Heat from power dissipating components or nearby conductors on other layers is not included.
5. It is assumed that conductor coverage is relatively small; i.e. there is enough free space between conductors for lateral heat dissipation. Groups of closely spaced parallel conductors on the same layer can be treated as one large conductor.
6. Add all of the cross sectional areas together and all the currents together to determine the temperature rise.
7. Current ratings are for still-air environments. Forced air cooling will increase the maximum allowable current. Operating circuits in a vacuum will greatly decrease the maximum allowable current.

Contact Minco for assistance in cases where the nomograph does not apply or if you have difficulty designing sufficient current capacity into the space available. We can suggest ideas to increase current capacity.

Conductor width nomograph

Example #1: A current of 1 amp with ½ oz. copper and 30°C temperature rise will require a conductor width of 0.040".

Example #2: A 0.140" wide conductor etched from 1 oz. copper (0.0014") will produce a temperature rise of 10°C at 2.7 amp.

Wire Gauge Equivalent (AWG)

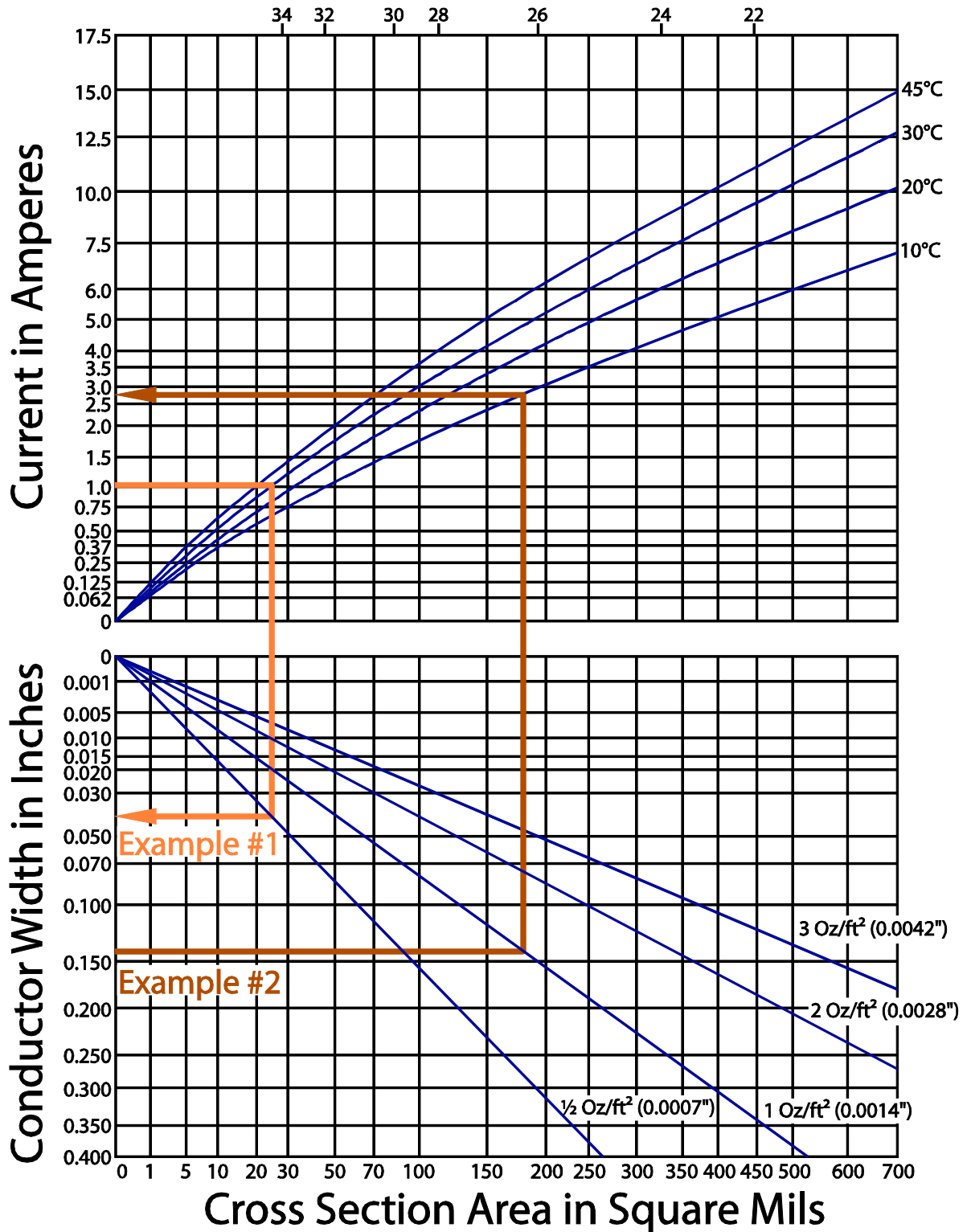

Standard Design Recommendations

Design differences and special considerations

Define circuit parameters by application

It may be helpful to use a paper template to represent the circuit. Experiment with bending and forming the template to optimize shape and fit. When designing the final shape, consider how the circuits will lay out on a processing panel (“nesting”). The greater the number of circuits per panel, the lower the cost.

Another consideration concerns rigid-flex. While Minco is capable of building a traditional rigid-flex board for you, it may not be your best choice. Multilayer or stiffened flex boards may be able to meet your requirements for component and board mounting at reduced cost.

Flex circuit vs. hardboards

Designing a flex circuit is only one step away from designing a hardboard. The most important design difference to keep in mind is the three-dimensionality of a flex circuit. Creative bending and flexing can save space and layers. Other important differences:

- Flex circuits both require and permit looser tolerances than hardboards.
- Because arms can flex, design them slightly longer than required.

Design tips to minimize circuit cost

- Consider how circuits will be “nested” on a panel.

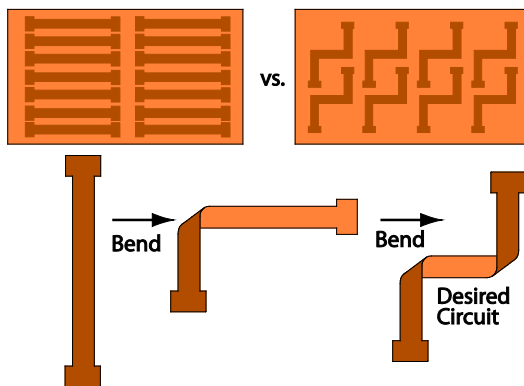

- Keep circuits small; consider using a set of smaller circuits instead of one large circuit.
- Follow recommended tolerances whenever possible.
- Design unbonded areas only where they are absolutely necessary.
- If circuits have only a few layers, using stiffeners can be far less expensive than a rigid-flex circuit.

Special considerations for rigid-flex

- Rigid-flex is the ideal solution for applications with multiple rigid PCBs having SMT components on both sides and requiring interconnects between the rigid PCBs.
- Before designing a rigid-flex circuit, make certain that it is truly what you need. If the circuit only has a few layers, stiffeners are a less expensive alternative to rigid-flex.
- It is most cost effective to build a rigid-flex with an even number of layers. All rigid portions of the circuit should have the same number and stack-up of layers.
- Observe aspect ratio (hole depth/hole diameter) limits.
- Minco builds circuits up to 20 layers, but costs increase significantly above 10 layers.
- Expect a trim tolerance similar to that of a steel rule die from hole-to-border and border-to-border.
- Hole positional tolerance within a cluster of holes is generally $\pm .003$ ". Add $.002$ " per inch for tolerances between cluster datums, especially those in different rigid areas.
- Minimum inside corner radius of 0.031 " (0.79mm) is standard, but smaller radii are possible.
- Unbonded layers can increase flexibility in multilayer flex circuits, but this option is more expensive. Specify unbonded layers only in areas of the circuit that will bend.
- Minco can provide an epoxy fillet on stiffener edges that will bend or flex.
- For rigid-flex circuits, it is less expensive to have plated through-holes in the rigid portions only.
- Minco can provide blind and buried vias in rigid-flex circuits.

How to improve flexibility and bend radius

Two or more layer circuits are best suited to static applications, which flexes only during installation.

Several problems can arise when a circuit is bent sharply. Compression can cause wrinkles in the cover coat on the inside of the bend. Stretching can result in tears in the cover material and/or broken conductors on the outside of the bend.

Start the mechanical design by establishing the bend radius. If the radius is at least ten times the thickness of the material, there is a good chance that the circuit will function reliably.

The minimum allowable bend radius depends on a number of factors, and is best defined by IPC-2223. Overall circuit thickness is slightly less than the sum of the individual insulator, adhesive and foils layer thicknesses.

Bend radius (flexibility):

Double-layer: 12 x circuit thickness (minimum)
 Multilayer: 24 x circuit thickness (minimum)
 Circuit thickness is approximately 0.006" (0.150mm) per layer.

Incorporate these features into multilayer and reduced bend ratio designs to increase reliability

1. Reduce overall thickness in the flex area

- Reduce the base copper weight (and the corresponding adhesive thicknesses) or reduce the dielectric thickness.
- Use adhesiveless base materials. Adhesiveless materials will usually reduce the starting thickness of each substrate by 1-2 mils (25-50µm) when compared to adhesive based substrates.
- Eliminate copper plating on the conductors in the flex area by utilizing selective (pads-only) plating or adding outer pads-only layers to the circuit.

2. Make the circuit robust to withstand flexing

- Balance the conductor weights and material thicknesses on each side of the neutral bend axis.
- To increase flexibility, conductors should be staggered from layer to layer and not stacked on top of each other.

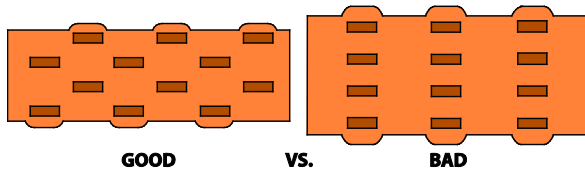

- Conductors should always be routed as close to perpendicular as possible through bend areas.
- Conductor thickness and width should remain constant in bend areas.
- Add stiffeners under termination areas to remove the stresses around the terminations. Consider strain relief at the edges of the stiffeners.
- Plated through-holes should be kept out of the bend areas.
- If the circuit will be bent within 1" (25.4mm) of termination pads, fillets should be placed at each conductor/pad interface. Stresses from a bend are not isolated to the immediate bend area and residual stresses can radiate out from the bend.
- If shields and/or ground planes are required on the circuit, use a cross-hatched pattern rather than solid copper. Another shielding option is a screened-on conductive coating such as silver epoxy, which is much more flexible than copper.

- Incorporate tear stops or reliefs for slits in the circuit. The end of the slit represents a vulnerable point for a tear to start and to propagate.
- Avoid any discontinuities in the cover coat or substrate near a bend.
- The circuit outline should be designed so there are no twists in the finished assembly. Any burr or irregularity from the blanking operation could potentially propagate into a tear.
- Consider factory forming. Reliable bend radii tighter than 10:1 are possible if the circuit is formed using specialized tooling and will only be flexed one time.
- If bend reliability is still a concern, consider "unbonding" the flexible substrates from each other. Since each of the substrates in the unbonded area has a much lower thickness than the total circuit, they are able to bend tighter than if they were fully bonded.

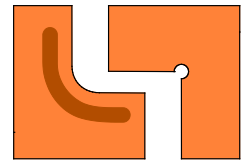

For a more in-depth look at this subject please see *Designing for Flexibility and Reliability Application Aid FAA31* – www.minco.com

Holes

Preferred minimum design requirements for pad and access hole sizing for IPC class 3 circuits*

Feature	Design pad size	Design Cover size
Type 1+5 circuits	0.024" (0.61mm) + T	0.030" (0.76mm) + t
Outside pads-Types 2-4	0.018" (0.48mm) + T	0.022" (0.56mm) + t
Interior pads-Types 2-4	0.014" (0.36mm) + T	NA

t = nominal through-hole diameter.

* Pad and major access hole design requirements are based on typical IPC annular ring requirements of 0.002" (0.05mm) minimum for all external layers for types 2-4, and 0.001" (0.025mm) minimum for multilayer inner layers.

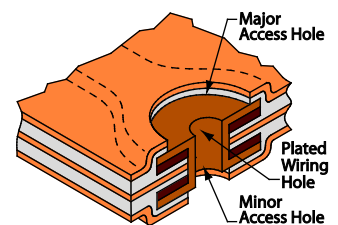
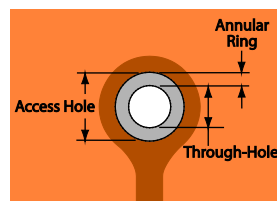

Vias

Minco can provide circuits with covers that have no access holes exposing the vias (called "tented vias"). Minco can also provide blind and buried vias in multilayer and rigid-flex circuits. Blind vias connect the top or bottom conductor layer to adjoining layers, but the via does not extend through all layers. A buried via only connects internal layers and is not exposed in the finished circuit. Blind and buried vias increase circuit cost, but they free up space for additional conductors on the non-drilled layers. We can also planerize blind vias in surface mount pads for additional space savings.

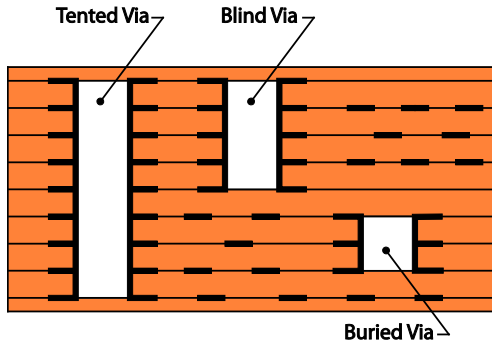

Through-hole (Thruhole)

Plated through-holes (PTH) connect together the top, bottom, and any required internal conductor layers. PTHs are drilled oversize to accommodate the thickness of the copper plating that will cover the entire barrel of the hole as well as the surface of the outer pads. Exterior pads may be plated along with the entire foil surface or selectively plated just at the PTH site.

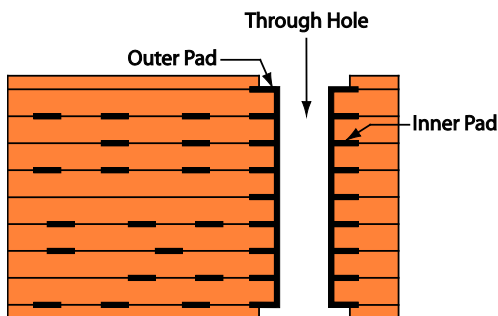

Stiffener holes:

Stiffener holes should be a minimum of 0.015" (0.38mm) in diameter larger than the access hole. It is better if the access hole underneath the stiffener hole is a minor access hole in order to increase the stiffener web between holes and to prevent potential solder wicking between the stiffener and the circuit. The customer must allow tangency. Round stiffener holes are less expensive than slotted stiffener holes, and thinner stiffener material (less than 0.031"/0.79mm) is less expensive to process.

Wiring holes

Minco can drill through-holes as small as 0.0039" (0.10mm). A 0.020" (0.50mm) through-hole size is typical. Standard finished hole tolerance is ± 0.003 " (0.08mm). For all circuits, the finished through-hole size should be 0.003" (0.08mm) to 0.010" (0.25mm) larger in diameter than the component lead. This depends on the number of leads per component, and the positional tolerance of the component leads.

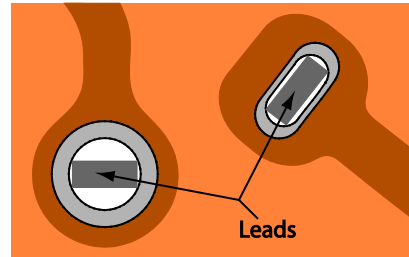

Round (instead of slotted) through-holes are preferred. This will reduce drilling time and cost.

Pads

Whenever possible, design pads larger than the access holes as this allows for a more rugged connection. If space is critical, use hold-down tabs. A variety of hold-down tab designs are available.

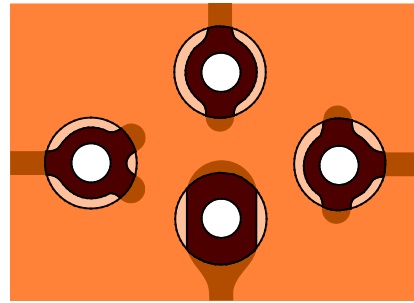

Pad fillets

Pad fillets improve etched yield and material strength. Fillets are appropriate when the pad diameter is greater than the connecting strand width. Acute angles at the interface between conductors and pads are to be avoided by using fillets to minimize the concentration of stress at the interface.

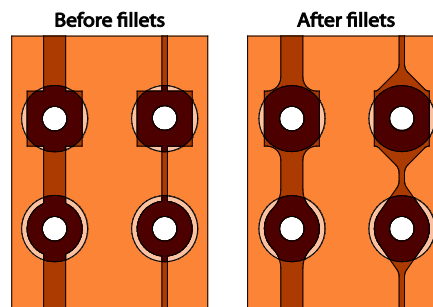

Surface mount access

Minco can provide flex circuits with areas that are specifically designed for surface mount components. Because covers are drilled (not silk-screened), round access holes are easier to provide. Square access holes will add to cost because the pad access area would have to be punched out with a punch-and-die. Square pads with round access holes are a good compromise. Below are some ideas for configuring pads for surface mount.

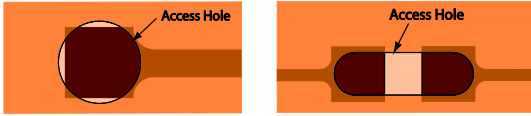

Liquid Photo Imageable coverlay materials are also available, and can provide intricate, irregular shaped openings for dense surface mount patterns.

Soldering tips

- Since polyimide absorbs moisture, circuits must be baked (1 hour @ 120°C minimum) before soldering.
- Pads located in large conductor areas, such as ground planes, voltage planes, or heat sinks, should be provided with relief areas, as illustrated. This limits heat dissipation for easier soldering.
- When hand soldering pins in dense clusters, avoid soldering adjacent pins one after another. Move around to avoid local overheating.
- Minco can solder connectors or components (SMT or Through-hole) as an added service.
- Minco can supply circuits in panel form for easier component assembly.



Thermal relief

Tolerances

You are not limited to the tolerances listed in this section. Tighter tolerances are achievable, but often at a higher cost. Accordingly, more relaxed tolerances will typically cost less. Even with relaxed tolerances, a flex circuit will have a uniformity that is impossible to attain with conventional wiring. The flexibility of materials within a flex circuit construction allow it to be more compliant than rigid circuits, so it is not always necessary to specify tight tolerances across all dimensions.

Trimming

Each trimming method has advantages and disadvantages. Routing and laser trimming provide hard tooling (punch and die) tolerances for small quantities of circuits. Laser trimming is also capable of creating complex cutouts not feasible with other methods. Steel rule dies (SRD) are best for intermediate quantities and tolerances. Chemical milled dies (CMD) offer tighter tolerances than SRDs for an incremental increase in cost. Hard tooling (punch and die) is recommended for tight tolerances, complex circuits, and/or high quantity. For more specific information on SRD, CMD, and punch-and-dies, see the Glossary at the end of this guide.

Circuit dimension in inches(mm)†	Outline dimensions (profile tolerance)			Hole-to-border dimensions			Cluster to cluster§
	SRD	CMD	Punch and die /laser	SRD	CMD	Punch and die /laser	
1	±0.015 (0.38)	±0.010 (0.25)	±0.003 (0.08)	±0.015 (0.38)	±0.010 (0.25)	±0.007 (0.18)	±0.003 (0.08)
5	±0.020 (0.50)	±0.015 (0.38)	±0.007 (0.18)	±0.020 (0.50)	±0.015 (0.38)	±0.012 (0.30)	±0.007 (0.18)
10	±0.025 (0.63)	±0.020 (0.50)	±0.012 (0.30)	±0.025 (0.63)	±0.020 (0.50)	±0.017 (0.43)	±0.012 (0.30)
15	±0.030 (0.76)	±0.025 (0.63)	±0.017 (0.43)	±0.030 (0.76)	±0.025 (0.63)	±0.022 (0.55)	±0.017 (0.43)
20	±0.035 (0.88)	±0.030 (0.76)	±0.022 (0.55)	±0.035 (0.88)	±0.030 (0.76)	±0.027 (0.69)	±0.022 (0.55)

† Round up circuit dimension to next highest increment.

§ Represents from a group of holes to a group of holes. Holes within a group will have a tolerance of ±0.003" (0.08mm).

Note: Dimensional tolerances are given in inches. See Glossary for definition of profile tolerance.

Solder thickness

Minco follows IPC-6013 requirements of coverage and solderability for solder coatings.

Conductor width, thickness, and spacing

Minco can provide a 0.004" (0.10mm) minimum conductor width/spacing (0.0025"/0.063mm minimum at higher cost) on 1 oz. (25µm) copper and 0.005" (0.13mm) minimum conductor width/spacing on 2 oz. (50µm) copper (for thicker copper, consult Minco). For best producibility, design circuit conductors at least five times wider than they are thick.

Tolerances for conductor width depend on whether the copper is plated or unplated.

Copper thickness	Plated copper	Unplated copper
½ oz.	±0.001" (25µm)	±0.0005" (25µm)
1 oz.	±0.002" (50µm)	±0.001" (25µm)
2 oz.	±0.003" (75µm)	±0.002" (50µm)
3 oz.	±0.004" (100µm)	±0.003" (75µm)

Materials

This table lists the materials and material thicknesses that Minco has available. Minco's standard materials are in **boldface**. If the material or thickness is not listed, consult Minco at 763.571.3121.

Material function	Material type	Sizes/thickness available
Flexible insulator	Kapton* and other polyimide films †	1/2 mil (12.5µm), 1 mil (25µm), 2 mil (50µm), 3 mil (75µm), 5 mil (125µm)
Rigid substrate (rigid-flex)	FR-4	Variety of thicknesses between 0.003" (0.08mm) and 0.125" (3.18mm)
	Polyimide	Variety of thicknesses between 0.003" (0.08mm) and 0.125" (3.18mm)
Conductor	Copper	1/4 oz. (9µm), 1/3 oz. (12µm), 1/2 oz. (18µm), 1 oz. (35µm), 2 oz. (71µm), 3 oz. (107µm), 5 oz. (175µm), 7 oz. (254µm), 10 oz. (356µm)
	Different forms of copper	Half-hard, rolled-annealed, electro-deposited
	Beryllium copper	3 mil (75µm): half-hard and quarter-hard 4 mil (100µm): half-hard
	Cupro-nickel (70/30 alloy)	0.625 mil (15µm), 0.9 mil (22µm), 1.3 mil (33µm), 1.9 mil (48µm), 2.3 mil (58µm)
	Nickel	2 mil (50µm), 3 mil (75µm), 5 mil (125µm)
	Silver epoxy	‡ coverage about .001" thick
Adhesive §	Modified acrylic	1/2 mil (12.5µm), 1 mil (25µm), 2 mil (50µm), 3 mil (75µm), 4 mil (100µm)
	Modified acrylic – flame retardant	1/2 mil (12.5µm), 1 mil (25µm), 2 mil (50µm), 3 mil (75µm), 4 mil (100µm)
	Pressure-sensitive adhesive (PSA)	1 mil (25µm), 2 mil (50µm), 5 mil (125µm)
	Pre-impregnated material: FR-4, polyimide	2 mil (50µm), 8 mil (200µm)
Stiffener	Copper, Aluminum, and other metals	Variety of thicknesses available
	Polyimide glass	See "Rigid substrate/Polyimide glass" above
	FR-4	Variety of thicknesses between 0.005" (0.13mm) and 0.125" (3.18mm)
	Polyimide	1/2 mil (12.5µm), 1 mil (25µm), 2 mil (50µm), 3 mil (75µm), 5 mil (125µm)

* Kapton is a registered trademark of DuPont for polyimide. Dielectric strength of plain Kapton film is 3500-7000 volts/mil (0.025mm) depending upon material thickness. Kapton/modified acrylic has a dielectric strength of 3500 volts/mil (0.025mm) and a temperature rating of -65 to 150°C, although circuits will discolor after long-term exposure at 150°C. For special applications, Minco can use an adhesive that will withstand temperatures of 150°C continuous, and 200°C short-term.

† Other polyimide films are available for special applications.

‡ Material is applied as an alternative to standard copper layers.

§ In general, Minco recommends 0.001" (25µm) of adhesive on the cover material per 1 oz. (35µm) of copper (including plated copper). There may be special circumstances where more is required. Consult Minco for details.

Value Added Design Options

Terminations

There are a variety of terminations for a flex circuit, and a variety of methods for applying these terminations.

Connectors

Connectors are usually customer selected, but Minco can recommend certain types of connectors to meet specific application requirements. Connectors can be attached to flex circuits by hand soldering, wave soldering, crimping, or simple insertion with zero insertion force (ZIF) models. Connectors can be potted after attachment or conformal coated for protection and insulation with epoxy, polyurethane, or RTV.

One good option for many low cost applications is the Clincher™ insulation displacement connector.

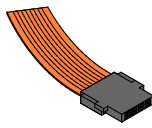

High density connectors, with 0.050" (1.27mm) or 0.025" (0.63mm) center-to-center terminals are available from Omnetics Connector Corporation in several forms, including high temperature and MIL-spec options.



Vertical or Horizontal mounting to fit your designs.



Up to 44 Beryllium Copper pins in less than half the space of an 0.050"(1.27mm) connector!



Mil-spec connectors with temperature ratings to 200°C.



Round form connectors for surface mount installation.

Connector type	Centerline distance
Clincher connector	0.100" (2.54mm) min.
Micro series pin center-to-center	0.050" (1.27mm) min.
Nano series pin center-to-center	0.025" (0.63mm) min.

Fingers

Fingers can be supported or unsupported. Supported fingers are ideal for ZIF connectors mounted on rigid boards. Unsupported fingers can be hot bar soldered to hard circuit boards.

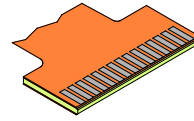

Supported fingers

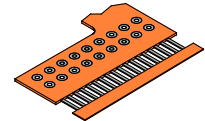

Unsupported fingers

Finger type	Centerline distance
Supported	0.006" (0.15mm) min.
Unsupported	0.020" (0.51mm) min.

Pins

- Socket pins are pressed in place and then soldered. Pins can be swaged to the circuit and soldered after the swaging procedure, or pins can be swaged to an FR-4 stiffener and then soldered. Swaged/soldered pins are moderately priced and have good mechanical strength.
- End pins that are in line with conductors can be brazed, soldered, or crimped to conductors. Pins can be bent to form a staggered arrangement.
- Flex circuits can interface to hardboards via soldered lap joints, or lap joints applied with an anisotropic adhesive (conductive in the Z-axis only).

Pin type	Centerline distance
Swaged	0.100" (2.54mm) typical, 0.085" (2.15mm) min.
Brazed	0.100" (2.54mm) typical, 0.035" (0.89mm) min.

Pins can be inserted separately or ganged in a header. Minco recommends using an FR-4 or polyimide stiffener in pin areas to improve mechanical strength and simplify assembly.

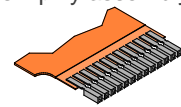

Crimped sockets and pins

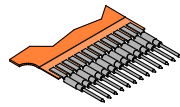

Swaged or nailhead pins with stiffener

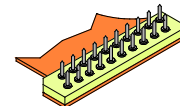

End pins

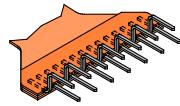

Lap joint

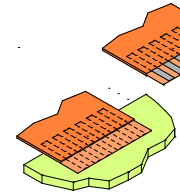

Stiffeners

Benefits of using a stiffener

- Stiffeners are an inexpensive option for rigidizing pin areas, surface mount areas, or hole patterns for component mounting (provided SMT components are on one side only). Surface mount areas do not always require a stiffener, depending on component size, but a stiffener is recommended and will add very little to cost or bulk.
- Stiffeners can be utilized to force a bend line in selected areas. Minco can provide epoxy fillets for the edges of the FR-4 stiffener, where flexing occurs.
- Stiffeners reinforce solder joints and increase abrasion resistance.
- Circuits may be attached to a stiffener pallet (multiple parts) to provide easier handling for automated pick-and-place and component soldering. Circuits can be held together for processing on the pallet, then singulated (clipped free) after wave soldering and circuit testing.
- Stiffeners can be marked with component mounting locations for rapid assembly.
- Stiffeners are commonly FR-4 or polyimide material. They are usually applied with modified acrylic adhesive.
- Standard FR-4 material thicknesses range from 0.003" (0.08mm) to 0.125" (3.18mm). Typical thickness for polyimide stiffeners is 0.005" (125 μ m), but 0.001" (25 μ m), 0.002" (50 μ m), and 0.003" (75 μ m) are also available. Polyimide stiffeners are less expensive than FR-4 stiffeners because they are punched on a die instead of routed with a drill bit. The polyimide stiffener lay-up procedure is performed with alignment pins, therefore, registration is better. The polyimide stiffeners are trimmed with the cover on the final blanking procedure, which guarantees perfect outside alignment.
- When using multiple stiffeners, maintaining the same stiffener thickness consistent throughout the entire construction can help lower costs.

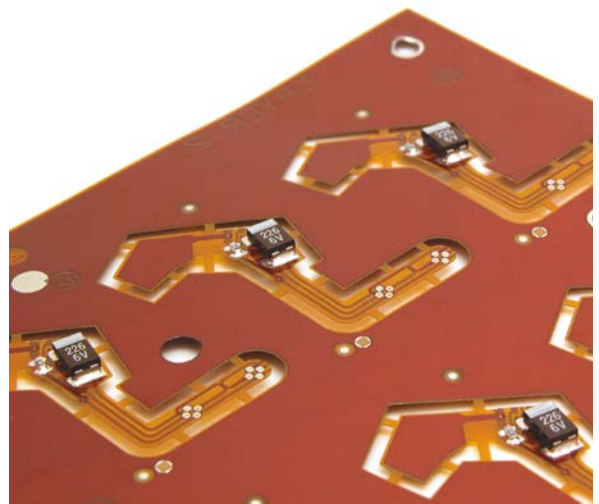
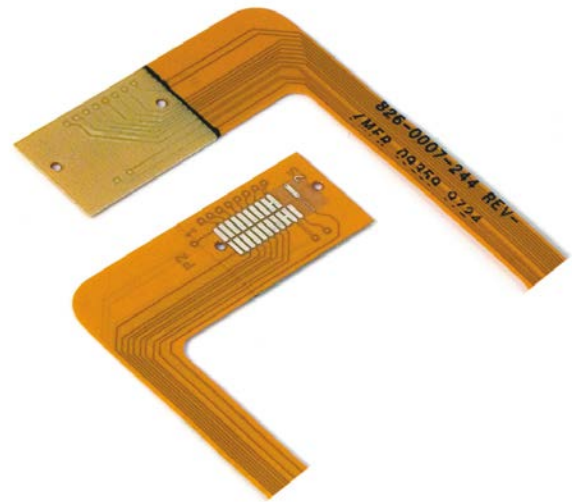
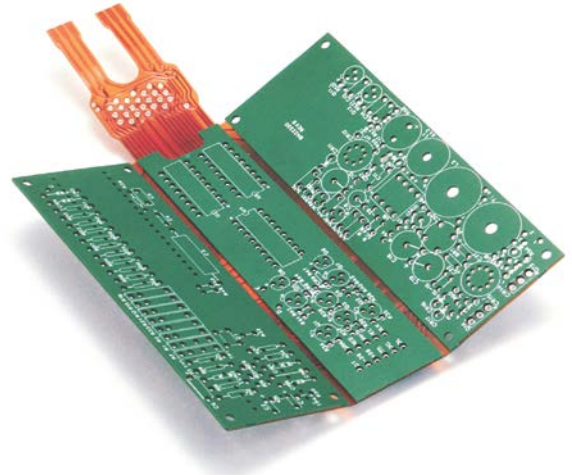

Forming

Flexible materials don't guarantee that the circuit will function reliably when bent or flexed. There are many factors that contribute to the reliability of a printed flex circuit and all of these factors must be taken into account during the design process to ensure that the finished circuit will function reliably.

When designing a flex circuit, the designer must factor in all of the parameters that will have an impact on the circuit's ability to bend or flex in the specific application. These include, but are not limited to: whether the application is static or dynamic, bend radii, dielectric thicknesses and type, foil weight, copper plating, overall circuit thickness, number of layers, and number of flex cycles.

The tighter a bend radius becomes, the higher the probability of failure during flexing. Keeping the overall thickness of the flex circuit in a bend area to its minimum will increase reliability. The ratio of bend radius to thickness is one indicator of whether the design is going to be reliable or have a high probability of failure. If the bend radius is at least ten times the thickness of the material, there is a good chance that the circuit will function reliably. If the calculated bend radius falls below ten to one, the design may be questionable. Formulas for calculating the minimum allowable bend radius for several circuit types can be found in IPC-2223.

It is possible to design for much tighter bend radii in a bend-to-install application which retains the formed shape of the circuit. The circuit must be designed to withstand stretching along the outer bend and compression of materials on the inner bend. Stretching can tear covers or crack conductors, while compression causes foil and cover wrinkling that can also lead to tears. These problems become more of a concern in applications that require the circuit to be bent beyond a 90-degree angle. As the bend angle increases beyond 90 degrees, the damaging effects of stretching and compressing increase dramatically. Any time that a reduced radii bend beyond 90 degrees is incorporated into a circuit design, the circuit should be bent one time only. On bends over 90 degrees, it is also advisable to constrain the circuit in the formed condition to keep it from relaxing or being inadvertently reopened.

The ideal circuit design would have no copper plating on the conductors in the forming or flexing area. Electrolytic copper has much lower ductility than that of

rolled annealed copper, making it much more susceptible to fracturing when it is bent or flexed. Other types of plating, such as gold and/or nickel, should be avoided in the flexing area for the same reasons.

Copper plating on the flexing conductors may be eliminated by using pads-only plating or designing with pads-only layers on the external surfaces.

Minco can factory form some flex circuits with radii all the way down to a "crease" (dependent upon board design) to improve installation precision and repeatability within our customer's assembly process.

When designing a part for forming, it is important to avoid mechanical stressors in the bend zone. Stressors include pads, holes, components, and sharply angled conductors. These reflect the most common features problematic to forming.

Forming imparts stress into circuits. Some designs will be better suited to this forming process than others. Minco encourages customers to discuss with our engineers, the intended usage of parts they want formed, to help determine suitability.

Forms are likely to relax slightly over time. Tight tolerance forms are typically not held by flex circuits. Minco recommends specifications to read "reference only" or to describe the parts as "capable of attaining 'x' dimensions" for both angular and linear aspects of forming.

Formed parts are less capable of withstanding temperature variations than their un-formed counterparts. This is particularly true where the bend zones are exposed to solder reflow or high temperature sterilization procedures. To work around these limitations, Minco can suggest optional designs or assembly processes. Please contact us to discuss your needs.

Population

Minco can assemble hardware and electronic components onto your flex and rigid-flex circuits.

Numerous connectors are available for flex termination, ranging from crimp connectors to nano-size SMT connectors or discrete pins.

Heat-sinks, metal stiffeners, and plastic mounting frames may also be laminated, heat staked or glued to flex circuits.

Flex-coil designs are an example of an embedded component supplied within flex, multilayer, and rigid-flex circuits.

The most common electronic components are typically surface mounted to the flex circuit using automated pick-and-place equipment. Design considerations for populating flex circuits differ slightly from rigid boards. Simple flex circuits usually need to be stiffened for surface mount components. Our design engineers will make recommendations for necessary design factors to meet your needs.

Between our in-house capabilities and our vendor network we're able to offer our customers bare parts, palletized and unpopulated, partially populated or fully populated circuits.

Custom and Integrated Components

Minco operates four different product lines, all coordinated in the same facility for faster, seamless integration that can boost your time-to-market. This makes us unique in our ability to customize and integrate components into turnkey assemblies and complete thermal, sensing and flex circuitry solutions. All of our components can be designed, manufactured, and integrated to perfectly fit your application while providing matched system accuracy.

Custom Solutions

Minco's customized products provide an affordable solution to meet your exact specifications. We work diligently to build our products with the greatest efficiency, quality, and accuracy to meet your critical standards and ensure ROI.

Minco can customize all of our products to perfectly fit your application.

Thermofoil™ Heaters

- Irregular shapes, size and holes for a precise fit
- Single or dual element for critical redundancy and rapid heat transfer
- Profiled and multi-zone heaters to put the heat exactly where you need it
- Leadwire, flex circuit or solder pad terminations for easy integration into your assembly

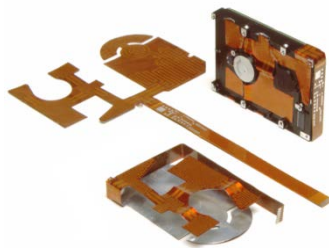

Sensors and Instruments

- RTD and thermistor elements to match any TCR (temperature coefficient of resistance) curve
- A variety a materials and machining options available to provide critical thermal response in your application
- Leadwire and cable options to meet your application parameters
- Custom transmitters, controllers, and monitors for accurate sensing packages

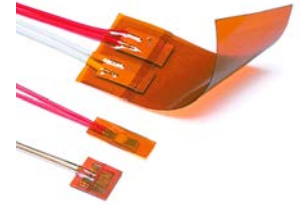

Flex Circuits

- Single-layer, double-layer, multilayer and rigid-flex circuits with high layer counts to meet your interconnection needs
- Fine lines, circuit forming and selective bonding add to space and weight savings
- Stiffeners, pins, connectors and full turnkey electronics packaging for efficient integration into your application
- Inductive communication coils can be integrated with flex circuits to provide critical communication assemblies

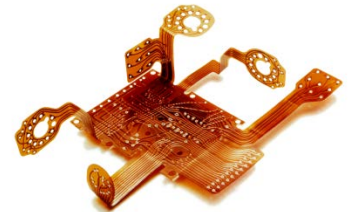

Integrated Solutions

All of Minco's products – Thermofoil™ Heaters, Flex Circuits, Sensors, Instruments – can be integrated into a single component for greater efficiency. Whether it is a complete thermal optimization system or interconnection application, Minco's design engineers will partner with you to ensure success.

With integrated solutions there is less work on your end, and less that can go wrong. Our integrated assemblies truly lower your total cost of ownership (TCO) because of less front end assembly, easy installation, and unparalleled quality and reliability.



Request a Quote

Providing information for a quote

Information required for a ballpark quote

- Quantity desired
- Number of layers
- General size of the circuit
- Features such as stiffeners, pins, connectors, etc.

Information required for a firm quote

- Drawing, including complete physical shape
- CAM data of all stack-up layers (ODB++ or Gerber data preferred) - unless Minco is to generate
- Quantity required
- Materials: conductors, insulators, stiffeners, other
- Number of layers
- Plating requirements
- Applicable specifications
- Impedance requirements (if applicable).
- Unusual areas of the circuit that Minco should be aware of, such as unbonded or cut-away areas
- Tolerances clearly outlined (geometric profile preferred)
- Other requirements: conductor spacing, conductor width, border, etc.
- Special marking and/or packaging requirements
- Testing requirements: type, percent to be tested, and frequency. Is IPC-6013 testing required?
- Additional components that Minco is expected to supply/assemble (inform Minco of preferred suppliers if the components are unique).

Information required for manufacturing

All the information that is required for a firm quote, plus:

- Dimensional drawing including notes and requirements
- CAD/CAM data (unless Minco is to generate)
- Netlist if Minco is to perform electrical testing
- Schematic plus electrical performance requirements if Minco is to generate CAD data.

Supplying drawings

The "perfect drawing" will provide the following information:

- Cross-section diagram (i.e. material stack-up)
- Outline drawing of circuit
- Material listing
- Specifications
- Hole chart
- Feature chart (i.e. minimum conductor width and spacing, and any other minimum spacing requirements)

- Dimensional tolerances
- Special plating requirements
- Marking requirements
- Testing requirements
- Electrical requirements
- Special packaging requirements

Specify testing requirements

Testing is labor intensive and will directly impact costs and delivery schedules. Some tests are automated, others are manual. Test frequency must be considered as well as the destructive nature of some tests. All tests are documented, and certificates of conformance are routine for Minco.

Test requirements must be documented to avoid any confusion. Your sales and design engineer contacts can discuss these needs with you.

Physical testing options include, but are not limited to

- Dimensional measurements
- Ionic contamination
- Thermal shock
- Solderability

Electrical testing options include, but are not limited to

- Resistance
- Insulation resistance (IR)
- Continuity
- Inductance
- Capacitance
- Sencore Ringer
- Dielectric, net-to-net
- Dielectric, high potential test of exterior insulation
- Impedance

Note: Standard electrical testing includes continuity (5 Ω) and insulation resistance (40 m Ω @ 150 VDC).

Artwork checklist

Minco strongly encourages customers to use the artwork checklist provided. If you answer 'yes' to all the criteria, your artwork will probably not need adjustment.

Note: Depending on the size/complexity of the circuit, the criteria may differ.

Dimensions

- Does the border match the print dimensionally?
- Does the artwork match the print dimensionally?

Etched marking (if any)

- Are all features of letters and symbols at least 0.003" (0.076mm) line width/0.020" (0.508mm) tall characters minimum (more preferred)?
- Are letters and symbols clear of conductors and borders?

Border and cutouts

- Is there a trim border (part outline) on at least one layer?
- Do nominal borders allow for tolerances in the table on page 10?

Non-wiring hole clearance

- Are non-wiring holes at least 0.007" (0.18mm) (more preferred) over the specified minimum distance from conductors and borders?

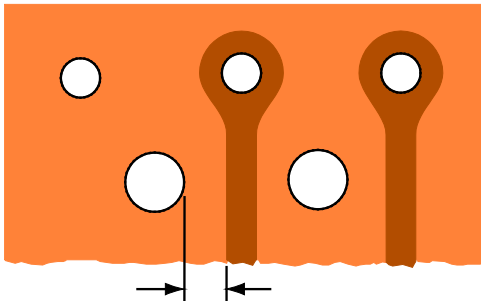

Conductor width

Is the CAD design conductor width:

- at least 0.001" (25 μ m) over the specified minimum for unplated 1/2 oz. (18 μ m) copper?
- at least 0.002" (100 μ m) over the specified minimum for unplated 1 oz. (35 μ m) copper?
- at least 0.004" (125 μ m) over the specified minimum for plated copper layers?

Conductor spacing

Is CAD design conductor space:

- at least 0.001" (25 μ m) over the specified minimum for all unplated copper?
- at least 0.002" (50 μ m) over the specified minimum for all plated copper layers?

Conductor routing

- Are conductors perpendicular to bend lines?
- Have you avoided the I-beam effect?

Pads and annular rings

- Are there pads on all layers for all plated through-holes?

- Are non-exposed pads (via pads) 0.014" (0.51mm) larger than the through-holes (not applicable for micro vias)?
- Are center locations provided for all drilled holes and/or slots?
- Are the annular rings on all holes at least 0.007" (0.18mm) larger than the specified minimum?
- Are access holes in cover layers at least 0.007" (0.18mm) (more preferred) over the specified minimum distance from conductors and borders?
- Are all pads filleted?

Designing CAD artworks

This section provides the information necessary for designing CAD artworks that will meet the tolerance and quality requirements for a flex circuit. A correctly designed artwork will prevent unnecessary and costly delays in the initial shipment.

Most CAD artwork is customer supplied. Minco can generate CAD artworks at additional cost. To generate an artwork, Minco needs:

- Outline dimensions and tolerances.
- Location and size of conductor pads.
- Minimum conductor widths, minimum spaces between conductors and conductor thickness. These will depend on current carrying capacity, impedance, dielectric, and the flexibility requirements of the circuit.
- Net list
- Conductor paths can be captured from a net list or schematic when required. A design charge may apply.
- Locations where the circuit will be bent, if any, and required flexibility at these locations (i.e. bending for installation or a dynamic application).
- We prefer that you supply CAD generated data. If you cannot furnish CAD data, we can digitize a physical artwork at additional cost.

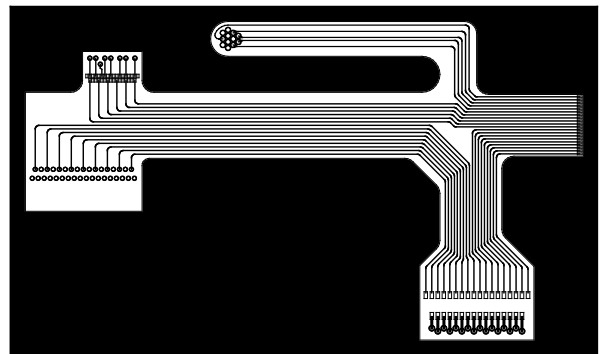

CAD-generated artwork

CAD/CAM data guidelines

Minco can accept CAD/CAM data in the following forms

- ODB++ database format is preferred
- Gerber data, RS-274X format (embedded aperture) is acceptable.
- Gerber data, RS-274D Gerber data with separate, detailed aperture list can be used, but is not preferred.
- AutoCAD DXF (2D)
- AutoCAD DWG (2D)
- Solidworks drawing (.SLDDWG)
- IPC-D-356 netlist

Other formats may be acceptable — contact Minco for details.

Guidelines for all formats

- Single entity draws for conductors are required.
- Single pad flashes are required.
- Minimize the entities used to create conductor to pad transitions (“fillets”).

Guidelines for DXF

- Place artwork data, part outline, hole centers, soldermask, coverlay, screen marking, etc. on separate, individual CAD system layers.
- Polygons or zero width line draws for irregular pad shapes and shield area outlines are preferred (instead of filling in these shapes).
- Supply arcs and circles. Do not convert arcs or circles into segmented lines.
- Avoid supplying only conductor outlines, as it increases set-up cost. If you do supply conductor outlines, include supporting CAD system layer with proper line width conductors and pads.

Guidelines for Gerber

When sending your photoplotter code, please include:

- The format of the data
- An aperture wheel listing (when required)
- A list of layers with descriptions
- The number of files supplied

E2E — Engineer to Engineer

Early engineering involvement

Quality, robust flex designs are achieved when the designer understands that flexible circuits are as much a mechanical component as they are electrical. Engineering consultation can be invaluable early in the design process. Minco wants to make your access to

engineering tools and expertise as convenient as possible.

Minco engineer review

Our engineers will review your quote or order documentation and data to determine if changes are needed for manufacturability. If needed, we will discuss these issues with you to our mutual agreement before construction begins.

Design services

Concept to finish or problem specific, design engineers are available to assist our customers. Contact Minco to begin working with the design engineer most able to help you with your specific design needs.

Ordering and Delivery

Place your order with Minco

When you receive your Minco quote, you may see an itemized list of comments regarding your circuit. Please thoroughly review your Minco quote. Placement of an order includes acceptance of all terms, conditions, exceptions and substitutions. Our sales professionals are happy to discuss any questions you have regarding your Minco quote.

When placing your order, include final design data, drawings, and procurement documentation reflecting your expectations and Minco’s DFM changes. Clarity is key to Minco’s relationships with customers.

All quality clauses and expectations should be detailed during the RFQ/Quote stage.

Send your purchase order and all other required information to sales@minco.com.

Delivery information

Lead times may vary depending on design and work flow requirements.

Production models will follow our best practices and applicable lead times. Delivery times and quality are predictable for all standard designs.

Prototype/quick-turn models can be fully compliant with all drawing and specification requirements, or simply meet “form, fit, function” requirements. Contact Minco for assistance with your design concept needs.

Glossary

Access hole

A hole in the cover layer of a circuit that allows electrical access to a flex circuit's conductor pads and through-holes.

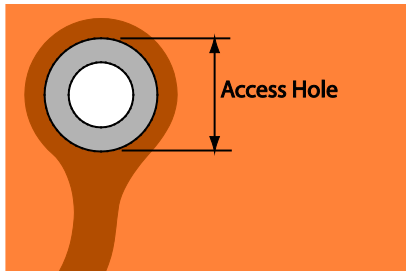

Annular ring

The minimum width of the exposed copper or solder that surrounds a flex circuit's through-holes.

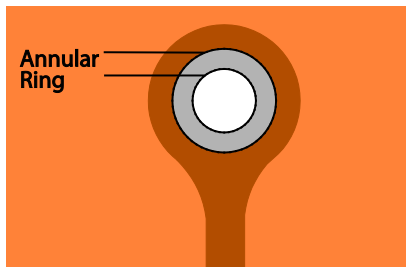

CAD data

Formerly called "artwork": the original electronic pattern of conductor strands, holes, outline, and other required features defining a flexible circuit.

Chemically milled die (CMD)

A tool used in a punch press with blades formed by a chemical milling process, and mounted on an aluminum base.

Conductor

The path that carries electrical current from one point to another. Minco's flex circuit conductors are commonly in the form of copper strands.

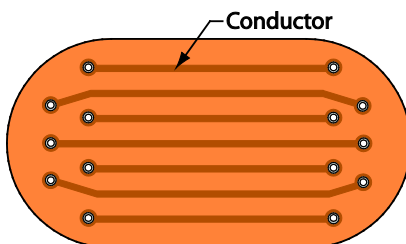

Conductor spacing

The distance between conductor strands or pads. A certain minimum conductor spacing must exist in order to prevent conductors from shorting together.

Conductor width

The width of a conductor measured across its base.

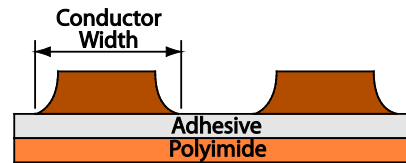

Cover

Insulator material laminated to an etched element. Covers can be located on the inner or outer layers. Internal cover layers are found in the unbonded regions of a circuit.

Dynamic application

An application using a flex circuit that requires repeated flexing while in use.

Flex circuit

Flexible printed circuits made from etched foil conductor strands. The conductor strands are laminated between insulating layers.

Flex-Coil™

Flex circuits with internal or attached wire-wound coils.

Hold-down tabs

An extension of foil on a conductor pad that aids the pad in gripping to the substrate insulation. Hold-down tabs are also referred to as "anchoring spurs" and provide mechanical strength.

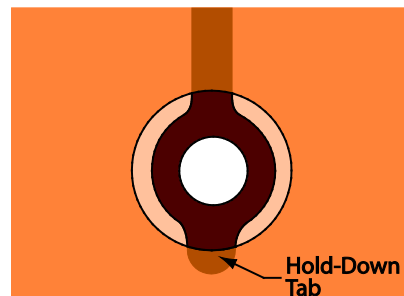

I-beam effect

The tendency of a flex circuit to have reduced flexibility and to fracture conductor strands if the conductor strands are layered directly over each other, instead of being staggered from layer to layer.

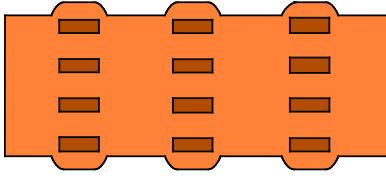

Impedance

The measurement in ohms of the apparent resistance of an AC circuit. Impedance depends on several factors: DC resistance, capacitance, inductance of the line, the width of the conductor strands, and the conductor spacing relative to ground and insulating layers.

Major access hole

An access hole (see "Access hole") that is large enough to expose a major portion of a conductor pad, which is usually coated with solder.

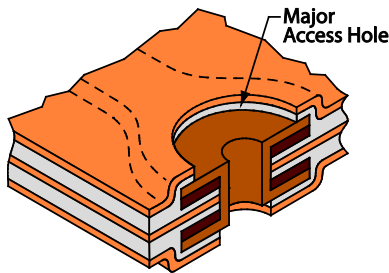

Minor access hole

An access hole (see "Access hole") that exposes only a very small portion of a conductor pad, used on holes where a solder pad is not needed or desired. The cover hole must still be larger than the through-hole to allow for normal registration tolerances. Generally against a component or a stiffener.

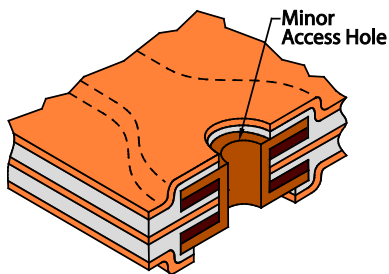

Nesting

Designing circuits so that they lay closely together on a panel during production. This maximizes the usage of panel space, which minimizes production cost.

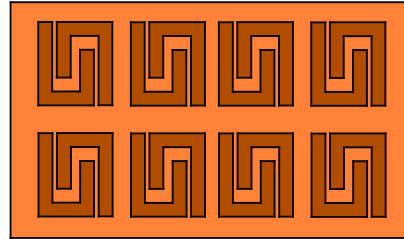

Pad

The portion of a conductor, usually surrounding a through-hole, that is used to connect a component for an electrical connection. Pads are sometimes referred to as "terminals" or "lands."

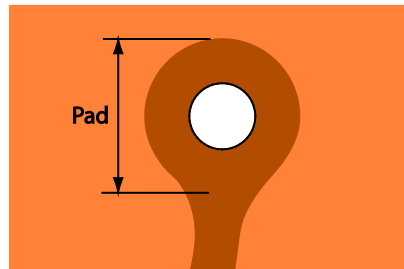

Profile tolerance

Dimensional tolerancing where the part trim line is contained within a tolerance zone consisting of the area between two parallel lines, separated by the specified tolerance. For example, a circuit to be trimmed with a steel rule die might have a tolerance of 0.015" (0.38mm) – a 0.030" (0.76mm) wide profile tolerance zone. The circuit trim line could vary anywhere inside the zone.

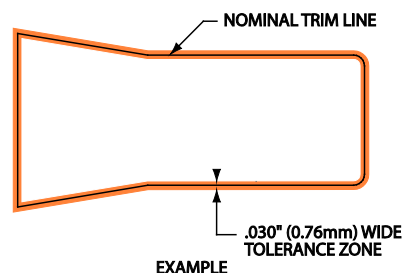
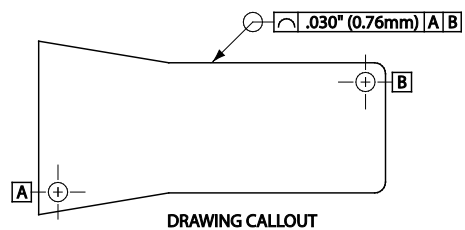

Punch-and-die

Hard-tooling that is used in a punch press. A punch-and-die consists of two precisely matched metal plates held in special die shoes. When the punch press is activated, the plates come together in order to punch a specific pattern into material.

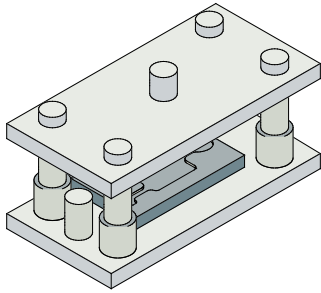

Rigid-flex

A circuit containing both rigid and flexible areas. The rigid layers have conductors and plated through-holes connecting them to other layers.

Selective plating

A method of plating flex circuits so that only the circuit's through-holes and surrounding pads are plated. This greatly adds to a circuit's flexibility.

Static application

An application using a flex circuit that requires minimal flexing during installation and equipment maintenance only.

Steel rule die (SRD)

A tool used in a punch press, consisting of steel cutting blades in a pattern, embedded into a plywood or synthetic base.

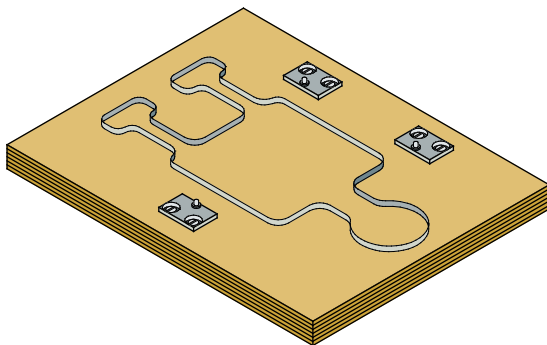

Stiffener

Flexible or rigid pieces of material (usually polyimide or FR-4) added to flex circuits to reinforce them for component mounting. There are no conductors on stiffeners, as compared to rigid-flex circuits.

Substrate

A layer of insulator bonded on one or both sides with foil.

Tangency

A condition that occurs when the edge of a stiffener or cover access hole is flush with the edge of a through-hole.

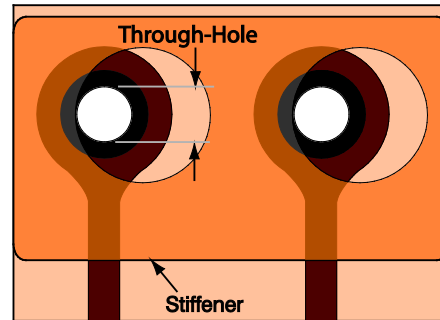

Tear stops

Copper, polyimide, or Teflon guards that are located in the inner corners of polyimide-insulated flex circuits in order to prevent propagation of tears.

Through-holes

Holes that are drilled through the layers of a flex circuit in order to have component access to those layers. Connection from one layer to the next is provided by plating the through-hole walls with a thin layer of copper.

Trim line

The area defined as the final cut-out area around a flex circuit.

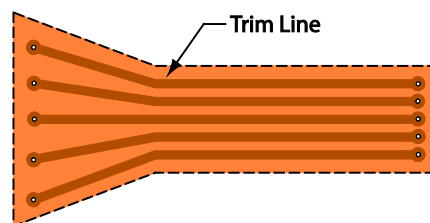

Unbonded areas

A flex circuit design technique that involves providing an insulating layer between every conductive layer of a flex circuit, but with no adhesive bonding between the insulating layers in certain areas of the circuit. This technique improves circuit flexibility.

Via

A plated through-hole with no cover access holes that provides connection for internal layers.

Next Steps

Minco welcomes the opportunity to help you design and manufacture a product that meets or exceeds your expectations. That is why we have established a variety of communication channels to encourage meaningful exchange and dialog.

Contact Minco

Minco's customer service team is trained and equipped to promptly handle complex questions regarding product orders, quote requests, engineering questions, and other issues that require comprehensive customer support.

Phone: 763.571.3121

Fax: 763.571.0927

Email: sales@minco.com

Get a mechanical sample of your flex circuit

Take advantage of Minco's offer to build a flex circuit mechanical sample that will help you avoid installation problems or mechanical issues that could cause failures. Follow the instructions provided in the "How to Get Started" section of this guide.

Submit a request for quote

Send us your application specifications and component needs, and a Minco Representative will contact you by phone or email to confirm your request and will send you a reliable quotation.

www.minco.com