



# FLEXIBLE HEATERS DESIGN GUIDE

Flexible Thermofoil™ Heating Solutions | Polyimide, Silicone Rubber, Mica, Thermal-Clear™  
Precision Heating for Medical Diagnostics, Defense, Aerospace, Telecommunications & Other High Reliability Industries

The logo for MINCO, featuring the word "MINCO" in a bold, blue, sans-serif font. A small orange triangle is positioned above the letter "I".

# Minco: A Critical Component of your Success

Minco has been designing and manufacturing critical components since 1956. During the past five decades, we've grown into a global company with four product lines:

Flexible Thermofoil™ Heaters



Flex Circuits



Sensors



Instruments



Minco has established working relationships with the design engineering teams at thousands of customers, freely sharing our design and manufacturing knowledge and experience. Our inclusive design process creates win-win opportunities for both our customers and Minco, which shortens design cycles and strengthens valuable relationships. All of this makes Minco a trusted partner and provider of critical components for the world's most critical applications.

## Superior heating solutions

Minco works diligently to provide the best heating solution for your application. We've developed the unsurpassed ability to design and assemble all of our products into a single integrated component so you can achieve the highest degree of functional and packaging efficiency.

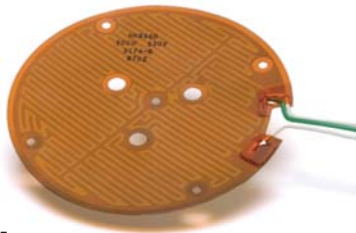

Minco can integrate temperature sensors, controllers, SMT components, flex circuitry and other electronics into your heating application to provide a complete turnkey solution. This allows you to save time and money while increasing your organizational flexibility.

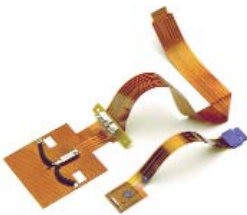

## Minco today: global and growing

Minco's engineering and manufacturing plants employ over 1000 people worldwide. More than 300,000 ft<sup>2</sup> (27,900 m<sup>2</sup>) of manufacturing space provides the capacity and infrastructure to support a variety of applications for global customers in diverse markets.

Minco's seamless operational capabilities allow us to design and manufacture integrated components from prototype to production, which simplifies the supply chain and improves our response time.

Minco is ISO 9001:2000 / AS/EN/SJAC9100 (Registrar: TÜV) certified and we have the capabilities to meet many other quality assurance, process, and product specifications per your requirements.



Minco's team of engineers, customer support professionals and sales professionals are available to help make your project a success. Call Access: Minco Sales and Support or get technical information and educational material online at [www.minco.com](http://www.minco.com).



# Thermofoil™ Solutions for Heating

## Flexible Thermofoil™ Heaters

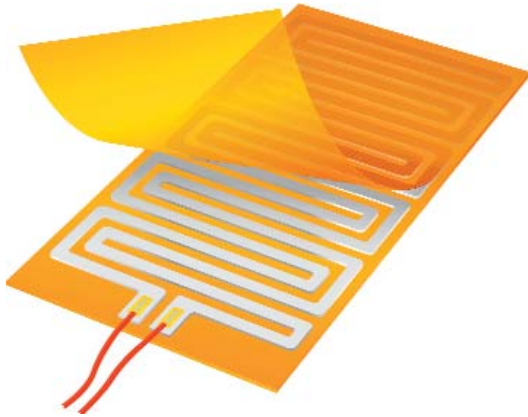

Thermofoil™ heaters are thin, flexible components consisting of an etched-foil resistive heating element laminated between layers of flexible insulation. Since their introduction by Minco over 45 years ago, Thermofoil heaters have demonstrated significant advantages over conventional electric heaters.

### Precise heating

Thermofoil heaters put heat where you need it. You simply apply them to the surface of the part to be heated. The thin construction provides close thermal coupling between the heater element and heat sink. You can even specify profiled heat patterns with higher watt densities in areas where heat loss is greater.

### Faster warmup and longer life

The flat foil element of Thermofoil heaters transfers heat more efficiently, over a larger surface area, than round wire. Thermofoil heaters, therefore, develop less thermal gradient between the resistive element and heat sink. Heaters stay cooler. The result is higher allowable watt densities, faster warmup, and prolonged heater life. Thermofoil heaters can safely run at wattages twice those of their wire-wound equivalents. Insulation life may be ten times greater. For high levels of reliable heat, the obvious choice is Thermofoil.

### Space and weight savings

A polyimide (e.g. Kapton™) heater typically weighs only 0.009 oz/in<sup>2</sup> (0.04 g/cm<sup>2</sup>) and measures just 0.010" (0.25 mm) thick over the element. For applications with limited space — defense electronics, aircraft, portable medical instruments, high density electronic devices — Thermofoil heaters deliver the heat you need.

## Custom and integrated components

Minco operates four different product divisions, all coordinated in the same facility for faster, seamless integration that can boost your time-to-market. This makes us unique in our ability to customize and integrate components into turnkey assemblies and complete thermal, sensing and flex circuitry solutions. All of our components can be designed, manufactured, and integrated to perfectly fit your application while providing matched system accuracy.

We can furnish heaters with integral resistance thermometers, thermocouples, thermistors, or thermostats. Minco controllers can monitor sensors and power heaters for tight control and accuracy. And, with flex circuit capabilities and in-house pick-and-place equipment, control circuitry can be incorporated in the same assembly to save you assembly time and cost.

## Custom tailored for better fit

Size and shape possibilities are limitless. Minco can manufacture heaters as large as 8 feet (2.4 m) long, and smaller than 0.25" x 0.25" (6.4 mm x 6.4 mm). You can specify intricate geometries to follow the bumps and curves of your hardware at the same time designing the heater for best accuracy and reliability.

## Value-added assembly

As an added service, Minco can laminate, vulcanize, or clamp heaters to mating heat sinks. Our specialized equipment guarantees tight bonds, high reliability, and superior performance. We can mount the heater to your furnished parts, or provide machined heat sinks to offer you a complete turnkey solution.

## Best fit — best price

Minco's custom heaters are typically more cost effective than our standard models at OEM quantities (e.g. 500+ pieces). Start with our off-the-shelf solutions for experimentation and proof-of-concept testing. Then, we'll work with you to optimize a custom solution. Contact us early in the design process so our expert engineers can help you design the best and most efficient heating solution available. Call Access: Minco Sales and Support today.

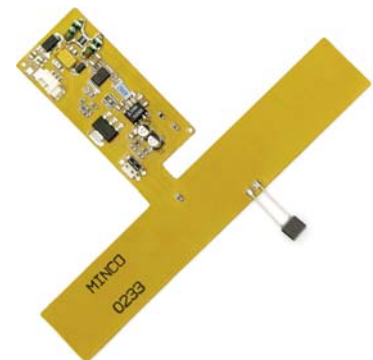

# Solutions for Industry Applications

## Medical Diagnostics

Minco's flexible Thermofoil heaters, flex circuits and sensors provide a turnkey solution for this point-of-care blood analyzer. The integrated component design improves reliability and reduces cost from the original design by eliminating 3rd party wire harnesses and printed circuit boards (PCBs).

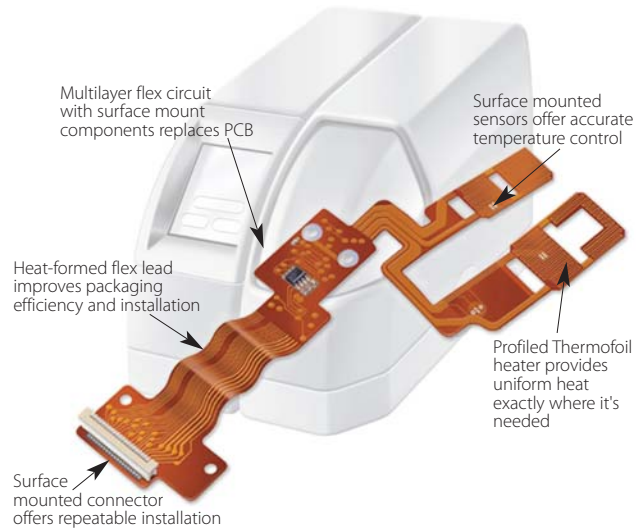

## Defense and Aerospace

Flexible Thermofoil heaters are used in Defense and Aerospace applications where ruggedness and reliability in harsh conditions is required. This profiled polyimide heater with integrated flex lead and temperature sensor provides critical anti-condensation heating in helmet mounted micro-displays.

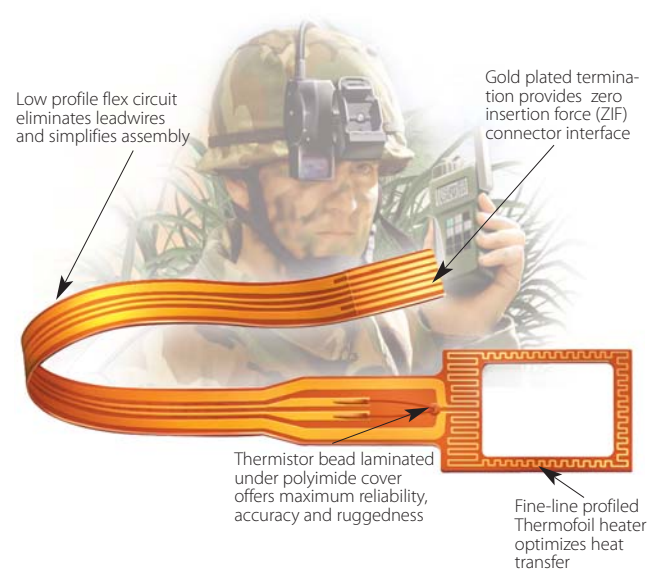

## Telecommunications

A partnership between Minco's design engineers and our customer's engineers fostered the collaboration needed to manufacture this affordable silicone rubber heater assembly vulcanized to a finned heat sink. Minco's Thermofoil heater is designed to keep electronics, fiber optics and amplifiers operating optimally for 15+ years in above or below-ground enclosures.

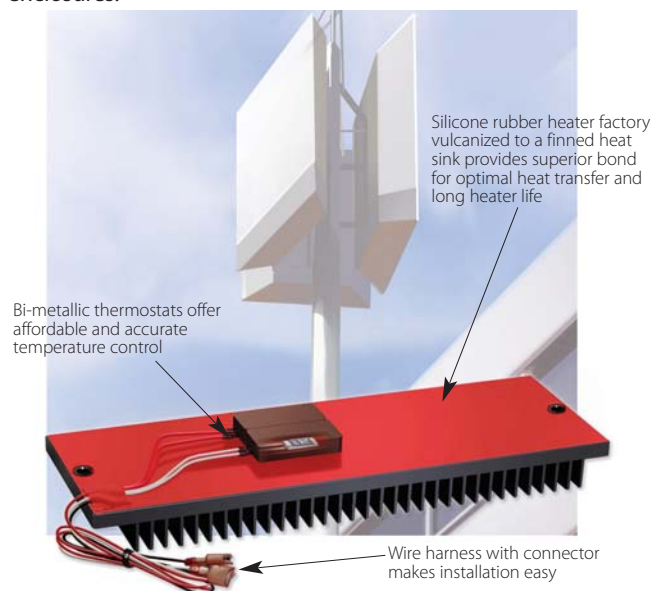

## Other Applications

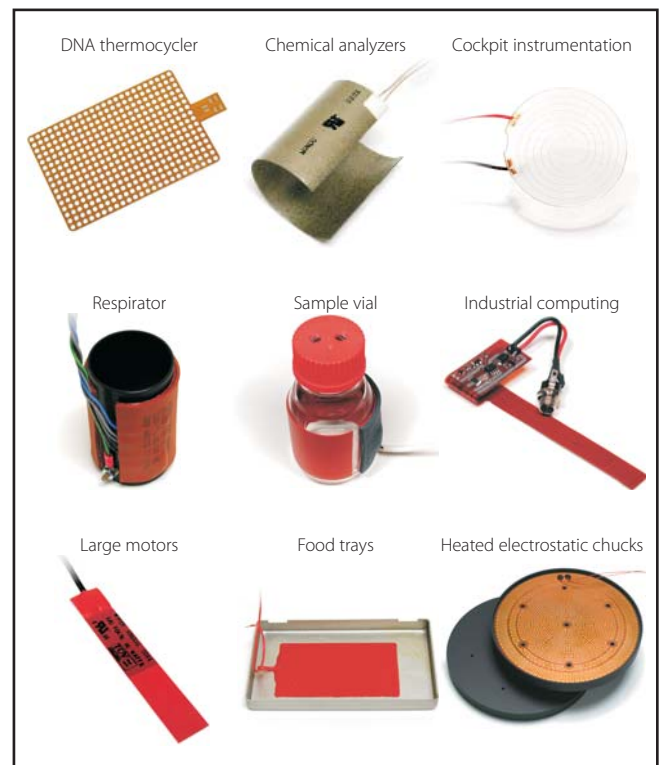



# Selecting a Minco Heater

## 1. Choose insulation type

Pick from the available insulation types. When selecting insulation consider temperature range, maximum resistance density and maximum heater size. Insulation options are available on page 7.

## 2. Choose installation option

Proper installation is crucial for optimal heater performance. Determine the best method to install flexible heaters in your application so you can achieve desired results in your thermal system. Minco installation options are available on page 8.

## 3. Calculate required wattage

The heater you select must produce enough power to (1) warm the heated object to control temperature in the desired time and (2) maintain that temperature.

The specific heat formula on page 10 gives an estimate for warm-up, assuming all heat enters the object and none is lost. Add at least 20% to account for unknown losses.

Heat loss factors include conduction, convection, and radiation. A more accurate wattage estimate will take these into account. For a general discussion of heat loss, download Minco White Paper "Estimating Power Requirements for Etched-Foil Heaters." Also helpful is Thermal Calc, an online tool to assist with calculations. Both are available at [www.minco.com](http://www.minco.com)

## 4. Select a Minco stock or standard heater

Select from the hundreds of available heater sizes in this guide that will best fit your application. Multiple resistance options will allow you to carefully manage your heat output.

### Ohm's Law

A Thermofoil heater has a specific resistance. Its power output, in watts, depends on supply voltage ( $P=E^2/R$ ).

| R<br>Ohms ( $\Omega$ ) |                 |                 | P<br>Watts (W) |        |                 | I<br>Amps (A)        |               |               | E<br>Volts (V) |               |      |
|------------------------|-----------------|-----------------|----------------|--------|-----------------|----------------------|---------------|---------------|----------------|---------------|------|
| $\frac{E}{I}$          | $\frac{E^2}{P}$ | $\frac{P}{I^2}$ | $EI$           | $I^2R$ | $\frac{E^2}{R}$ | $\sqrt{\frac{P}{R}}$ | $\frac{P}{E}$ | $\frac{E}{R}$ | $\sqrt{PR}$    | $\frac{P}{I}$ | $IR$ |

## 5. Test and prototype

The best way to make a final determination of heat requirements is by experimentation. See page 10 for tips, or download Minco's white paper entitled "Prototyping Techniques for Etched-Foil Heaters," available at [www.minco.com](http://www.minco.com)

| Desired temperature | 60°C   | 100°C  | 100°C (same as left)                                    | 150°C  |
|---------------------|--|--|---|--|
| Power required      | 300 W at 115 V   | 500 W at 240 V   |   | 2500 W at 480 V  |
| Heater size         | 3" x 6" (76.2 x 152.4 mm)                                    | 2" x 10" (50.8 x 254 mm)                                     |   | 9" (228.6 mm) diameter                                       |
| Ideal resistance    | $115^2/300 = 44.1 \Omega$                                    | $240^2/500 = 115 \Omega$                                     |   | $480^2/2500 = 92.2 \Omega$                                   |
| Mounting method     | BM3 shrink band  | #6 RTV cement  | Factory vulcanized                                      | Clamped  |
| Insulation          | Polyimide  | Silicone Rubber  |   | Mica   |
| Model chosen        | HK5468 R46.1 L12 A   | HR5430 R96.8 L12 A   |   | HM6810 R83.4 L12 T2  |
| Effective area      | 15.74 in <sup>2</sup> (101.5 cm <sup>2</sup> )               | 18.20 in <sup>2</sup> (117.4 cm <sup>2</sup> )               |   | 58.5 in <sup>2</sup> (377.4 cm <sup>2</sup> )                |
| Actual power        | $115^2/46.1 = 287$ W   | $240^2/96.8 = 595$ W   |   | $480^2/83.4 = 2762$ W  |
| Watt density        | $287/15.74 = 18$ W/in <sup>2</sup> (2.79 W/cm <sup>2</sup> ) | $595/18.20 = 33$ W/in <sup>2</sup> (5.12 W/cm <sup>2</sup> ) |   | $2762/58.5 = 47$ W/in <sup>2</sup> (7.29 W/cm <sup>2</sup> ) |
| Max. watt density   | 36 W/in <sup>2</sup> (5.58 W/cm <sup>2</sup> ) at 60°C       | 19 W/in <sup>2</sup> (2.95 W/cm <sup>2</sup> ) at 100°C      | 36 W/in <sup>2</sup> (5.58 W/cm <sup>2</sup> ) at 100°C | 54 W/in <sup>2</sup> (8.37 W/cm <sup>2</sup> ) at 150°C      |
| Wattage density OK? | Yes (18 < 36)  | No! (33 > 19)  | Yes (33 < 36)   | Yes (47 < 54)  |

# Heater Insulations



| Material                       | Temperature range               | Max. size                     | Max. resistance density*                        | Comments   |
|--------------------------------|---------------------------------|-------------------------------|---|--|
| <b>Polyimide/FEP</b>           | -200 to 200°C<br>-328 to 392°F  | 560 mm × 1065 mm<br>22" × 42" | 70 Ω/cm <sup>2</sup><br>450 Ω/in <sup>2</sup>   | See technical specifications on pages 16-18  |
| <b>Silicone rubber</b>         | -45 to 235°C<br>-49 to 455°F    | 560 mm × 2285 mm<br>22" × 90" | 31 Ω/cm <sup>2</sup><br>200 Ω/in <sup>2</sup>   | See technical specifications on pages 20-21 (foil)<br>See technical specifications on pages 32-33 (wire-wound) |
| <b>Mica</b>                    | -150 to 600°C<br>-238 to 1112°F | 560 mm × 1168 mm<br>22" × 46" | 3.9 Ω/cm <sup>2</sup><br>25 Ω/in <sup>2</sup>   | See technical specifications on pages 36-38  |
| <b>Optical grade polyester</b> | -55 to 120°C<br>-67 to 248°F    | 280 mm × 560 mm<br>11" × 22"  | 185 Ω/cm <sup>2</sup><br>1200 Ω/in <sup>2</sup> | See technical specifications on pages 39-40  |

Design Guide

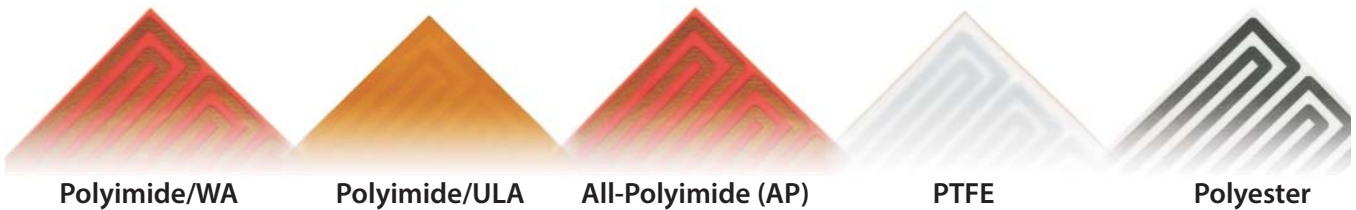

| Material  | Temperature range              | Max. size                     | Max. resistance density*                        | Comments  |
|---|--------------------------------|-------------------------------|---|---|
| <b>Polyimide/WA</b><br>Polyimide film with thermosetting acrylic adhesive (not UL recognized) | -200 to 150°C<br>-328 to 302°F | 560 mm × 1825 mm<br>22" × 72" | 230 Ω/cm <sup>2</sup><br>1500 Ω/in <sup>2</sup> | Similar to Polyimide/FEP except lower cost, higher resistance densities, and lower temperature range. WA is preferred over FEP for most custom designs under 150°C. |
| <b>Polyimide/ULA</b><br>Polyimide film with UL recognized thermosetting acrylic adhesive      | -200 to 150°C<br>-328 to 302°F | 560 mm × 1825 mm<br>22" × 72" | 230 Ω/cm <sup>2</sup><br>1500 Ω/in <sup>2</sup> | Similar to Polyimide/WA except UL recognized (UL94V-0).   |
| <b>All-Polyimide (AP)</b><br>Polyimide film with polyimide adhesive                           | -200 to 260°C<br>-328 to 500°F | 560 mm × 1145 mm<br>22" × 45" | 230 Ω/cm <sup>2</sup><br>1500 Ω/in <sup>2</sup> | Higher temperatures and watt densities than industry standard flexible Polyimide construction.  |
| <b>PTFE</b>   | -200 to 260°C<br>-328 to 500°F | 254 mm × 1016 mm<br>10" × 40" | 70 Ω/cm <sup>2</sup><br>450 Ω/in <sup>2</sup>   | Fully sealed construction suitable for immersion in acids, bases, and other corrosive chemicals.  |
| <b>Polyester</b><br>(with thermosetting adhesive)   | -40 to 105°C<br>-40 to 221°F   | 560 mm × 1825 mm<br>22" × 72" | 217 Ω/cm <sup>2</sup><br>1400 Ω/in <sup>2</sup> | Low cost material for economic fabrication of large heaters.  |

\*Resistance density varies with the size of the heater (higher density possible with smaller heaters).

Specifications subject to change



# Heater Installation

Versatile Thermofoil heaters allow a variety of mounting methods.

Proper installation is crucial to heater performance. The heater must be in intimate contact with the surface beneath, as any gaps can block heat transfer and cause a hot spot resulting in premature heater failure.



Proper installation ensures good heat flow from the heater to the heat sink

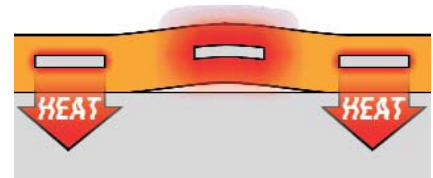

Voids or bubbles beneath the heater cause localized hot spots which can result in premature heater failure

## Pressure-sensitive adhesive (PSA)



With factory-applied PSA, you simply remove the backing paper and press the heater in place.

| Description   | Temperature rating              | Comments   | Installation Instruction* |
|---|---------------------------------|--|---------------------------|
| <b>Acrylic PSA</b><br>0.002" (0.05 mm) acrylic film | See heater ordering information | <ul style="list-style-type: none"> <li>NASA approved for outgassing</li> <li>Flat surfaces only, unless aluminum backed</li> </ul> | EI 138                    |
| <b>#12 PSA</b><br>0.002" (0.05 mm) silicone film    |                                 | <ul style="list-style-type: none"> <li>Flat or slightly curved surfaces</li> </ul>   | EI 266                    |

## Epoxy and cement



Liquid adhesives require more care in application than PSA, but generally provide higher temperature/wattage performance.

| Description  | Temperature rating           | Comments  | Engineering Instruction* |
|--|------------------------------|---|--------------------------|
| <b>#6 RTV cement</b><br>Room temperature vulcanizing silicone for rubber heaters | -45 to 235°C<br>-49 to 455°F | <ul style="list-style-type: none"> <li>Distance from center of heater to edge must be less than 5" (127 mm)</li> <li>3 oz. (85 g) tube covers 800-1300 in<sup>2</sup> (5000-8000 cm<sup>2</sup>)</li> </ul> | EI 117                   |
| <b>#15 epoxy</b><br>2-part epoxy for Polyimide heaters                           | -70 to 115°C<br>-94 to 239°F | <ul style="list-style-type: none"> <li>NASA approved for outgassing</li> <li>Bi-pack covers 150-300 in<sup>2</sup> (900-1800 cm<sup>2</sup>)</li> </ul>   | EI 507                   |

## Easy installation methods for cylindrical surfaces



Built-to-order shrink bands are pre-stretched strips of film with adhesive coated ends. Wrap around the heater and heat to shrink. Stretch tape installs quickly with no heat required.

| Description  | Temperature rating            | Comments   | Engineering Instruction* |
|--|-------------------------------|--|--------------------------|
| <b>BM3 shrink band</b><br>Polyester strip            | -73 to 149°C<br>-100 to 300°F | <ul style="list-style-type: none"> <li>To order, specify band width and cylinder diameter</li> </ul>   | EI 103                   |
| <b>BK4 shrink band</b><br>Polyimide strip            | -73 to 177°C<br>-100 to 350°F |  |                          |
| <b>#20 stretch tape</b><br>Self-fusing silicone tape | -51 to 200°C<br>-60 to 392°F  | <ul style="list-style-type: none"> <li>Comes in 6 or 36ft (1.8 to 11 meters) rolls, 1" (2.54 cm) wide. Figure 25% overlap when calculating length required.</li> </ul> | EI 124                   |

## Clamping

Mechanical clamping is required for mica heaters, optional for polyimide, but not recommended for rubber. Call Minco and ask for Minco Installation Instruction EI 347 or go to [www.minco.com](http://www.minco.com)

## Factory vulcanization and lamination

See page 13 for information on high-performance bonding of heaters to mating parts.

*Specifications subject to change*

# Maximum Watt Density

The watt density tables on this page show the maximum allowable power for each heater type, expressed in watts per square inch, or centimeter, of effective area. The rating depends upon the heater's insulation/internal adhesive, heat sink control temperature, and the mounting method.

If watt density exceeds the maximum rating, the heater is in danger of overheating and premature failure. To obtain more power:

- Select a larger size heater
- Consider other heater materials, e.g. mica
- Change the mounting method
- Use proportional control to reduce power as the heat sink temperature rises
- Contact Minco for product and design assistance

In addition to wattage, you should calculate the current (I) through the heater leadwires to keep it within the maximum rating for the AWG wire size used.

## Using watt density charts

1. Look up the effective area for the heater model in question. This is total heater area minus borders and lead attachment space (calculated by Minco).
2. Divide the power requirement in watts by this area to obtain watt density.
3. Draw a line from the heat sink temperature (at the bottom of the chart) to the line labeled with the mounting method and/or insulation you have chosen.
4. The maximum watt density is indicated by the value on the left or right axis that corresponds with that intersection.

## Silicone Rubber Heaters (foil)

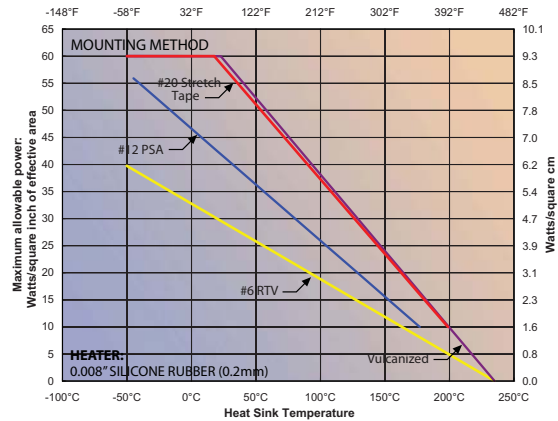

Note: Find the silicone rubber heaters (wire-wound) watt density chart on page 32

## Mica Heaters

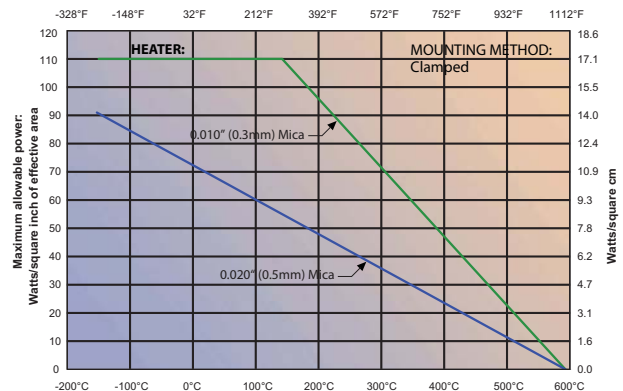

## Polyimide/FEP Heaters

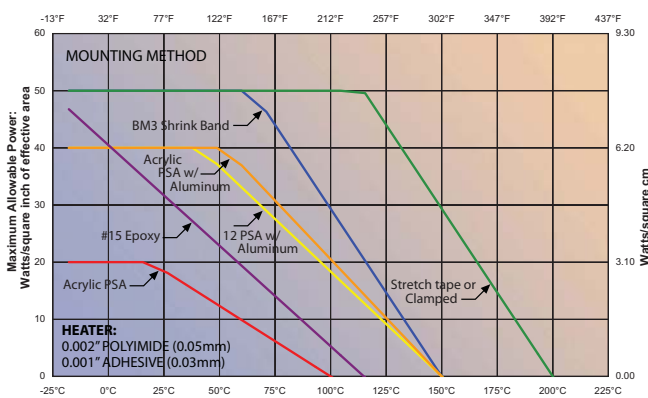

Note: Find the All-Polyimide heaters watt density chart on page 41

## Thermal-Clear™ Polyimide Heaters

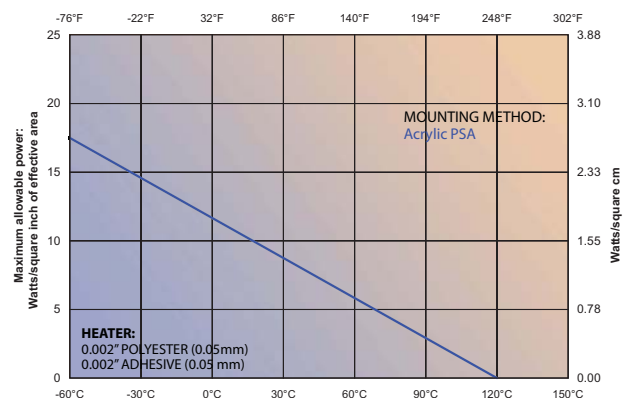



# Designing with Thermofoil Heaters

## Estimating power requirements

The total amount of power required for an application is the larger of two values:

1. Warm-up power + Heat lost during warm-up
2. Process heat + Heat lost in steady state

**Warm-up power:** Watts required to bring an object to temperature in a given time. The basic formula is:

$$P(\text{watts}) = \frac{mC_p(T_f - T_i)}{t}$$

where:

- $m$  = Mass of object (g)
- $C_p$  = Specific heat of material (J/g/°C)
- $T_f$  = Final temperature of object (°C)
- $T_i$  = Initial temperature of object (°C)
- $t$  = Warm-up time (seconds)

| Material          | Specific heat (J/g/°C) | Density (g/cm <sup>3</sup> ) |
|-------------------|------------------------|------------------------------|
| Air               | 1.00                   | 0.0012                       |
| Aluminum          | 0.88                   | 2.71                         |
| Copper            | 0.38                   | 8.97                         |
| Glass             | 0.75                   | 2.64                         |
| Oil (typical)     | 1.90                   | 0.90                         |
| Plastic (typical) | 1.25                   | Varies                       |
| Silicon           | 0.71                   | 2.32                         |
| Solder            | 0.19                   | 8.65                         |
| Steel             | 0.50                   | 7.85                         |
| Water             | 4.19                   | 1.00                         |

For other materials see Minco white paper "Prototyping Techniques for Etched-Foil Heaters" at [www.minco.com](http://www.minco.com)

To get: Multiply:  
 J/g/°C    BTU/lb/°F × 4.19  
 g/cm<sup>3</sup>    lbs/ft<sup>3</sup> × 0.016

**Process heat:** Heat required to process a material when the heater is performing useful work. The formula above also applies here, but must also include latent heat if material changes state (melts or evaporates).

**Heat loss:** All systems lose heat through convection (air or liquid movement), conduction through support structures, and thermal radiation.

## White Papers

Download these helpful white papers to assist in designing and testing with Thermofoil heaters:

- Estimating Power Requirements for Etched-Foil Heaters
- Prototyping Techniques for Etched-Foil Heaters

## Conducting experiments

Heat transfer theory is complex. It's usually best to prototype your system with actual heaters to observe behavior and fine-tune the design. Minco offers a variety of tools to help you:

**Design Kit:** The Flexible Heaters Prototype Design Kit (part number TB-H1) allows you to easily test and prototype a heating concept before starting on a journey of custom-built-to-order product.

Filled with flexible Thermofoil heaters, instructions and technical data, this kit will help you move towards successfully integrating flexible heaters into your application. Learn more at [www.minco.com](http://www.minco.com)

**Variable power source:** An AC power supply ("Variac"), power resistor, or rheostat lets you test different power levels across the heater or zone by zone.

**Temperature sensor(s):** A small Thermal-Ribbon RTD such as model S665 is easy to move and reapply to test temperature in various locations. See sensor options in the "Sensors, Controllers & Accessories" section.

**Controller:** Models CT325, CT15, and CT16A cover the range from simple to sophisticated design for testing control schemes. See controller options in the "Sensors, Controllers & Accessories" section.

A mosaic of standard heaters, with dual power supplies, helps to determine edge profiling for uniform temperature.

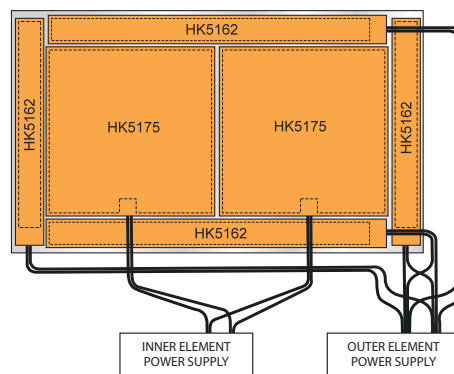

The resulting custom heater looks like this.

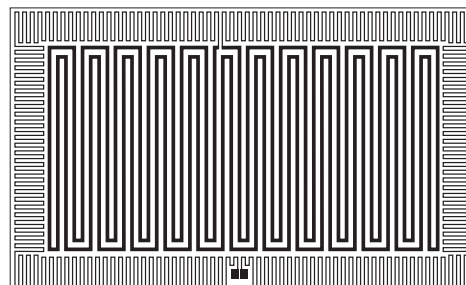

# Custom Design Options

## Heater designs to perfectly fit your application

Thermofoil heaters give you design options that other heater types can't match. Minco's custom design options can be quantified into three sections.

### Element design:

Element patterns, outline shapes, heat profiles and terminations can be fine-tuned to create the exact thermal and physical component to fit your unique requirements. Get more information below.

### Integrated components:

Integrating temperature sensors directly into the Thermofoil heater improves your thermal control while at the same time simplifying the end-use assembly operation. Get more information on page 12.

### Value-added services:

Complete thermal sub-assembly can provide a turnkey solution for your application. This could entail factory mounting of heaters to fabricated heat sinks, SMT control electronics to the Thermofoil heaters, incorporated rigid multi-layer flex circuits and connector termination. Get more information on page 13.

## Heater outline shapes

With a 3-dimensional approach the possibilities are endless. Select the proper Thermofoil heater insulation to meet your electrical and thermal performance requirements while at the same time satisfying your demanding packaging needs. Using selective adhesive backing configurations will also promote ease of installation of our heaters within smaller and smaller device spaces. Minco also has tooling and lasering capabilities which allows us to provide complex part outlines (holes, cut-outs, radii) with very tight dimensional tolerances.

Minco puts the heat where you need it, no matter how complex the shape

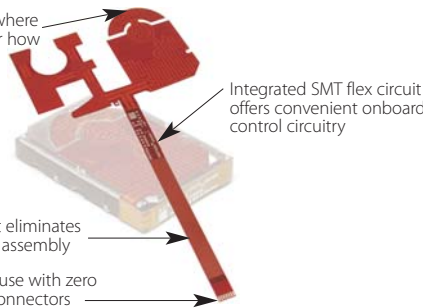

## Profiled heater conductor routing

A profiled element levels out temperature gradients by providing extra heat where losses occur, such as along edges or around mounting holes. In a typical case, profiling might reduce a  $\pm 25^{\circ}\text{C}$  temperature variation across a surface to  $\pm 5^{\circ}\text{C}$  or better. Once the best profile is determined for the application, Minco's photo-etching process ensures repeatability from heater to heater.

### Methods to derive the profiling pattern include:

- **Experimentation:** Lay out a pattern with standard heaters and vary the power levels until temperature reaches the desired uniformity. Or, Minco can provide a custom heater with separately powered zones for prototyping. Minco will then reproduce the successful profile with a single element.
- **Finite Element Analysis (FEA):** Although more expensive, FEA modeling of thermal systems can reduce the number of trials required to design a profiled heater. It may help to map the temperature resulting from uniform heat input (using a standard heater), then work backward in FEA to derive the profiled pattern.

Tight uniformity goals may require more than one profiling iteration, and a given solution is optimized for only one set-point temperature.

### Other heater element options

- Dual element for redundancy and/or warm-up and maintenance heating schemes
- Non-magnetic alloys for inductance canceling
- Dual layer constructions in order to provide higher resistance (ohms) in small areas or for added inductance canceling in element patterns

## Electrical termination

|                      |   |
|----------------------|---|
| Leadwires (standard) | Welded leadwires make a strong, reliable connection. Options include different colors, sizes, and insulating materials.   |
| Solder pads          | Lowest cost, but limits foil/resistance options.  |
| Connectors           | Insulation displacement connectors crimped onto etched leads make an economical design. Other connector types are available such as pin headers, SMT and ZIF termination. |
| Flex circuits        | Minco can supply flex circuits integrally connected with heaters.   |

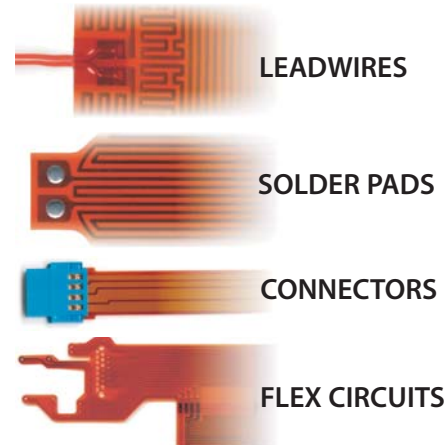

# Custom Design Options

## Integrating sensors and thermal cut-outs.







### Temperature sensors

Integrating sensors into heaters simplifies your assembly operations by providing a gradient-free system with excellent temperature control. The sensor sits in a window of the heating element. It reacts to temperature changes in the component beneath the heater, yet remains close to the heating element itself. This tight coupling of heater, sensor, and heat sink can greatly improve heating control and accuracy.

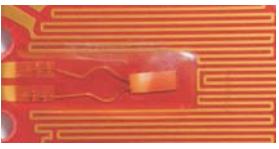
Sensors can be electrically connected via leadwires or flex circuitry.

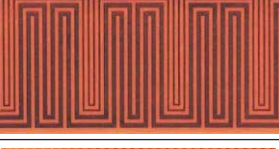
Most heater/sensors are custom designed. Minco recommends prototyping with standard heaters and Thermal-Ribbon™ sensors. Get more information on Thermal-Ribbon sensors in the "Sensors, Controllers & Accessories" section.

### Types of sensors used in heater/sensors

|   | Description  | Features  | Options   |
|---|--|---|---|
|    | <b>Surface Mount RTDs and Thermistors</b><br>Miniature sensors mounted via surface mount technology            | <ul style="list-style-type: none"> <li>• Low installed costs</li> <li>• Geared for medium to high volumes</li> <li>• Fast time response</li> <li>• Stable and accurate</li> </ul> | <ul style="list-style-type: none"> <li>• Sizes: 0805, 0603, 0402</li> <li>• RTD: 100Ω and 1KΩ platinum; ±0.06% or ± 0.12% at 0°C (DIN class A or B)</li> <li>• Thermistor: 10KΩ and 50KΩ ; ±1% at 25°C</li> </ul> |
|   | <b>Thin-film RTDs</b><br>Small ceramic elements laminated inside the heater or located on top                  | <ul style="list-style-type: none"> <li>• Highly stable and accurate</li> <li>• Standardized output</li> <li>• Low cost</li> <li>• Tight resistance tolerance</li> </ul>           | <ul style="list-style-type: none"> <li>• Platinum, 0.00385 TCR</li> <li>• 100 to 10,000 Ω</li> <li>• Wire leads or SMT</li> <li>• 0.12% or 0.06% tolerance</li> </ul>   |
|  | <b>Strip-wound RTD</b><br>Sensing wire wound around a flexible insulating strip and encapsulated inside heater | <ul style="list-style-type: none"> <li>• Can average temperatures along length of sensor.</li> <li>• Any resistance possible</li> </ul>   | <ul style="list-style-type: none"> <li>• Platinum, nickel, nickel-iron.</li> </ul>  |
|  | <b>Flat-wound RTD</b><br>Sensing wire laid in a predetermined pattern in a single plane                        | <ul style="list-style-type: none"> <li>• Fast response (0.1 sec.)</li> <li>• Can average temperatures along length of sensor.</li> </ul>  | <ul style="list-style-type: none"> <li>• Platinum, nickel, nickel-iron</li> <li>• Uniform or profiled</li> </ul>  |
|  | <b>Etched RTD</b><br>Heater and RTD etched from same temperature sensitive foil                                | <ul style="list-style-type: none"> <li>• Lowest cost</li> <li>• Fast response</li> <li>• Can average temperatures along length of sensor.</li> </ul>                              | <ul style="list-style-type: none"> <li>• Nickel or nickel-iron</li> </ul>   |
|  | <b>Thermistor</b><br>Bare or coated bead embedded in heater or placed on top and covered with epoxy            | <ul style="list-style-type: none"> <li>• High sensitivity</li> <li>• Low to moderate cost</li> </ul>  | <ul style="list-style-type: none"> <li>• NTC or PTC</li> <li>• Variety of resistances</li> <li>• Bead or SMT</li> </ul>   |
|  | <b>Thermocouple</b><br>Junction of dissimilar metals laminated inside heater                                   | <ul style="list-style-type: none"> <li>• Minimal space required</li> <li>• Rugged Construction</li> <li>• Wide temperature range</li> </ul>                                       | <ul style="list-style-type: none"> <li>• Wire or foil</li> <li>• E, J, K, or T standard</li> </ul>  |
|  | <b>Thermostat</b><br>Low cost basic heater control or thermal cutoff   | <ul style="list-style-type: none"> <li>• No external controller</li> <li>• Low system cost</li> </ul>   | <ul style="list-style-type: none"> <li>• Snap action or creep action</li> <li>• Specify setpoint</li> <li>• Wired/mounted to heater</li> <li>• See thermostat options on page 57.</li> </ul>                      |

*Specifications subject to change*

# Custom Design Options

## Value-added assemblies and complete thermal solutions.

For best heater performance and reduced installation costs, consider Minco's capabilities in mounting heaters to make complete thermal subassemblies. You can furnish the heat sinks or we can fabricate them to your specifications. Either way, you get a guaranteed bond, superior reliability, and the benefits of Minco's experience with advanced adhesives and lamination equipment. In many cases we can affix the heater to the mating part in the same step used to bond its layers together. That saves money over a two-step process.

### Vulcanized silicone rubber assemblies

Minco's proprietary vulcanization process uses no adhesive to bond heaters to mating parts. Eliminating the adhesive facilitates heat transfer, resulting in higher allowable watt densities and longer life.



### Laminated polyimide heaters

Polyimide (e.g. Kapton™) heaters can be mounted to flat or curved heat sinks using an acrylic adhesive and our specialized lamination equipment. The thin, uniform bond layer provides excellent heat transfer. Watt densities to 50 watts/in<sup>2</sup> (7.8 watts/cm<sup>2</sup>) are possible.

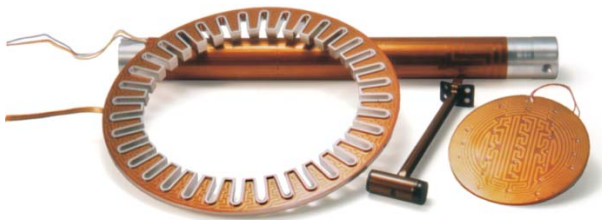

### Clamped mica heaters

Mica heaters must be secured between rigid plates to prevent separation of layers. Minco can provide many styles of mica heater assemblies: bolted, riveted or welded, flat or curved.

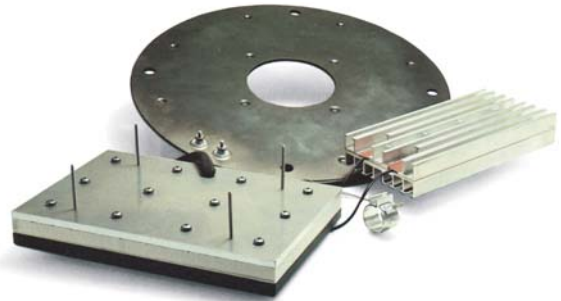

### Factory mounted All-Polyimide (AP) heaters

Factory bonded AP heaters eliminate clamping and provide optimum heat transfer to the heat sink. The excellent chemical resistance and low outgassing of AP heaters, together with Minco's precise machining capabilities, are the perfect solution for chuck heaters in semiconductor processing equipment.



### Assembly options

- Minco-supplied heat sinks: Machined, formed, and extruded parts from Minco's advanced machine shop or qualified vendors
- Coatings: PTFE coating, anodizing, or plating with nickel, copper, or gold
- Temperature sensors: Accurate and reliable temperature measurement. See the "Sensors, Controllers & Accessories" section for more information
- Thermostats and thermal cutoffs for control or limit switching
- Wire harnesses, connectors, or flex circuitry
- Electronic components
- Thermal insulation

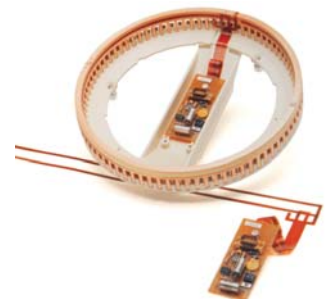



# Examples of Thermal Systems

|                                      |  |  |  |
|--------------------------------------|--|--|--|
| <b>Description of Thermal System</b> | Heat a tank containing 2 kg of chemical solution from 20°C to 50°C in 10 minutes. The space available for mounting the heater is 4" x 5" (102 x 127 mm). Input voltage is 120 VAC.       | Heat moving film in a thermal processor. A sheet of polyester film weighing 5 g must be brought from 25°C to 90°C every 2 seconds. The heater will measure 2" x 12" (51 x 305 mm) and will be mounted on a metal platen. Input voltage is 120 VAC. | An LCD heater must be capable of bringing the 6" x 8" (152 X 203 mm) display from -55°C to 0°C in 5 minutes and maintaining it there. Input voltage is 120 VDC.  |
| <b>Wattage requirements</b>          | From Thermal Calc*, we need 450 watts minimum for warmup plus losses.  | From Thermal Calc*, we need 275 watts minimum for warmup plus losses.  | From Thermal Calc*, we need 50 watts for warmup and 20 watts for maintenance of temperature.   |
| <b>Electrical parameters</b>         | $R = E^2/W = 120^2/450 = 32 \Omega$  | $R = E^2/W = 120^2/275 = 52 \Omega$  | $R = E^2/W = 28^2/50 = 16 \Omega$  |
| <b>Heater selection</b>              | Choosing polyimide for chemical resistance, the best choice is HK5490R27.7L12E   | Specifying silicone rubber for lower cost, the best choice is HR5433R44.1L12A  | From Minco's standard Thermal-Clear™ heaters we choose model H6709R14.8L12B  |
| <b>Actual wattage</b>                | Wattage is $120^2/27.7 = 520 \text{ W}$  | Wattage is $120^2/44.1 = 327 \text{ W}$  | Wattage is $28^2/14.8 = 53 \text{ W}$  |
| <b>Watt density</b>                  | Watt density = $W/\text{effective area} = 520/17.74 \text{ in}^2 = 29 \text{ W/in}^2 (4.5 \text{ W/cm}^2)$   | Watt density = $W/\text{effective area} = 327/21.80 \text{ in}^2 = 15 \text{ W/in}^2 (2.3 \text{ W/cm}^2)$   | Watt density = $W/\text{effective area} = 53/48 \text{ in}^2 = 1.1 \text{ W/in}^2 (0.2 \text{ W/cm}^2)$  |
| <b>Installation</b>                  | From watt density charts we specify Acrylic PSA with aluminum backing (E option). This is rated to 31 W/in <sup>2</sup> (4.8 W/cm <sup>2</sup> ) at 50°C.                                | Any type of heater mounting will handle the watt density. We will factory vulcanize the heater for lowest installed cost.  | We choose Acrylic PSA backing for convenience (B option). The watt density is well within the rated maximum.   |
| <b>Leadwire current</b>              | AWG 24 leadwire current rating is 7.5 A. Actual current is:<br>$I = 120/27.7 = 4.3 \text{ A (OK)}$ .   | AWG 24 leadwire current rating is 7.5 A. Actual current is:<br>$I = 120/44.1 = 2.7 \text{ A (OK)}$ .   | AWG 30 leadwire current rating is 3 A. Actual current is:<br>$I = 28/14.8 = 1.9 \text{ A (OK)}$ .  |
| <b>Control</b>                       | The CT16A controller with optional AC744 solid state relay will handle the current.  | The customer integrates a custom controller into other electronic circuits.  | A CT198-1005 Heaterstat™ will control the heater. Its setpoint will be adjustable from 6 to 62°C. We have chosen a model with a higher range in order to ensure that the LCD itself reaches 0°C. We know the setpoint will have to be higher because it controls the heater element which runs hotter than the surface beneath it. |
| <b>Sensor</b>                        | An S665 Thermal-Tab™ RTD will be mounted to the side of the tank.  | An S247 thin-film RTD will be potted into a hole in the platen. A thermostat with 100°C setpoint will provide overtemperature shutoff.   | None: The heater acts as the sensor!   |
| <b>Custom options</b>                | An AP heater would provide a higher watt density for faster warmup (at higher cost). A rubber or mica heater would allow more watts for faster warmup, if acceptable in the application. | The sensor and thermostat could be integrated into the heater.   | Placing the lead connections on an external tab would remove the lead bulge from the display area. Switching to a sensor and CT325 for control, instead of the Heaterstat, would allow higher wattage and finer control.   |

# Examples of Thermal Systems

|                               |  |   |  |
|-------------------------------|--|---|--|
| Description of Thermal System | Warm a test instrument in an avionics system from as cold as -45°C to 70°C within two minutes with ±2°C accuracy. The instrument is a cylinder 1.25" (32 mm) diameter and 3.5" (89 mm) tall, providing a heating area of 3.9 × 3.5" (100 × 89 mm). The available voltage on the aircraft is 28 VDC.            | Maintain 96 sample vials, each containing 10 ml of human blood, at 37°C. The vials are positioned in drilled blind holes in an aluminum block measuring 4.0" × 6.0" × 1.5" (102 × 152 × 38 mm) with a total mass of 500 g. The sample temperature must never exceed 40°C at 24 VDC.   | A 300 mm silicon wafer placed on a 325 mm diameter aluminum chuck must be heated from 40°C to 220°C during processing. Input voltage is 208 VAC.   |
| Wattage requirements          | From Thermal Calc*, we need 60 watts warmup power and 25 watts maintenance power.  | From Thermal Calc*, we need 60 watts for warmup and maintenance.  | From Thermal Calc*, we need 800 watts to reach the required temperature within the time limit.   |
| Electrical parameters         | $R = E^2/W = 28^2/60 = 13.1 \Omega$  | $R = E^2/W = 24^2/60 = 9.6 \Omega$  | $R = E^2/W = 208^2/800 = 54.1 \Omega$  |
| Heater selection              | Commercial and military avionics systems typically specify Polyimide insulated heaters. Model HK5482R12.1L12A is selected.   | Specifying polyimide because it is resistant to most chemicals and does not outgas, the best choice is HK5491R9.4L12B   | The required temperature exceeds the limit for polyimide heaters, and the vacuum process does not allow silicone rubber. An All-Polyimide heater, factory mounted to the chuck, is required. |
| Actual wattage                | Wattage is $28^2/12.1 = 65 \text{ W}$  | Wattage is $24^2/9.4 = 61 \text{ W}$  | Wattage is $208^2/54.1 = 800 \text{ W}$  |
| Watt density                  | Watt density = $W/\text{effective area} = 65/9.8 \text{ in}^2 = 6.6 \text{ W/in}^2 (1.0 \text{ W/cm}^2)$   | Watt density = $W/\text{effective area} = 61/21.54 \text{ in}^2 = 2.8 \text{ W/in}^2 (0.4 \text{ W/cm}^2)$  | Watt density = $W/\text{effective area} = 800/109.9 \text{ in}^2 = 7.3 \text{ W/in}^2 (1.1 \text{ W/cm}^2)$  |
| Installation                  | For this cylindrical shape heat sink, a BM3 Shrink Band is selected.   | Any type of heater mounting will handle the watt density. We recommend acrylic PSA for fast availability of prototypes.   | Factory lamination of AP heaters provides optimum heat transfer and allows operating temperatures higher than other adhesives.   |
| Leadwire current              | AWG 26 current rating is 5.0 A. Actual current is:<br>$I = 28/12.1 = 2.3 \text{ A (OK)}$ .   | AWG 24 leadwire current rating is 7.5 A. Actual current is:<br>$I = 24/9.4 = 2.6 \text{ A (OK)}$ .  | AWG 20 leadwire current rating is 13.5 A. Actual current is:<br>$I = 208/54.1 = 3.8 \text{ A (OK)}$ .  |
| Control                       | The CT325 controller will be used to control the heater.   | A custom control circuit integrated into the system electronics will control the heater. The controller is designed for a 1000 Ω platinum RTD element input.  | All electrical and motion control of the wafer processing system is centrally controlled by a computer. Thermal control is integrated into the system.                                       |
| Sensor                        | An S665 Thermal Tab RTD provides easy installation in the prototype test system.   | A 1000 Ω platinum Thermal-Tab™ RTD sensor is used. The customer tests the sensor in several positions around the aluminum block to determine the optimum location.  | An S247 thin film RTD element with high-temperature extension leads will be cemented into a hole in the platen.  |
| Custom options                | Experiments confirm the power requirements, but also show that the sensor measures only one point rather than the average temperature of the cylinder. In the final custom design an integrated Thermal-Ribbon strip sensor wraps around the circumference of the cylinder to measure the average temperature. | Testing showed that edge losses required 20% higher watt density around the periphery of the heater to equalize temperature within the block. A custom design with profiled power output, integrated sensor, and 40°C thermal fuse provides a complete thermal system in one package. | The leads exit is located at the center of the heater to fit with the design requirements of the machine.  |

\*Thermal Calc is an on-line tool available at [www.minco.com](http://www.minco.com) to assist in estimating heater wattage requirements from known parameters.

# Polyimide Thermofoil™ Heaters

Thin, flexible heating solutions from -200 to 200°C

## Overview

Polyimide (Kapton™) is a thin, semitransparent material with excellent dielectric strength. Polyimide Thermofoil™ heaters are ideal for applications with space and weight limitations, or where the heater will be exposed to vacuum, oil, or chemicals.

- Thin, lightweight heaters allow you to apply heat where it's needed, reducing operating costs
- Etched-foil heating technology provides fast and efficient thermal transfer
- Customized options (i.e. SMT components, flex leads and connectors) offer turnkey solutions to drastically reduce assembly time and increase productivity
- Custom profiling gives uniform thermal performance of the heating output to improve processing yields and productivity
- FEP internal adhesive for use to 200°C (392°F)
- UL component recognition available
- Suitable for vacuum environments (NASA-RP-1061)
- NASA approved materials for space applications (S-311-P-079)
- Resistant to most chemicals: acids and solvents
- Radiation resistant to 10<sup>6</sup> rads if built with polyimide-insulated leadwire (custom option)
- Very small sizes available
- Fluid immersible designs available (not standard)

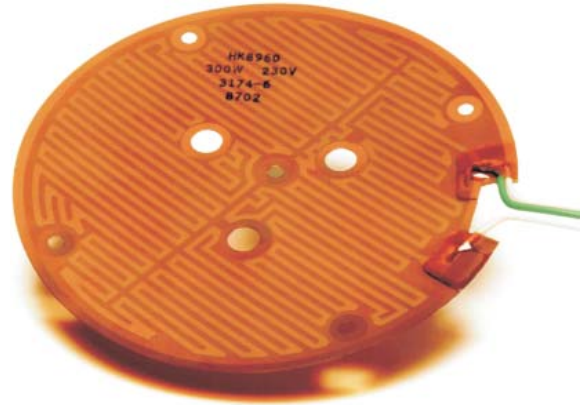

## Typical applications

- Medical diagnostic instruments and analyzers
- Maintain warmth of satellite components
- Protect aircraft electronic and mechanical devices against cold at high altitudes
- Stabilize optoelectronic components
- Test or simulate integrated circuits
- Enable cold weather operation of outdoor electronics such as card readers, LCDs or ruggedized laptops
- Maintain constant temperature in analytic test equipment

## Custom options

- Custom shapes and sizes:  
Polyimide / FEP – 22" x 42" (560 x 1065 mm)  
Polyimide / WA/ULA – 22" x 72" (560 x 1825 mm)
- Custom resistance:  
Polyimide / FEP – 450 Ω/in<sup>2</sup> (70 Ω/cm<sup>2</sup>)  
Polyimide / WA/ULA – 1500 Ω/in<sup>2</sup> (233 Ω/cm<sup>2</sup>)
- WA or ULA internal adhesive is more economical than FEP for most custom designs that operate below 150°C
- Available with surface mount sensors, connectors, heat sinks and even integral controllers
- NASA approval is available in nearly all of the standard size Polyimide heaters
- TÜV or UL recognition marking is optional
- Tighter resistance tolerance
- RoHS compliance
- Contact Access: Minco Sales and Support for design assistance

*Specifications subject to change*

# Polyimide Thermofoil™ Heaters

## Specifications

**Temperature range:** -200 to 200°C (-328 to 392°F). Upper limit with 0.003" (0.08 mm) foil backing is 150°C (302°F).

**Material:** .0002" Polyimide/0.001" FEP, (0.05/0.03 mm).

**Resistance tolerance:** ±10% or ±0.5 Ω, whichever is greater.

**Dielectric strength:** 1000 VRMS.

**Minimum bend radius:** 0.030" (0.8 mm).

**Leadwire:** Red PTFE insulated, stranded.

**Current capacity (based on 100°C max. ambient temp.):**

AWG 30 - 3.0 A

AWG 26 - 5.0 A

AWG 24 - 7.5 A

AWG 20 - 13.5 A

**Maximum heater thickness:**

**Over element** 0.012" (0.3 mm)

**Over leads**

AWG 30 (0.057 mm<sup>2</sup>) 0.050" (1.3 mm)

AWG 26 (0.141 mm<sup>2</sup>) 0.060" (1.5 mm)

AWG 24 (0.227 mm<sup>2</sup>) 0.065" (1.7 mm)

AWG 20 (0.563 mm<sup>2</sup>) 0.085" (2.2 mm)

Add 0.005" (0.1 mm) to above dimensions for foil backing.

**Dimensional tolerance:**

6" (150 mm) or less ±0.03" (±0.8 mm)

6.01 to 12" (150 to 300 mm) ±0.06" (±1.5 mm)

Over 12" (300 mm) ±0.12" (±3.0 mm)

Tighter tolerances are available on custom designs if needed.



## Flexible Heaters Prototype Design Kit

The Flexible Heaters Prototype Design Kit allows you to easily test and prototype a heating concept before starting on a journey of custom-built-to-order product.

Filled with polyimide and silicone rubber Thermofoil™ heaters, instructions and technical data, this kit will help you move towards successfully integrating flexible heaters into your application.

Model Number

TB-H1

## Polyimide/FEP Heaters Maximum Watt Density

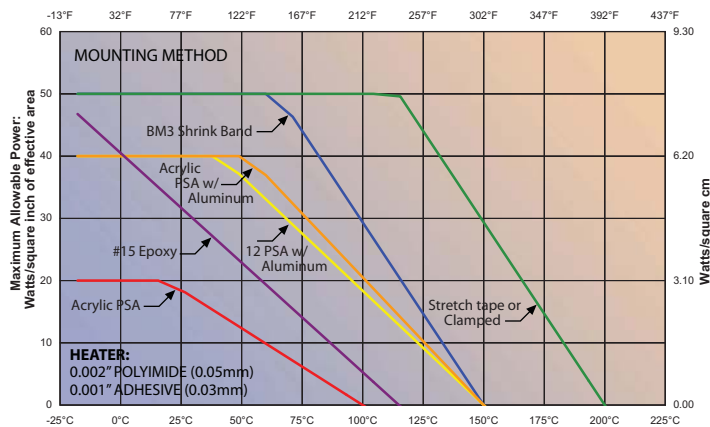

Example: At 50°C, the maximum power for a heater mounted with acrylic PSA is 18 W/in<sup>2</sup> (2.79 W/cm<sup>2</sup>).

Specifications subject to change





# Silicone Rubber Thermofoil™ Heaters

## Rugged and flexible to 235°C

### Overview

Silicone rubber is a rugged, flexible elastomer material with excellent temperature properties. It is most suited to larger heaters and industrial applications.

- Rugged construction provides high reliability in a wide range of heating applications
- Optional custom profiled heat density creates a uniform heat sink temperature which can improve processing yields
- Factory vulcanization and high temperature capability allows higher wattage levels for faster processing
- High temperature capability to 235°C (455°F)
- UL and TÜV component recognition available
- Resistant to many chemicals
- Not suitable for radiation, vacuum, or prolonged exposure to oil
- Most economical in large sizes

### Typical applications

- Thermal developing in graphic imaging equipment
- Prevent condensation in instrument cabinets
- Heat outdoor electronics
- Food service equipment
- Medical respirators
- Laminators
- Drums and other vessels
- Airplane engine heaters

### Custom options

- Custom shapes and sizes to 22" × 90" (560 × 2285 mm)
- Custom resistance to 200 Ω/in<sup>2</sup> (31 Ω/cm<sup>2</sup>)
- Minco can factory vulcanize rubber heaters to metal shapes for best economy and performance
- Heaters can have integral snaps, straps, or Velcro® for removable installation
- Heaters can include thermostats, temperature sensors and cutouts, wiring harnesses, and connectors
- RoHS compliance
- Contact Access: Minco Sales and Support for design assistance



### Specifications

**Temperature range:** -45 to 235°C (-50 to 455°F).  
With UL component recognition: -45 to 220°C (-50 to 428°F).

**Material:** Fiberglass reinforced silicone rubber, 0.008" (0.20 mm).

**Resistance tolerance:** ±10% or ±0.5 Ω, whichever is greater.

**Dielectric strength:** 1000 VRMS.

**Minimum bend radius:** 0.125" (3.2 mm).

**Leadwire:** Red PTFE insulated, stranded.

**Current capacity (based on 100°C max. ambient temp.):**

|                |                 |
|----------------|-----------------|
| AWG 30 - 3.0 A | AWG 24 - 7.5 A  |
| AWG 26 - 5.0 A | AWG 20 - 13.5 A |

**Maximum heater thickness:**

|                                 | No adhesive (A): | #12 PSA (B):    |
|---------------------------------|------------------|-----------------|
| <b>Over element</b>             | 0.020" (0.5 mm)  | 0.025" (0.6 mm) |
| <b>Over leads</b>               |                  |                 |
| AWG 30 (0.057 mm <sup>2</sup> ) | 0.070" (1.8 mm)  | 0.085" (2.2 mm) |
| AWG 26 (0.141 mm <sup>2</sup> ) | 0.080" (2.0 mm)  | 0.095" (2.4 mm) |
| AWG 24 (0.227 mm <sup>2</sup> ) | 0.090" (2.3 mm)  | 0.105" (2.7 mm) |
| AWG 20 (0.563 mm <sup>2</sup> ) | 0.120" (3.0 mm)  | 0.135" (3.4 mm) |

Add 0.005" (0.1 mm) to above dimensions for foil backing.

**Dimensional tolerance:**

|                             |                  |
|-----------------------------|------------------|
| 6" (150 mm) or less         | ±0.03" (±0.8 mm) |
| 6.01 to 12" (150 to 300 mm) | ±0.06" (±1.5 mm) |
| Over 12" (300 mm)           | ±0.12" (±3.0 mm) |

*Specifications subject to change*

# Standard Polyimide and Rubber Heaters

Minco has invested in the design time and fabrication tooling so you can jump immediately to your prototyping efforts. The following table outlines the specifications of previously designed polyimide and silicone rubber Thermofoil™ heaters.

Minco's build-to-order turnaround time is typically 3 weeks depending on quantity requirements. There is a limited available inventory of a variety of part configurations which generally allows us to meet your immediate delivery needs.

Contact Access: Minco Sales and Support to discuss mix and matching heater sizes and resistance values to help satisfy performance and lead time demands.

## Type (configuration)

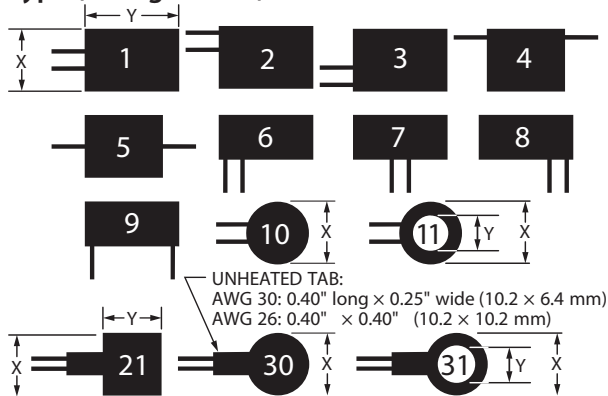

Types 21, 30, and 31 have lead connections on an external tab. The tab produces negligible heat and, in most cases, need not be adhered to the heat sink. On type 21 heaters that are 0.25" (6.4 mm) wide, the tab is the same width as the heated area.

## Specification options

Technical Specifications on pages 16 (polyimide) & 20 (rubber).

| HK                                    | Insulation:<br>HK = Polyimide<br>HR = Silicone rubber   |              |    |    |                 |               |              |                 |              |              |                  |               |              |                      |              |              |                  |              |              |
|---------------------------------------|---|--------------|----|----|-----------------|---------------|--------------|-----------------|--------------|--------------|------------------|---------------|--------------|----------------------|--------------|--------------|------------------|--------------|--------------|
| 5200                                  | Model number from tables on following pages   |              |    |    |                 |               |              |                 |              |              |                  |               |              |                      |              |              |                  |              |              |
| R17.4                                 | Heater resistance in ohms   |              |    |    |                 |               |              |                 |              |              |                  |               |              |                      |              |              |                  |              |              |
| L12                                   | Lead length in inches<br>12" (305 mm) is standard<br>Contact Minco for other lengths  |              |    |    |                 |               |              |                 |              |              |                  |               |              |                      |              |              |                  |              |              |
| A                                     | Heater backing option (see page 8)  |              |    |    |                 |               |              |                 |              |              |                  |               |              |                      |              |              |                  |              |              |
|                                       | <table border="1"> <thead> <tr> <th></th> <th>HK</th> <th>HR</th> </tr> </thead> <tbody> <tr> <td>A = No adhesive</td> <td>-200 to 200°C</td> <td>-45 to 235°C</td> </tr> <tr> <td>B = PSA backing</td> <td>-32 to 100°C</td> <td>-45 to 177°C</td> </tr> <tr> <td>D = Foil backing</td> <td>-200 to 150°C</td> <td>-45 to 235°C</td> </tr> <tr> <td>E = Foil/Acrylic PSA</td> <td>-32 to 150°C</td> <td>-32 to 150°C</td> </tr> <tr> <td>F = Foil/#12 PSA</td> <td>-73 to 150°C</td> <td>-45 to 204°C</td> </tr> </tbody> </table> |              | HK | HR | A = No adhesive | -200 to 200°C | -45 to 235°C | B = PSA backing | -32 to 100°C | -45 to 177°C | D = Foil backing | -200 to 150°C | -45 to 235°C | E = Foil/Acrylic PSA | -32 to 150°C | -32 to 150°C | F = Foil/#12 PSA | -73 to 150°C | -45 to 204°C |
|                                       | HK  | HR           |    |    |                 |               |              |                 |              |              |                  |               |              |                      |              |              |                  |              |              |
| A = No adhesive                       | -200 to 200°C   | -45 to 235°C |    |    |                 |               |              |                 |              |              |                  |               |              |                      |              |              |                  |              |              |
| B = PSA backing                       | -32 to 100°C  | -45 to 177°C |    |    |                 |               |              |                 |              |              |                  |               |              |                      |              |              |                  |              |              |
| D = Foil backing                      | -200 to 150°C   | -45 to 235°C |    |    |                 |               |              |                 |              |              |                  |               |              |                      |              |              |                  |              |              |
| E = Foil/Acrylic PSA                  | -32 to 150°C  | -32 to 150°C |    |    |                 |               |              |                 |              |              |                  |               |              |                      |              |              |                  |              |              |
| F = Foil/#12 PSA                      | -73 to 150°C  | -45 to 204°C |    |    |                 |               |              |                 |              |              |                  |               |              |                      |              |              |                  |              |              |
| U                                     | U = Marked for UL component recognition:<br>Omit for no UL marking (lower cost)<br>UL limits: 220°C for rubber heaters  |              |    |    |                 |               |              |                 |              |              |                  |               |              |                      |              |              |                  |              |              |
| HK5200R17.4L12AU = Sample part number |   |              |    |    |                 |               |              |                 |              |              |                  |               |              |                      |              |              |                  |              |              |

## Temperature sensitive elements

Heaterstats™ (page 44) require temperature sensitive heating elements, such as those found in the "NiFe" and "Ni" columns. Their resistance increases with temperature. The resistances listed are measured at 0°C (32°F).

## How to use the table of Standard Polyimide & Silicone Rubber Heaters

Overall heater size in inches. Listed in ascending order, first by dimension X, then Y. Round heaters are last.

Heater type (lead exit configuration).

Element resistance options in ohms. Select resistance to produce desired wattage with available voltage (see Ohm's law).

Effective heating area. Use this value for calculating watt density.

Available heater insulation options for this model. K=Polyimide R=rubber

| Size (in) |      | Size (mm) |       | Type | Resistance options- ohms*                      |      |      |      |     |     |      | Effective area in <sup>2</sup> (cm <sup>2</sup> ) | Lead AWG | Insulation | Model number |
|-----------|------|-----------|-------|------|--|------|------|------|-----|-----|------|---|----------|------------|--------------|
| X         | Y    | X         | Y     |      | R(0°C) [May be used with Heaterstat] → NiFe Ni |      |      |      |     |     |      |   |          |            |              |
| 0.40      | 2.60 | 10.2      | 66.0  | 1    | 123  | 62.5 | 37.8 | 18.2 |     |     | 19.1 | 0.74 (4.77)                                       | 30       | K, R       | 5215         |
| 0.41      | 4.80 | 10.4      | 121.9 | 6    | 100  | 50.1 | 30.2 | 14.5 |     |     | 15.5 | 1.40 (9.03)                                       | 26       | K, R       | 5218         |
| 0.41      | 8.30 | 10.4      | 210.8 | 5    | 61.9   | 31.1 | 18.8 | 9.1  | 6.2 | 4.3 | 9.6  | 2.50 (16.13)                                      | 26       | K, R       | 5219         |

Overall heater size in millimeters. Listed in ascending order, first by dimension X, then Y.

Temperature sensitive element resistance options (at 0°C) for use with Minco Heaterstat. Rubber (HR) models are not available with NiFe element.

Leadwire size. Maximum current capacities are listed on pages 17 and 20.

Base model number

\*Resistance tolerance is ±10% or ±0.5, whichever is greater  
Rubber (HR) models not available with NiFe element

# Wire-wound Rubber Heaters



## Overview

These silicone rubber heaters have a wire-wound element and are economical in large sizes.

- Mean time between failure (MTBF) of 100,000 hours+ provides longer heater life under continuous operation
- Rugged construction and high ductility allows repeated flexing for easier installation
- Element wires sealed inside silicone rubber protects electrical connections from moisture preventing costly downtime for field repairs
- Uniform heating to 220°C (428°F)
- Heater lengths to 90" (1.8 m)
- Mount to flat or curved surfaces
- TÜV and UL component recognition marking are standard
- 2.5, 5, 10, 15 watts/in<sup>2</sup> (0.39, 0.78, 1.55, 2.33 watts/cm<sup>2</sup>) at 120 or 240 VAC
- Lower leakage current due to capacitive coupling

## Typical applications

- Prevent condensation in motors and generators
- Protect instrument cabinets from cold and humidity
- De-icing
- Control fluid viscosity in valves and vessels
- Industrial ovens and thermal processing equipment
- Platens
- Medical devices

## Custom options

- Custom shapes and sizes to 22" × 90" (560 × 2285 mm)
- Custom resistance to 200 Ω/in<sup>2</sup> (31 Ω/cm<sup>2</sup>)
- Integral thermostats
- RoHS compliance
- Contact Access: Minco Sales and Support for custom design assistance

## Specifications

**Temperature range:** -45 to 235°C (-50 to 455°F).  
With UL component recognition: -45 to 220°C (-50 to 428°F).

**Thickness:** 0.055" ±0.005" (1.4 ±0.13 mm).  
0.250" (6.4 mm) maximum over leadwires.

**Maximum voltage rating:** UL rating is 600 VAC, TÜV recognition up to 250 VAC.

**Leadwires:** AWG 20 except where noted, PTFE insulated per UL 1199/CSA. Length on standard models is 12" (305 mm).

**Current capacity (based on 100°C max. ambient temp.):**  
AWG 20 - 13.5 A  
AWG 18 - 16.0 A

**Approvals:** All wire-wound models comply with UL Standard 499 and Canadian Standard C22.2, No. 72-M1984 and European Standard EN60335 and may bear the corresponding recognition marks.

**Wattage tolerance:** ±5%.

## Wire-wound Rubber Heaters Maximum Watt Density

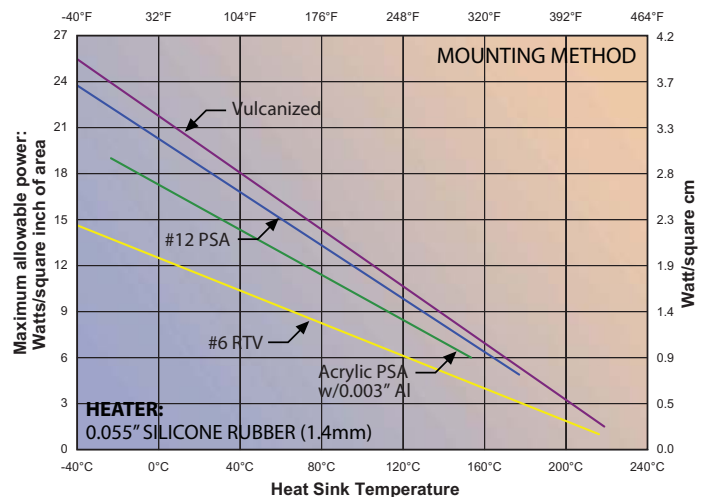

Example: At 100°C, the maximum power of a heater mounted with #6 RTV is 7 W/in<sup>2</sup> (1.09 W/cm<sup>2</sup>).

Specifications subject to change

Rubber Heaters (wire-wound)

# Mica Thermofoil™ Heaters

High watt density and temperature range

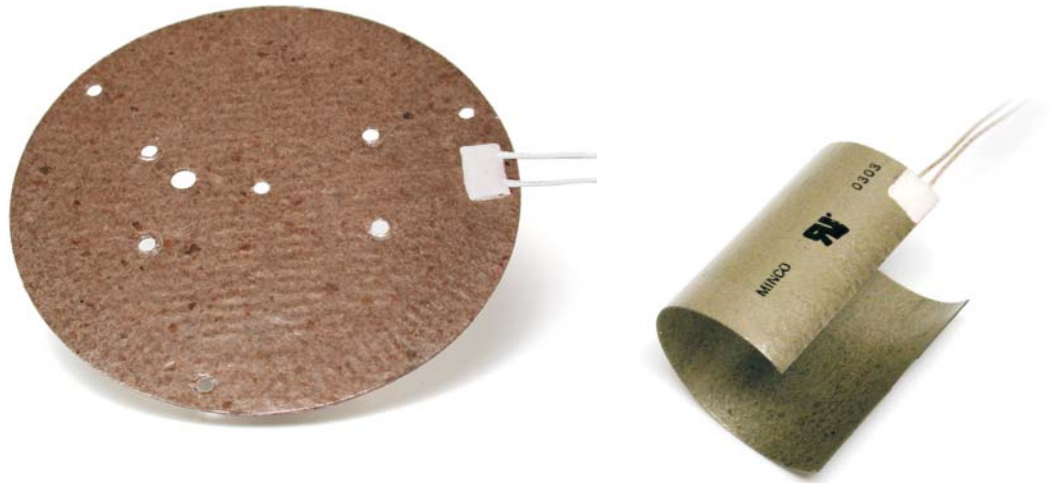

## Overview

Mica Thermofoil™ heaters consist of an etched foil element sandwiched between layers of mica. Installed by clamping to heat sinks, mica heaters provide the ultimate temperature and wattage capability for fast warmup.

- Broad temperature range of -150° to 600°C provides faster processing and cycle times for greater production output
- High watt density capability to 110 W/in<sup>2</sup> (17 W/cm<sup>2</sup>) provides faster processing times than conventional mica strip heaters
- Custom profiled heat density and mechanical clamping offers uniform heat sink temperature which can improve processing yields
- UL certification is available which can save time and money for end-use UL device recognition
- Can be factory formed to curves
- Heaters are suitable for vacuum use after initial warmup

## Typical applications

- Semiconductor processing
- Packaging, strapping, and sealing equipment
- DNA thermocycling
- Food service appliances
- Plastics and rubber molding supplemental heat

## Custom options

- Custom shapes and sizes to 22" × 46" (560 × 1168 mm)
- Custom resistance options up to 25 Ω/in<sup>2</sup> (3.9 Ω/cm<sup>2</sup>)
- Factory forming techniques offer three dimensional packaging capabilities
- Integral temperature sensors
- Contact Access: Minco Sales and Support for design assistance.



# Mica Thermofoil™ Heaters

## Specifications

**Temperature range:** -150 to 600°C (-238 to 1112°F).

Lead tab area: 538°C (1000°F) max.

**Resistance tolerance:** ±10% or ±0.5 Ω, whichever is greater.

### Dielectric strength:

0.010" (0.3mm) insulation: 1000 VRMS.

0.020" (0.5mm) insulation: 2000 VRMS (recommended for over 250 V).

**Mounting:** Must be clamped to heat sink using bolt holes provided in heater and backing plate. See the mounting diagram below. Please refer to Minco Engineering Instruction #347 for detailed installation information.

**Burn-in:** Organic binders will burn off, producing small amounts of smoke, when heaters are first powered. After this, layers can separate so heaters should not be reinstalled.

**Leadwire:** Mica/glass insulated, stranded nickel-clad copper, potted over termination with high temperature cement.

### Maximum heater thickness:

| Mica insulation | Over heater element | Over lead termination |
|-----------------|---------------------|-----------------------|
| 0.010" (0.3 mm) | 0.030" (0.8 mm)     | 0.200" (5.1 mm)       |
| 0.020" (0.5 mm) | 0.050" (1.3 mm)     | 0.220" (5.6 mm)       |

### Current capacity (based on 100°C max. ambient temp.):

AWG 22 - 8.0 A

AWG 20 - 9.0 A

AWG 18 - 11.0 A

## Installation instructions

Minco Engineering Instruction #347 describes mica heater installation in detail. Contact Minco for a copy or download the document at [www.minco.com](http://www.minco.com)

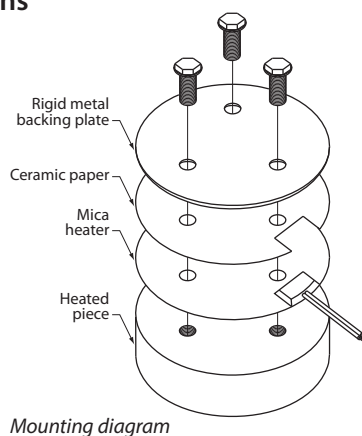

## Mica Heaters Maximum Watt Density

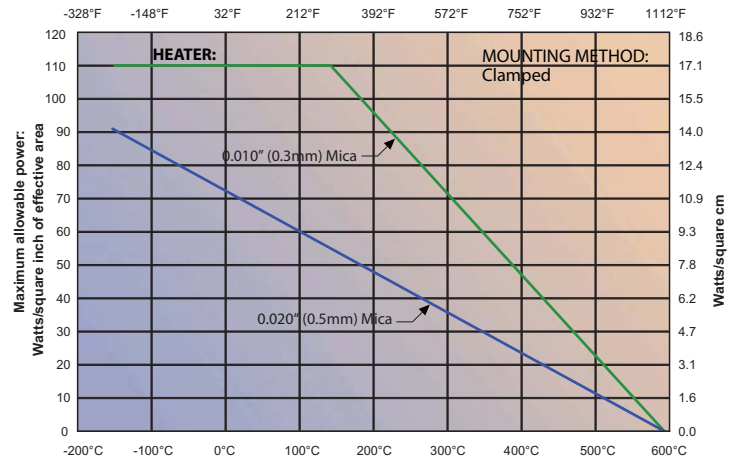

Example: At 300°C, the maximum power of a 0.010" mica heater is 70 W/in<sup>2</sup> (10.9 W/cm<sup>2</sup>).

## Backing plates

Backing plates are 0.0625" (1.6 mm) thick stainless steel with pre-drilled holes matching the bolt pattern of the specified model. These backing plates do not have cut out areas for the lead bulge and may require modification.

## How to order backing plates

Order part number AC6800 for HM6800, etc.

## Ceramic paper and mica sheets

Each mica heater is supplied with two pre-trimmed sheets of 0.125" (3.2 mm) thick ceramic fabric paper for use as a resilient pad between the heater and backing plate. This paper does not have a cut out area for the lead bulge. If the backing plate being used does not have a cut out area for the leads attachment you must use two pieces of this paper and make this cut out in each. Contact Minco to order additional ceramic paper.

## Mica sheets

Additional layers of 0.010" (0.3 mm) mica trimmed to the heater size are also available. Using an additional layer of mica will increase the dielectric strength, but it will also reduce the watt density limit by up to 50% across the temperature range. If used on the lead bulge side of the heater then the mica must be cut to allow for the ceramic and wires bulge on that side. Contact Minco to order mica sheets.

Specifications subject to change

# Thermal-Clear™ Transparent Heaters

## Overview

Featuring a micro-thin wire heating element laid in a pattern between optical grade polyester sheets, Thermal-Clear™ heaters provide reliable heat without blocking light.

- Custom heater element routing and profiling optimizes the visual clarity of the LCD and prevents “shadowing”
- Tight resistance tolerance provides constant and repeatable wattage output for longer battery life
- Low mass and high watt density offers faster warm up time needed for immediate LCD response in cold weather operation
- Rugged materials prevent costly damage during installation and handling
- Integral temperature sensors optional
- Rectangular, round, or irregular shapes
- Uniform or profiled heat patterns

## Typical applications

- Cockpit displays
- Ruggedized computers
- Portable military radios
- Handheld terminals
- Outdoor card readers
- Portable and vehicular computers
- Camera lens deicing
- Defogging windows in environmental chambers
- Heating microscope stages

## Custom options

- Integral RTD or thermistor sensors
- Flex circuit terminations
- Rigid materials
- Custom shapes and sizes to 11" × 22" (280 x 560 mm)
- RoHS compliance
- Contact Access: Minco Sales and Support for design assistance



## Thermal-Clear heaters and LCDs

Most dot matrix LCDs lose sharpness and response speed below 0°C. Achieve acceptable performance at much colder temperatures with a Minco Thermal-Clear heater. 1-2 W/in<sup>2</sup> (0.16 - 0.31 W/cm<sup>2</sup>) will keep a typical LCD operating properly in ambients as low as -55°C.

Shown below is a typical installation on a backlit LCD. The heater is sandwiched between the backlight and the LCD. We recommend a light diffuser between the heater and LCD if there is no diffusion coating on the back of the LCD. Diffusion will soften and conceal shadows cast by the heating element.

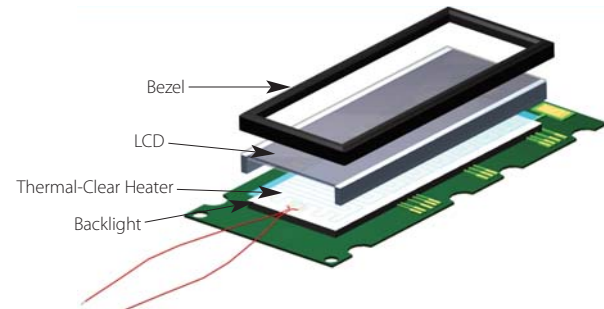

## Thermal-Clear Heaters Maximum Watt Density

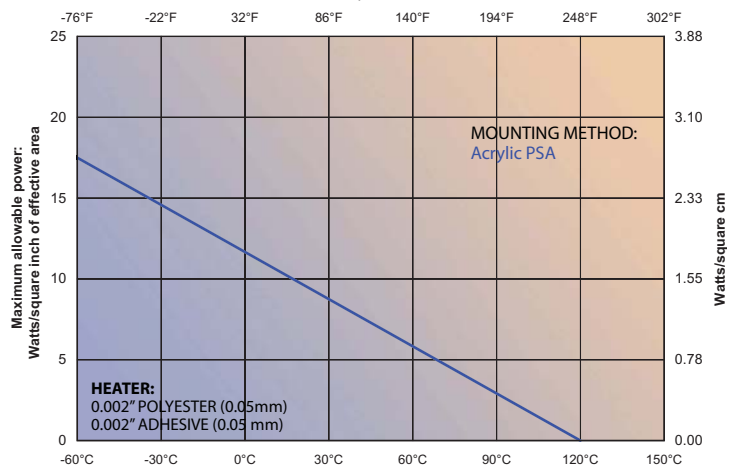

Example: At -20°C, the maximum power for a Thermal-Clear mounted with acrylic PSA is 14 W/in<sup>2</sup> (2.17 W/cm<sup>2</sup>).

Specifications subject to change



# Thermal-Clear™ Transparent Heaters

## Specifications

**Temperature range:** -55 to 120°C (-67 to 248°F).

**Insulation:** Optical grade polyester is standard. Glass and polycarbonate materials are available on custom models.

**Transparency:** 82% minimum light transmission over the visible spectrum.

**Heating element:** Resistive wire, diameter 0.0008" to 0.002" (0.02 to 0.05 mm).

**Resistance tolerance:** ±10% or ±0.5 Ω, whichever is greater.

**Leadwires:** PTFE insulated wire is standard. Lead connections are welded and anchored between heater layers for strength. Special terminations are available on custom models.

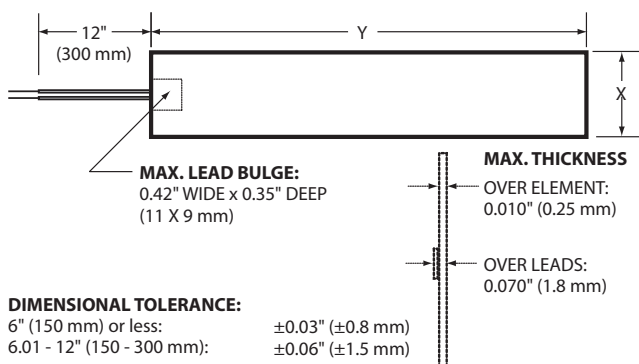

## Heaterstat™ Sensorless Temperature Controller

Any Thermal-Clear heater will work with the CT198 Heaterstat™ Sensorless Temperature Controller, which directly regulates element temperature without requiring a separate sensor. See the "Sensors and Controllers" section for full specifications and compatibility.



# All-Polyimide (AP) Heaters

Flexible heaters provide uniform heat transfer to 260°C (500°F)

## Overview

AP heaters are a high performance alternative to Minco's standard polyimide heaters, allowing higher temperatures and watt densities. Minco's unique ability to manufacture these heaters has prompted success in many high-temperature applications worldwide.

AP heaters must be factory mounted or clamped to heat sinks, and are only available as custom designs.

- Thin, lightweight heaters allow you to apply heat where it's needed ultimately reducing overall operating costs
- Etched-foil heating technology provides efficient thermal cycling of samples for increased throughput
- Low mass construction and factory lamination saves space and reduces cycle time
- Custom profiling offers uniform thermal performance of heating output for improved processing yields and productivity
- Maximum operating temperature of 260°C offers a higher temperature range than any other flexible film heater for maximum design flexibility
- Turnkey assembly solutions can drastically reduce assembly time and provide lowest total cost of operation
- Available in round, rectangular, and irregular shapes
- Power ratings to 120 W/in<sup>2</sup> (18.60 W/cm<sup>2</sup>)
- Resistant to most chemicals
- Optional built-in temperature sensors
- Contact Access: Minco Sales and Support for design assistance.



### Heater thickness:

Over element: 0.012" (0.3 mm) max.  
Over leadwire terminations: 0.150" (3.8 mm) ref.

**Dielectric strength:** 1000 VRMS at 60 Hz for 1 minute.

**Insulation resistance:** 1000 megohms min. at 500 VDC.

**Outgassing:** 0.36% total mass loss, 0.01% collected volatile condensable material, per NASA-JSC.

**Agency Approvals:** UL recognition optional.

**Maximum size:** 22" x 45" (560 x 1145 mm).  
Consult Minco for larger size options.

**Maximum resistance density:** 1500 Ω/in<sup>2</sup> (233 Ω/cm<sup>2</sup>).

## Typical applications

- Semiconductor wafer processing
- Heating of electronic components
- Packaging, fusing, and splicing equipment
- Medical diagnostic analyzers

## Specifications

**Temperature range:** -200 to 260°C (-328 to 500°F).

**With UL component recognition:**

-200 to 240°C (-328 to 464°F).

**Leadwires:** Stranded, PTFE insulated, AWG 30 to AWG 20.

## All-Polyimide Heaters Maximum Watt Density

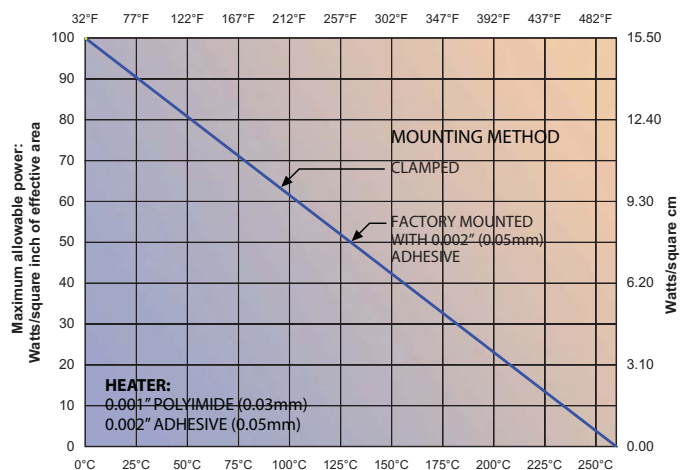

Example: At 150°C, the maximum power of a factory-mounted AP heater is 50 W/in<sup>2</sup> (7.75 W/cm<sup>2</sup>).

Specifications subject to change









# Temperature Sensors

## Fast response and easy installation



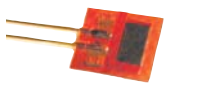

Minco is a leading manufacturer of temperature sensors. We have hundreds of common model configurations in stock for immediate shipment. Below is a selection of popular sensors for use with our heaters and controllers.

### Thermal-Ribbon™ RTDs, Thermocouples and Thermistors

Flexible Thermal-Ribbons mount easily to surfaces, alongside heaters or on top of them. All are available with PSA (pressure sensitive adhesive).

|   | Model   | Material  | Dimensions  | Temperature   |
|---|---|---|---|---|
|    | <b>S665PDY40A*</b> (100 Ω)<br><b>S665PFY40A*</b> (1000 Ω)<br><b>TS665TFY40A*</b> (50 k Ω at 25°C NTC thermistor)              | Polyimide substrate with elastomer cover, 2 or 3 PTFE leads             | 0.2" × 0.5" (5 × 12 mm)<br>Lead length: 40" (1000 mm)   | -50 to 155°C<br>-58 to 311°F<br>(except TS665 to 125°C/257°F) |
|    | <b>S667PDY40A*</b> (100 Ω)<br><b>S667PFY40A*</b> (1000 Ω)<br>(Available with 2 leads only)<br>Immersible                      | Silicone rubber substrate with elastomer cover, 2 silicone rubber leads | 0.2" × 0.6" (5 × 15 mm)<br>Lead length: 40" (1000 mm)   | -50 to 155°C<br>-58 to 311°F                                  |
|    | <b>S17624PDYT40A*</b> (100 Ω)<br><b>S17624PFYT40A*</b> (1000 Ω)<br><b>S17624PSYT40A*</b> (10,000 Ω)<br>Wide temperature range | Polyimide substrate and cover, 2 or 3 PTFE leads                        | 0.2" × 0.6" (5 × 15 mm)<br>Lead length: 40" (1000 mm)   | -50 to 200°C<br>-58 to 392°F                                  |
|   | <b>S467PDY36A*</b> (100 Ω)<br><b>S468PFY36A*</b> (1000 Ω)<br>Flexible model designed for moist environments                   | Silicone rubber body, 2 or 3 rubber leads                               | S467: 0.5" × 1.5" (13 × 38 mm)<br>S468: 0.5" × 3.0" (13 × 76 mm)<br>Lead length: 36" (900 mm) | -62 to 200°C<br>-80 to 392°F                                  |
|  | <b>S651PDY24A*</b> (100 Ω)<br>Miniature spot sensor with wire-wound RTD element   | Polyimide with foil backing<br>2 or 3 PTFE leads                        | 0.30" × 0.30" (7.6 × 7.6 mm)<br>Lead length: 24" (600 mm)                                     | -200 to 200°C<br>-328 to 392°F                                |
|  | <b>TC40JT36A*</b> (Type J)<br><b>TC40KT36A*</b> (Type K)<br><b>TC40TT36A*</b> (Type T)<br>Patch-style thermocouple            | Polyimide with PTFE leads   | 0.75" × 0.75" (19 × 19 mm)<br>Lead length: 36" (900 mm)                                       | -200 to 200°C<br>-328 to 392°F                                |

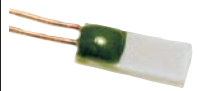
### RTD probes and elements

|   | Model  | Material   | Dimensions  | Temperature                     |
|---|--|--|---|---------------------------------|
|  | <b>S614PDY12T*</b> (100 Ω)<br><b>S614PFY12T*</b> (1000 Ω)<br><i>General purpose encased sensor</i>                                   | Stainless steel, 2 or 3 PTFE leads                       | 0.188" ø × 2" long<br>4.8 ø × 51 mm long<br>Lead length: (300mm)                                    | -269 to 260°C<br>-452 to 500°F  |
|  | <b>S853PD120Y36*</b> (100 Ω)<br><i>Tip sensitive probe</i>   | Stainless steel with copper alloy tip, 2 or 3 PTFE leads | 0.250" ø × 12" long<br>6.4 ø × 305 mm long<br>(other lengths available)<br>Lead length: 36" (900mm) | -50 to 260°C<br>-58 to 500°F    |
|  | <b>S245PD12</b> (100 ± 0.12Ω)<br><b>S245PD06</b> (100 ± 0.06Ω)<br><b>S247PF12</b> (1000 ± 0.12 Ω)<br><b>S247PF06</b> (1000 ± 0.06 Ω) | Ceramic/glass body, silver leads                         | S245: 0.08" × 0.09" (2.0 × 2.3mm)<br>S247: 0.08" × 0.20" (2.0 × 5.0mm)<br>Lead length: 0.6" (15mm)  | -70 to 400°C<br>-94 to 752°F    |
|  | <b>S270PD12</b> (100 ± 0.12Ω)<br><b>S270PD06</b> (100 ± 0.06Ω)<br><i>High temperature, high precision element</i>                    | Ceramic body, platinum leads                             | 0.047" ø × 0.59" long<br>(1.28 ø × 15mm long)<br>Lead length: 0.4" (10mm)                           | -200 to 850°C<br>-328 to 1562°F |

Note: Except where noted, all RTDs have 100 ± 0.12% Ω platinum element, TCR = 0.00385 Ω/Ω/°C (pt100 per IEC 751 Class B). Part number codes: For Thermal-Ribbons only, change the "A" to "B" for acrylic PSA backing. Change "Y" to "Z" for 3-lead model.

*Specifications subject to change*



# Temperature Controllers

## Uncontrolled system

If powered without regulation, a heater will rise in temperature until heat losses (increasing with temperature) equal heat input. This may be acceptable in rare situations, but normally is avoided because the equilibrium temperature is highly unpredictable.

In most cases the heater temperature needs to be controlled. This allows the heater to ramp up to setpoint faster without fear of overshooting and burning out the heater.

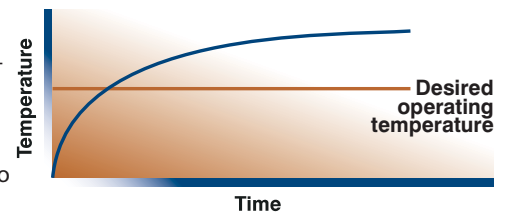

## On/off control

On/off is the most basic form of control: Full power on below setpoint, power off above setpoint. Electronic on/off controllers offer faster reaction time and tighter control than thermostats. All on/off controllers have a differential (hysteresis or dead band) between the on and off points to reduce rapid cycling and prolong switch life.

With on/off control, temperature never stabilizes but always oscillates around the setpoint.

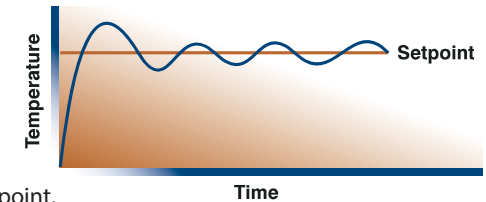

## Proportional control

A proportional controller reduces power as the heater approaches setpoint. This reduces oscillation for steadier control. Note that most controllers are “time proportioning,” where they scale power by rapid on/off switching. Short cycle times usually require a solid state relay for power switching.

Simple proportional controllers can experience “droop” where the temperature settles at a point near the setpoint but not exactly on it.

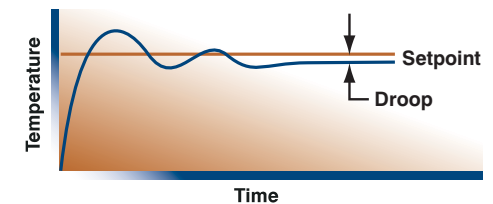

## PID controllers

Proportional/Integral/Derivative controllers solve the problem of droop and otherwise improve control accuracy through advanced digital algorithms. They have various tuning parameters for best control, but typically have some preset modes suitable for most situations.

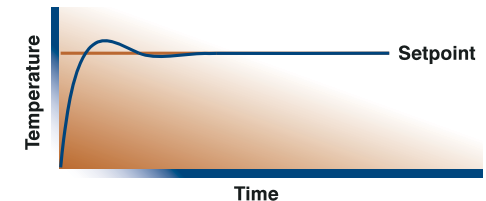

| Minco controller model | Control method                                      | Supply power                     | Sensor input  | Controlled output   |
|------------------------|---|----------------------------------|---|---|
| CT198                  | On/off  | 4.75–60 VDC                      | None (uses high-TCR heater element as sensor)   | Same as supply power  |
| CT325                  | On/off  | 4.75–60 VDC                      | PD: 100 $\Omega$ platinum RTD<br>PF: 1000 $\Omega$ platinum RTD<br>TF: 50 k $\Omega$ thermistor                           | Same as supply power  |
| CT15                   | PID, proportional, on/off (selectable)              | 100–240 VAC                      | PD: 100 $\Omega$ platinum RTD<br>PF: 1000 $\Omega$ platinum RTD<br>J, K, or T thermocouple                                | Internal SSR rated to 3.5 A at 250 VAC<br>External SSR optional |
| CT16A                  | Fuzzy Logic, PID, proportional, on/off (selectable) | 100–240 VAC (12–24 VDC optional) | PD: 100 $\Omega$ platinum RTD<br>PF: 1000 $\Omega$ platinum RTD<br>NB: 100 $\Omega$ nickel RTD<br>Most thermocouple types | Internal SSR rated to 2.0 A at 240 VAC<br>External SSR optional |

## Custom controllers

In high volume applications, a specially designed controller often gives the best performance and price. Controllers can be stand alone devices or embedded in other electronics.

## How Thermofoil heaters improve control accuracy

- Intimate thermal contact means less lag time.
- Profiling and multiple elements give more options for directing the heat where needed.
- Flexible Thermal-Ribbon™ sensors ensure tight coupling between the heater, heated object, and control sensor.
- High watt density produces nimble response.

Sensors, Controllers & Accessories



# Heaterstat™ Sensorless DC Controller

No separate sensor or thermostat required

## Overview

The Heaterstat takes temperature readings from heater models with a high temperature coefficient. You get accurate, efficient electronic control at prices comparable to thermostats.

- Use with Minco Thermal-Clear™ and select Thermofoil™ heaters
- Complete heating control system provides repeatable process control for worry-free and stable operation
- Solid state on-off control with adjustable set point offers greater durability than electro-mechanical devices
- Low power consumption — ideal for battery operated and vehicular devices
- The small PCB mount package and less wiring saves space to reduce the footprint of your device
- Mounting the Heaterstat separately allows the heater to be placed in tight spaces
- Available factory matched calibration option allows for easy plug-and-play operation

## Operation

The diagram below shows how the Heaterstat works. It periodically powers the heater just long enough to check resistance. If heater temperature is above setpoint (left side of graph), power shuts off within 0.010 seconds.

If heater temperature is below setpoint, the Heaterstat leaves power on and continually reads resistance until element temperature reaches setpoint. It then shuts off and waits until time for the next pulse.

Scan rate, the off-time between pulses, is factory set from 0.1 to 10 seconds (1 second is standard). Faster scans provide tighter control while slower scans conserve power during idle times (a 0.010 second pulse every 10 seconds takes only 0.1% of full-on power).

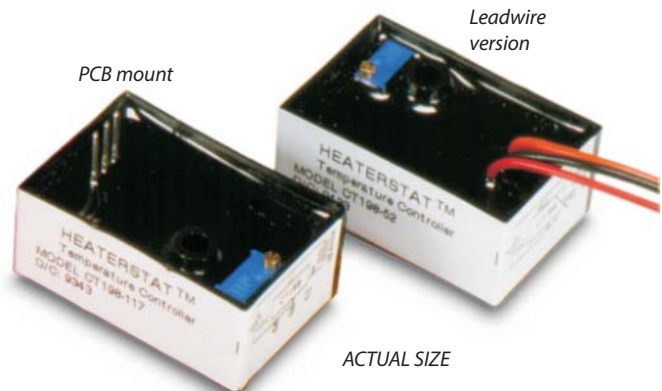
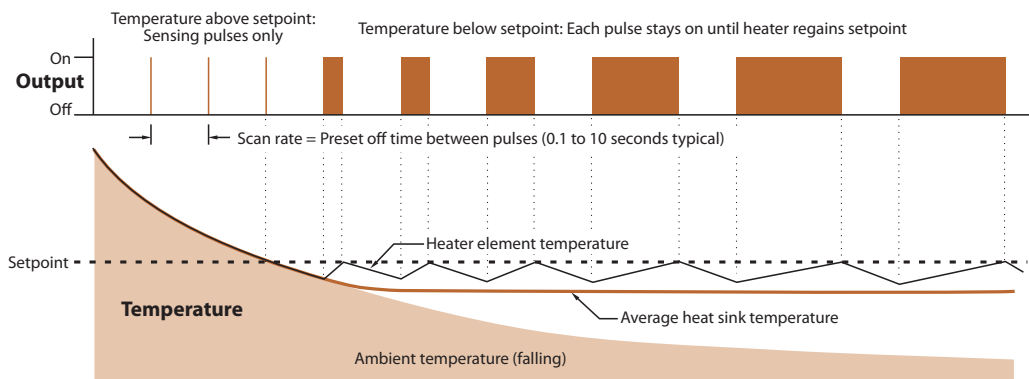

## Applications

The Heaterstat's unique design makes it the ideal companion with Minco heaters to achieve precise thermal control. Here are some application ideas and examples:

- Improve performance of LCDs or other electronics in cold storage areas.
- Replace bulky, slow-responding thermostats.
- Regulate temperature of miniature or low-mass heaters in situations where a temperature sensor is impractical or will impede response.
- Protect portable medical devices from effects of cold.
- Maintain temperature of critical circuit board components, such as crystals.
- Independently control individual sections of large area heaters, using one Heaterstat per zone.

Specifications subject to change

# Heaterstat™ Sensorless DC Controller

## Specifications

**Setpoint range:** Nominal resistance  $\pm 20\%$  min. Specify heater resistance to produce the necessary heat output in watts, given available voltage.

**Connections:** Three pins on 0.1" centers or AWG 22 wires.

**Power supply voltage:** 4.75 to 10 VDC or 7.5 to 60 VDC, depending on model. Ripple up to 10% has negligible effect; simple unregulated DC supplies are adequate for most applications.

**Nominal heater current:** 0.05 to 4 amps. See ranges below. Higher current possible with special models.

| Nominal heater current | Minimum current for proper sensing | Maximum current (1 minute) | Output ON resistance in series with heater (pin 3 to 2) | Minimum output OFF resistance |
|------------------------|------------------------------------|----------------------------|---|-------------------------------|
| 0.05 to 0.2 A          | 0.012 A                            | 0.5 A                      | 2.3 $\Omega$  | 50K $\Omega$                  |
| 0.21 to 0.5            | 0.050                              | 1.0                        | 0.8   | 50K                           |
| 0.51 to 1.5            | 0.125                              | 2.0                        | 0.5   | 50K                           |
| 1.51 to 3.0            | 0.350                              | 4.0                        | 0.3   | 50K                           |
| 2.50 to 4.0            | 1.0                                | 5.0                        | 0.25  | 50K                           |

**Scan rate (temperature above setpoint):** 1 second standard. 0.1 seconds to 10 seconds optional.

**Scan pulse width:** 10 milliseconds.

**LED indicator:** Indicates heater power on. Optional on leadwire versions.

**Calibration accuracy:**  $\pm 0.2\%$  std\*. Note that standard resistance tolerance on heaters is  $\pm 10\%$ .

**Hysteresis:** 0.05%\*.

### Setpoint drift due to:

Self-heating:  $\pm 0.2\%*$  ( $\pm 0.4\%$  for 1.5 to 4 A range).

Ambient temperature:  $\pm 0.02\%/^{\circ}\text{C}$ \* ( $\pm 0.06\%/^{\circ}\text{C}$  for 1.5 to 4 A range).

Supply voltage change:  $\pm 0.03\%/ \text{volt}$ \*.

**Supply voltage ripple effects:** Negligible, assuming 50/60Hz, 10% max. ripple.

### Controller supply current:

Output ON: 3 mA max.

Output OFF: 2 mA max; 1 mA typical at 10 VDC.

### Ambient temperature:

Operating:  $-40$  to  $70^{\circ}\text{C}$  ( $-40$  to  $158^{\circ}\text{F}$ ).

Storage:  $-55$  to  $85^{\circ}\text{C}$  ( $-67$  to  $185^{\circ}\text{F}$ ).

**Relative humidity:** 90% max.

**Physical:** Epoxy sealed for moisture resistance. Will withstand wave soldering and water/detergent wash; contact Minco before cleaning with other chemicals.

**Weight:** 1 ounce (28 g).

**Mounting:** Mounting hole for #6 screw through, or #8 thread forming screw.

**Heater:** Wire-wound or etched-foil heater with high temperature coefficient of resistance (TCR).

| Heater element                  | TCR ( $\Omega/\Omega/^{\circ}\text{C}$ ) |
|---------------------------------|--|
| Copper foil or wire (Cu)        | 0.00427                                  |
| Nickel foil (Ni)                | 0.00536                                  |
| Nickel wire (Ni)                | 0.00672                                  |
| Nickel-iron foil or wire (NiFe) | 0.00519                                  |

\* To convert resistance deviations to temperature:

$$\Delta T = \% \text{ deviation} \left( T + \frac{1}{TCR} \right)$$

Where:

TCR = Temperature coefficient of resistance ( $\Omega/\Omega/^{\circ}\text{C}$ )

T = Setpoint temperature ( $^{\circ}\text{C}$ )

$\Delta T$  = Temperature deviation ( $^{\circ}\text{C}$ )

For example, assume a Heaterstat setpoint of  $50^{\circ}\text{C}$ , and heater TCR of  $0.00536 \Omega/\Omega/^{\circ}\text{C}$  (nickel foil). Calibration accuracy is  $\pm 0.2\%$  of nominal resistance which translates to temperature as:

$$\Delta T = \pm 0.2\% \left( 50^{\circ}\text{C} + \frac{1}{0.00536} \right) = \pm 0.47^{\circ}\text{C}$$

# Heaterstat™ Sensorless DC Controller

## Standard models

One second scan rate.

6" (150 mm) leadwires.

LED power indicator.

Calibration: Setpoint factory-calibrated to specified resistance.

| Model Number | Setpoint range ( $\Omega$ ) |         | Supply voltage (VDC) |         |
|--------------|-----------------------------|---------|----------------------|---------|
|              | Minimum                     | Maximum | Minimum              | Maximum |
| CT198-1000   | 4.50                        | 6.75    | 4.75                 | 10      |
| CT198-1001   | 5.63                        | 8.44    | 7.5                  | 16      |
| CT198-1002   | 7.03                        | 10.55   | 7.5                  | 21      |
| CT198-1003   | 8.79                        | 13.18   | 7.5                  | 26      |
| CT198-1004   | 10.99                       | 16.48   | 7.5                  | 33      |
| CT198-1005   | 13.73                       | 20.60   | 7.5                  | 41      |
| CT198-1006   | 17.17                       | 25.75   | 7.5                  | 60      |
| CT198-1007   | 21.46                       | 32.19   | 7.5                  | 60      |
| CT198-1008   | 26.82                       | 40.23   | 7.5                  | 60      |
| CT198-1009   | 33.53                       | 50.29   | 7.5                  | 60      |
| CT198-1010   | 41.91                       | 62.86   | 7.5                  | 60      |
| CT198-1011   | 52.39                       | 78.58   | 7.5                  | 60      |
| CT198-1012   | 65.48                       | 98.23   | 7.5                  | 60      |
| CT198-1013   | 81.85                       | 122.78  | 7.5                  | 60      |
| CT198-1014   | 102.32                      | 153.48  | 7.5                  | 60      |
| CT198-1015   | 127.90                      | 191.85  | 7.5                  | 60      |
| CT198-1016   | 159.87                      | 239.81  | 7.5                  | 60      |
| CT198-1017   | 199.84                      | 299.76  | 7.5                  | 60      |
| CT198-1018   | 249.80                      | 374.70  | 7.5                  | 60      |
| CT198-1019   | 312.25                      | 468.38  | 7.5                  | 60      |
| CT198-1020   | 390.31                      | 585.47  | 7.5                  | 60      |
| CT198-1021   | 487.89                      | 731.84  | 9                    | 60      |
| CT198-1022   | 609.86                      | 914.80  | 11                   | 60      |

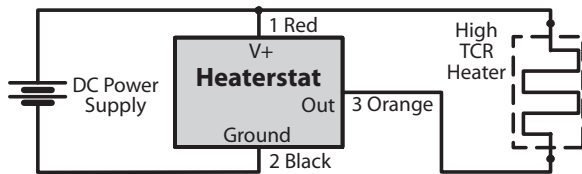

Wiring diagram

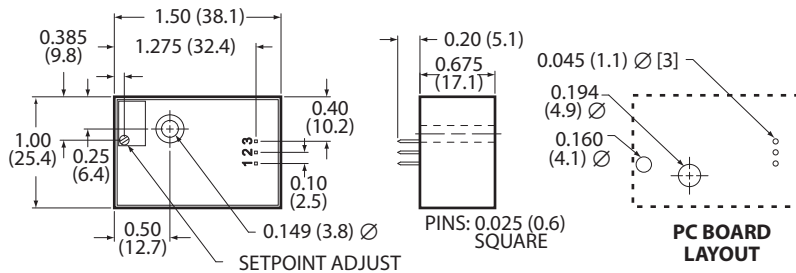

Dimensions in inches (mm)

## Specification options

|                                       |  |
|---------------------------------------|--|
| CT198-1019                            | <b>Model number</b><br>CT198 = Heaterstat (nominal setpoint)<br>CT698 = Heaterstat matched to heater   |
| R                                     | <b>Setpoint calibration code</b><br>R = Nominal heater resistance (CT198)<br>T = Heaterstat/heater matched set (CT698)   |
| 365                                   | <b>Initial calibration setpoint</b><br>Setpoint calibration code = R:<br>Nominal heater resistance at set point temperature (in ohms). * Must be within allowable range for specified model.<br>Setpoint calibration code = T:<br>Temperature setpoint. Specify temperature and scale ( $^{\circ}\text{C}$ or $^{\circ}\text{F}$ )<br>Ex: 120F represents 120 $^{\circ}\text{F}$ |
| L                                     | <b>Leads</b><br>L = Leadwires (standard)<br>P = Pins (LED not available)   |
| 1                                     | <b>Scan rate</b><br>0.1 to 10 seconds (1 second standard)  |
| CT198-1019R365L1 = Sample part number |  |

\* To determine heater resistance at temperature T, go to [www.minco.com/ct198.html](http://www.minco.com/ct198.html)

Resistance vs. temperature tables are available at: [www.minco.com/sensorcalc/](http://www.minco.com/sensorcalc/)

# Heaterstat™ Sensorless DC Controller

## Design considerations

Minco will be pleased to provide assistance with any of the design steps below.

**Heater:** A heater intended for use with a Heaterstat must have a temperature-sensitive element. All Thermal-Clear heaters meet this requirement, as do heaters with NiFe or Ni foil.

**Installation:** The Heaterstat is small enough to mount directly to printed circuit boards and will withstand both wave soldering and water wash. Secure it to the board through the mounting hole. If you intend to adjust the setpoint after installation you will need a hole in the board opposite the setpoint trimmer. The leadwire version does not require a circuit board.

**System accuracy:** The Heaterstat, by its design, controls the temperature of the heater instead of the heat sink. The heater's element always runs hotter than the surface to which it is mounted. For best accuracy under changing ambient conditions, your design should attempt to either reduce this gradient or stabilize it to a predictable level. Some suggestions are:

- Use the proper amount of heat. Try to size the heater to run at least 50% of the time in normal operation and at no more than 5 W/in<sup>2</sup> (0.78 W/cm<sup>2</sup>).
- Maximize contact between the heater and heat sink.
- Stabilize the system. Maintain a fairly constant supply voltage and insulate the assembly from changes in ambient temperature.
- Specify standard 1-second scan rate or faster.
- Consider the CT325 miniature DC controller

**Setpoint calibration:** A Heaterstat is factory calibrated to the nominal resistance of the heater at the setpoint temperature. Standard heaters, however, have a resistance tolerance of ±10%, or >25°C. For best results we recommend you recalibrate your Heaterstat after installation. Simply adjust the setpoint until temperature settles at the desired value as verified by a digital thermometer such as the Minco TI142.

Where recalibration is impractical you can improve accuracy by ordering Heaterstats and heaters in matched sets. Minco can compensate for heater tolerance by calibrating the controller to the actual measured resistance of its mating heater rather than to the nominal resistance. The heater and controller will be marked with matching serial numbers. When ordering a Heaterstat for a matched set, specify model CT698 instead of CT198.

## Evaluation kits

Test the concept and performance of Heaterstats before investing in a custom design. Each includes a controller and matching heater. You just supply electric power.

### Evaluation kit #4

Contains H15227 Thermal-Clear transparent heater and CT198-4. **Order CT198-K4.**

**Setpoint:** Adjustable from -40 to 95°C.

**Voltage:** 4.75 to 10 VDC.  
5 VDC nominal.

**Watts:** 1.7 W at  
5 VDC and 50°C.

**Heater dimensions:** 0.75" × 4" (19 × 102 mm).

**Scan rate:** 10 seconds; LED indicator.



### Evaluation kit #2

Contains HK15228 polyimide Thermofoil heater and CT198-2. **Order CT198-K2.**

**Setpoint:** Adjustable from 0 to 120°C.

**Voltage:** 7.5 to 38 VDC.  
24 VDC nominal.

**Watts:** 40 W at  
24 VDC and 80°C.

**Heater dimensions:**  
2" × 4" (51 × 102 mm).

**Scan rate:** 1 second; LED indicator.



## Miniature Heaterstat controllers

Minco can furnish SIP or DIP packages using remote digital setpoint adjustment.





# CT325 Miniature DC Temperature Controller

Tight control in a small package

## Overview

The CT325 Miniature DC Temperature Controller is designed for use with Minco Thermofoil™ heaters and RTD or thermistor sensors. It offers inexpensive on/off temperature control of your process or equipment with accuracy many times better than bimetal thermostats. Easily read and adjust the set point temperature using a voltmeter, then monitor the actual signal temperature at the other end. Operating from your 4.75 to 60 volt DC power supply, the controller can switch up to 4 amps power to the heater. A bright LED indicates when power is applied to the heater.

The entire unit is epoxy filled for moisture resistance, with a through-hole for a mounting bolt. A terminal block provides the power input, sensor input and heater output connections.

- Tight control in a small package means that enclosures or panel spaces are not required which allows successful portable device implementation
- Simple control without complicated programming can reduce set-up time
- Three-wire RTD connection cancels lead resistance for highly accurate temperature readings
- Solid state on-off control with adjustable set point improves durability compared to electro-mechanical devices
- Flexible heating control compliments all Minco Thermofoil™ Heaters for convenient off-the-shelf operation
- Uses standard 100 Ω or 1000 Ω platinum RTDs or 50 kΩ thermistor sensor input
- Single DC power source provides power to the controller and heater up to 240 watts

## Applications

- IV solutions for medical/surgical applications
- Military batteries
- Enclosures to maintain the temperature of electronics
- Ruggedized laptop LCDs and hardrives

## Custom design options

Minco can customize the design of the CT325 for special applications. Specific temperature ranges, other sensor options, and special packaging are possible for volume OEM applications.



CT325 DC Controller

## Specifications

**Input:** 100 Ω or 1000 Ω platinum RTD, 0.00385 Ω/Ω/°C, 2 or 3-leads, or 50 kΩ NTC thermistor, 2-lead.

**Setpoint range:** 2 to 200°C (36 to 392°F) for platinum RTD input. 25 to 75°C (77 to 167°F) for thermistor input. Consult factory for other ranges.

**Setpoint stability:** ±0.02% of span/°C.

**V<sub>temp</sub> signal:** 0.010 V/°C over specified range.

| Platinum RTD sensor |               | Thermistor sensor |             |
|---------------------|---------------|-------------------|-------------|
| 2°C                 | 0.02 V        | 25°C              | 0.25 V      |
| 50°C                | 0.50 V        | 50°C              | 0.50 V      |
| 100°C               | 1.00 V        | 75°C              | 0.75 V      |
| 200°C               | 2.00 V        |                   |             |
| Accuracy:           | ±1% of span   | Accuracy:         | ±2% of span |
| Linearity:          | ±0.1% of span | Linearity:        | ±2% of span |

**Deadband:** ±0.1°C (0.2°F).

**Input power:** 4.75 to 60 VDC.

**Output:** Open drain, 4 amps max. DC.

**Leadwire compensation:** (3-wire RTD) ±0.06°C/Ω for 100 Ω or 1000 Ω platinum up to 25 Ω per leg.

**Fault protection:** Heater disabled on RTD short or thermistor open. No heater protection; external fuse is recommended.

**Operating ambient temperature range:** -40 to 70°C (-40 to 158°F).

**Relative humidity:** 0 to 95% non-condensing.

**Physical:** Polycarbonate case, epoxy sealed for moisture resistance.

**Weight:** 1 oz. (28g).

**Connections:** Terminal block for wires AWG 22 to AWG 14.

**Mounting:** Mounting hole for #6 screw through or #8 thread forming screw.

*Specifications subject to change*

# CT325 Miniature DC Temperature Controller

## Specification options

|                                 |   |
|---------------------------------|---|
| CT325                           | Model number  |
| PD                              | Sensor type from table below  |
| 1                               | Power supply:<br>1 = 4.75 to 10 VDC<br>2 = 7.5 to 60 VDC                            |
| C                               | Temperature range:<br>A = 25 to 75°C (thermistor only)<br>C = 2 to 200°C (RTD only) |
| 1                               | Dead band:<br>1 = 0.1°C   |
| CT325PD1C1 = Sample part number |   |

| Sensor type         | Code |
|---------------------|------|
| 100 Ω platinum RTD  | PD   |
| 1000 Ω platinum RTD | PF   |
| 50 kΩ thermistor    | TF   |

Note: Sensors often used with the CT325 are found at the beginning of this section.

## Dimensions in inches (mm)

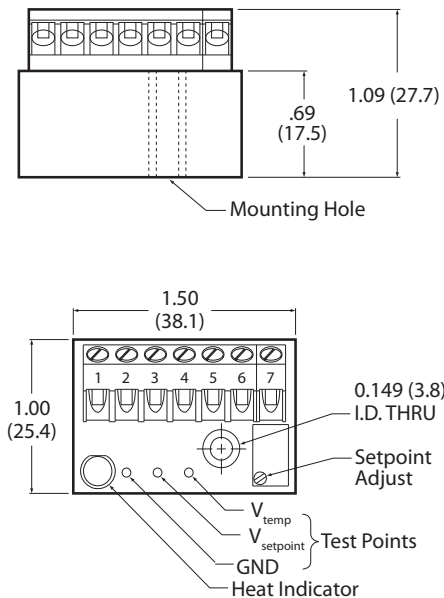

## Wiring diagrams

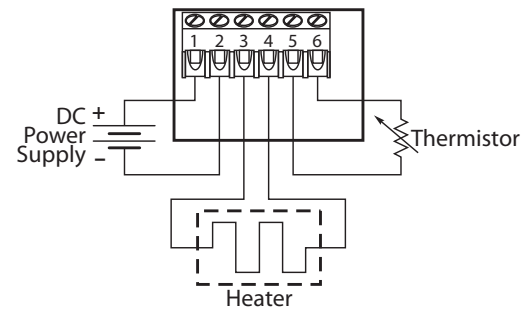
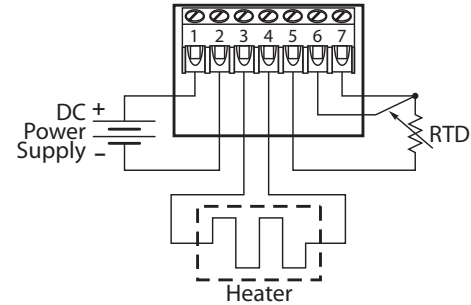

## AC powered heaters

The CT325 can provide the control signal to an external solid state relay to switch AC power. Use 15 VDC as the control voltage.

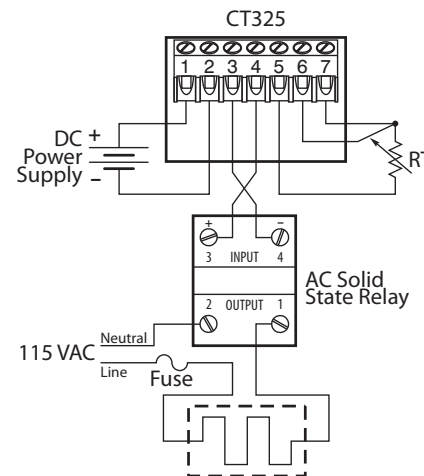

# CT15 Temperature Controller & Alarm

Compact 1/16 DIN size



CT15 Controller

## Overview

The CT15 is an easy to use controller with sophisticated PID control. It can also be a single or 2-stage alarm (using alarm feature plus control relay) to monitor motors and generators for overheating.

- RTD or thermocouple input
- Control modes: Self-Tune, pre-set or programmable PID, or On/Off
- Bright red LED display
- Ramp to setpoint
- Digital sensor input correction
- Digital input filter adjustable for noisy or jittery processes
- Four security levels
- Setpoint limits
- Non-volatile memory needs no battery backup
- Input fault timer
- Alarms at one or two temperatures
- Alarm Relay option is programmable for high, low, absolute, or deviation. Relay can be reset manually or automatically and controls a single electromechanical relay with voltage-free contacts

## Specifications

### Selectable inputs:

RTD: 2 or 3-wire, Minco types PD or PE (100  $\Omega$  EN60751 platinum).  
Thermocouple: Type J (factory default), K, T (selectable).

### Input impedance:

Thermocouple: 3 megohms minimum.  
RTD current: 200  $\mu$ A maximum.

**Sensor break or short protection:** De-energizes control outputs to protect system.

**Loop break protection:** Error message is initiated and output is turned off in case of shorted sensor or open heater circuit. Break time adjustable from OFF to 99 minutes.

**Cycle rate:** 1 to 80 seconds.

**Setpoint range:** Selectable from -212 to 1371°C (-350 to 2500°F), input dependent.

**Display:** One 4 digit, 7 segment, 0.3" high LED. Display shows the measured temperature unless a control key is pressed, then it will display the item value.

**Control action:** Reverse (usually heating) or Direct (usually cooling), selectable.

**Ramp/Soak:** One ramp, 0 to 100 hours.

*Specifications subject to change*

# CT15 Temperature Controller & Alarm

## Specifications continued

**Accuracy:**  $\pm 0.25\%$  of span  $\pm 1$  count.

**Resolution:**  $1^\circ$  or  $0.1^\circ$ , selectable.

**Line voltage stability:**  $\pm 0.05\%$  over supply voltage range.

**Temperature stability:**  $4 \mu V/^\circ C$  ( $2.3 \mu V/^\circ F$ ) typical,  $8 \mu V/^\circ C$  ( $4.5 \mu V/^\circ F$ ) max. ( $100 \text{ ppm}/^\circ C$  typical,  $200 \text{ ppm}/^\circ C$  max.).

**Isolation:** Relay and SSR outputs are isolated. Pulsed voltage output must not share a common ground with the input.

**Supply voltage:** 100 to 240 VAC nom.,  $+10\%$ - $15\%$ , 50 to 400 Hz, single phase; 132 to 240 VDC, nom.,  $+10\%$ - $20\%$ . 5 VA maximum.

*Note:* Do not confuse controller power with heater power. The controller does not supply power to the heater, but only acts as a switch. For example, the controller could be powered by 115 VAC, but controlling 12 VDC to the heater.

**Operating temperature range:**  $-10$  to  $55^\circ C$  ( $14$  to  $131^\circ F$ ).

**Memory backup:** Non-volatile memory (no batteries required).

### Control output ratings:

AC SSR (SPST): 3.5 A @ 250 VAC @  $25^\circ C$  ( $77^\circ F$ ); derates to 1.25 A @  $55^\circ C$  ( $130^\circ F$ ).

An SSR is recommended for longer life than a mechanical relay.

Mechanical relay, SPST Form A (Normally Open):

3 A resistive, 1.5 A inductive @ 250 VAC;  
pilot duty: 250 VAC; 2 A @ 125 VAC or  
1 A @ 250 VAC.

Switched voltage (non-isolated):

5 VDC @ 25 mA.

Alarm relay, SPST Form A (Normally Open):

3 A resistive, 1.5 A inductive @ 250 VAC;  
pilot duty: 250 VAC; 2 A @ 125 VAC or  
1 A @ 250 VAC.

**Weight:** 227g (8 oz.).

**Agency approvals:** UL & CSA.

**Front panel rating:** Type 4X (IP66).

## Specification options

| CT15                         | Model number  |
|------------------------------|---|
| 1                            | Alarm:<br>0 = No<br>1 = Yes   |
| 2                            | Input:<br>1 = J, K, or T thermocouple<br>2 = $100 \Omega$ platinum RTD, type PD or PE |
| 1                            | Output:<br>1 = Built-in AC SSR<br>2 = Pulsed voltage (5 VDC)<br>3 = Mechanical relay  |
| CT15121 = Sample part number |   |

## Dimensions shown in inches (mm)

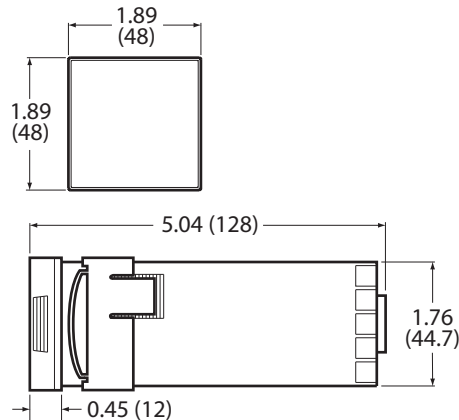

PANEL CUTOUT: 1.775"  $\times$  1.775" (45 mm  $\times$  45 mm)  
MAXIMUM PANEL THICKNESS: 0.25" (6.35 mm)

Note: See page 54 for controller accessories

# CT16A Temperature Controller

Compact 1/16 DIN size



CT16A Controller

## Overview

This economical controller packs sophisticated PID control into a compact 1/16 DIN enclosure. A wide range of control modes, sensor input types, and relay or SSR outputs give versatile control of Thermofoil™ heaters and lets you easily connect to other electronics.

- Dual displays continuously show the set point and the actual temperature reading in resolutions of 1°, 0.1°, or engineering units
- Universal Input fits any sensor: Select from 10 thermocouple types, 4 RTD types, voltage, and current signals
- Isolated Outputs for safe, easy wiring
- Loop Break protection handles sensor or heater failure
- Peak / Valley records the maximum and minimum temperatures
- Front panel is waterproof and corrosion-resistant, making it ideal for sanitary applications. Illuminated keypad for easy operation
- Limit the temperatures which the operator can set via four password-protected Security Levels
- Controller can Self-Tune for best PID control
- Control modes: Self-Tune, pre-set or adjustable PID values, simple On/Off control, and open loop
- Fuzzy Logic provides better response time and reduces overshoot in processes with unpredictable inputs
- Alarms at one or two temperatures
- Alarm Relay option is programmable for high, low, absolute, or deviation, can be reset manually or automatically, and controls a single electromechanical relay with voltage-free contacts
- Ramp & Soak option handles complex heating profiles of 16 segments with front-panel activation and a selectable time base (CT16A3)
- Auto / Manual option easily switches to manual control for set up or experiments (CT16A3)
- RS-232 or RS-485 Serial Communications access the temperature readings and all control parameters (optional)
- Retransmit either the sensed temperature or the set point as a voltage or current signal to a computer or recorder (optional)
- Vary the Set Point using a potentiometer, a voltage, or a current signal (optional)
- 4-Stage Set Point to quickly switch from one temperature to the next (optional)

*Specifications subject to change*



# CT16A Temperature Controller

## Specifications

### Selectable inputs:

RTD: 2 or 3-wire, Minco types

- PD or PE (100 Ω EN60751 platinum),
- PA (100 Ω NIST platinum),
- PF (1000 Ω EN60751 platinum), or
- NA (120 Ω Nickel).

Thermocouple: Type J (factory default), K, T, L, E, R, S, B, C, or N.

DC current: 0-20 mA or 4-20 mA (use with Temptran™ transmitters).

DC voltage: 0-10 or 2-10 VDC, -10 to 10 mVDC, scalable.

### Input impedance:

Voltage: 5000 Ω.

Thermocouple: 3 megohms minimum.

Current: 10 Ω.

RTD current: 200 μA.

### Sensor break or short protection:

Selectable output: disabled, average output before fault, or preprogrammed output.

Adjustable delay: 0.0 to 540.0 minutes.

**Loop break protection:** Error message is initiated and output is turned off in case of shorted sensor or open heater circuit.

Break time adjustable from OFF to 9999 seconds.

**Cycle rate:** 1 to 80 seconds.

**Setpoint range:** Selectable from -212 to 2320°C (-350 to 4208°F), input dependent.

**Displays:** Two, 4 digit, 7 segment, 0.3" high LEDs. Process Value red, Setpoint Value green. °C or °F.

**Control action:** Reverse (usually heating) or Direct (usually cooling), selectable.

**Ramp/soak:** (CT16A3 only) 16 separate ramp and soak times are adjustable in minutes or seconds from 0 to 9999. When the program has ended, you may choose to repeat, hold, revert to local setpoint, or turn the outputs off.

**Accuracy:** ±0.25% of span ±1 count.

**Resolution:** 1° or 0.1°, selectable.

**Line voltage stability:** ±0.05% over supply voltage range.

**Temperature stability:** 4 μV/°C (2.3 μV/°F) typical, 8 μV/°C (4.5 μV/°F) max. (100 ppm/°C typical, 200 ppm/°C max.).

### Isolation:

Relay and SSR: 1500 VAC to all other inputs and outputs.

SP1 and SP2 current and voltage: 500 VAC to all other inputs and outputs, but not isolated from each other.

Process output (options 934, 936): 500 VAC to all other inputs and outputs.

**Supply voltage:** 100 to 240 VAC nom., +10/-15%, 50 to 400 Hz, single phase; 132 to 240 VDC, nom., +10/-20%. 5 VA maximum. 12 & 24 volt AC/DC optional.

*Note:* Do not confuse controller power with heater power. The controller does not supply power to the heater, but only acts as a switch. For example, the controller could be powered by 115 VAC, but controlling 12 VDC to the heater.

**Operating temperature range:** -10 to 55°C (14 to 131°F).

**Memory backup:** Non-volatile memory (no batteries required).

### Control output ratings:

AC SSR (SPST): 2.0 A combined outputs

- A & B @ 240 VAC @ 25°C (77°F);
- derates to 1.0 A @ 55°C (130°F).

An SSR is recommended for longer life than a mechanical relay.

Mechanical relay, SPST Form A (Normally Open) or Form B (Normally Closed):

- 3 A resistive, 1.5 A inductive @ 240 VAC;
- pilot duty: 240 VAC; 2 A @ 120 VAC or 1 A @ 240 VAC.

Switched voltage (isolated): 15 VDC @ 20 mA.

Proportional current (isolated): 0 to 20 mA, 600 Ω max.

DC SSR: 1.75 A @ 32 VDC max.

Alarm relay, SPST Form A (Normally Open):

- 3 A @ 240 VAC resistive;
- 1/10 HP @ 120 VAC.

## Specification options

| CT16A                              | Model number  |
|------------------------------------|---|
| 2                                  | Feature set:<br>2 = Standard<br>3 = Enhanced (ramp & soak, Auto/manual)   |
| 1                                  | Alarm relay:<br>0 = No<br>1 = Yes   |
| 1                                  | Output A:<br>1 = Built-in AC SSR<br>2 = Pulsed voltage (15 VDC) for external SSR<br>3 = Mechanical relay, SPST (normally open)<br>4 = Mechanical relay, SPST (normally closed)<br>5 = Current<br>8 = DC SSR             |
| 0                                  | Output B:<br>0 = None<br>1 = Built-in AC SSR<br>2 = Pulsed voltage (15 VDC) for external SSR<br>3 = Mechanical relay, SPST (normally open)<br>4 = Mechanical relay, SPST (normally closed)<br>5 = Current<br>8 = DC SSR |
| -948                               | Options (leave blank for none)  |
| CT16A2110-948 = Sample part number |   |

*Specifications subject to change*

# CT16A Temperature Controller

## Dimensions shown in inches (mm)

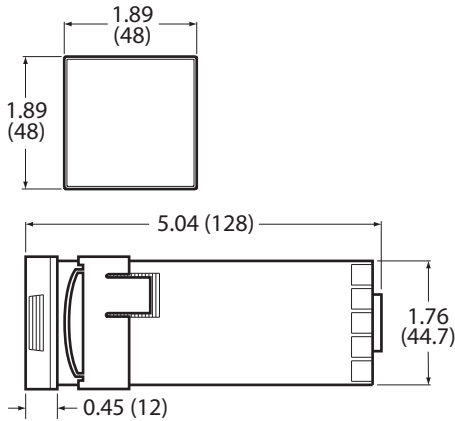

PANEL CUTOUT: 1.775" × 1.775" (45 mm × 45 mm)  
MAXIMUM PANEL THICKNESS: 0.25" (6.35 mm)

## Additional options for CT16A (board level)

**924: Analog remote setpoint:** (0 to 10 VDC) Vary the setpoint using a voltage signal.

**926: Analog remote setpoint:** (4 to 20 mA DC) Vary the setpoint using a current signal.

**928: Analog remote setpoint:** (0 to 10,000 Ω) Vary the setpoint using a potentiometer.

**934: Analog retransmission of Process Variable or Set Variable:** (4 to 20 mA DC) For use as recorder, transmitter or computer A/D input. Linearized 4 to 20 mA DC signal follows the Process or Set variable. Scalable.

**936: Analog retransmission of Process Variable or Set Variable:** (0 to 10 VDC) Similar to option 934, but output signal is linearized 0 to 10 VDC.

**948: 4-Stage setpoint:** Four preset setpoints may be selected by external contacts. Each set point has its own set of PID values giving controller 4 distinct "recipes" for different process situations.

**992: RS-485 Computer communication link:** Allows remote computer to read and write all control parameters.

**993: RS-232 Computer communication link:** Allows remote computer to read and write all control parameters.

## Accessories

**AC744:** 1-10 A, 24 to 280 VAC SSR

**AC745:** 1-25 A, 24 to 280 VAC SSR

**AC746:** 1-50 A, 24 to 280 VAC SSR

**AC1009:** 1-20 A, 0 to 100 VDC SSR

**AC743:** SSR heat sink for high current or ambient temperature

**AC996 R/C Snubber:** Highly recommended to prolong relay contact life if using the mechanical relay or SSR output to drive a relay or solenoid. Also, for the CT16A AC SSR output, make sure that the coil HOLDING current is greater than 100 mA and voltage is minimum 48 VDC.

**AC1001:** Steel 1/16 to ¼ DIN adapter plate. 127×127 mm gray steel with 45×45 mm centered hole.

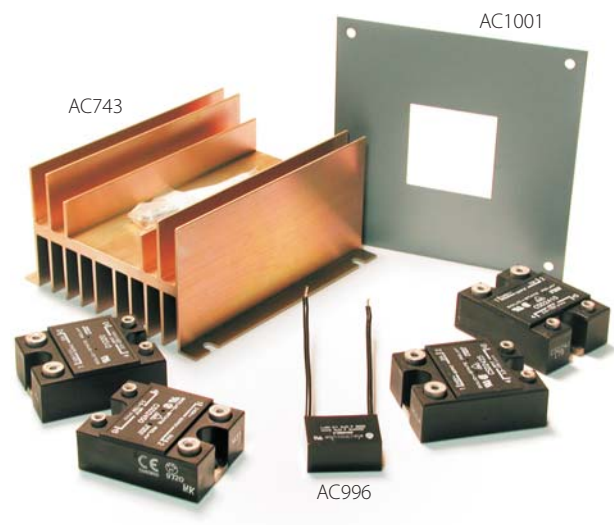

# Heater Accessories

## Thermostats

Thermostats provide basic heater control at little cost. You can also use them as thermal cutoffs in conjunction with other control systems. All thermostats come with a 1.5" (38.1 mm) long, silicone rubber coated sleeve for electrical insulation (case is electrically live), and mounting adhesive.

These thermostats are ordered separately. For information on ordering heaters with factory installed thermostats contact Access: Minco Sales and Support.

## Specifications

### Stock models:

TH100 creep action, 120 VAC maximum.  
TH200 snap action, 240 VAC maximum.

**Setpoint tolerance:** ±5°C (±9°F).

**Contact configuration:** Normally open (NO) above setpoint.

**Open/close differential:** 5 to 10°C, typical.

### Maximum current:

Model TH100: 6 amps at 120 VAC;  
8 amps at 12 VDC;  
4 amps at 24 VDC.  
Model TH200: 4 amps at 240 VAC.

**Life rating:** 100,000 cycles.

**Approvals:** UL, CSA.



## Specification options

|                               |   |
|-------------------------------|---|
| TH100                         | Model number: TH100 (creep action)  |
| T40                           | Setpoint options in °C (°F):<br>5 (41), 20 (68), 40 (104), 60 (140), 80 (176),<br>100 (212), 150 (302), 200 (392) |
| TH100T40 = Sample part number |   |

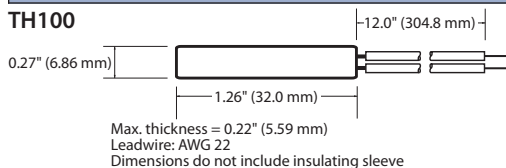

|                               |  |
|-------------------------------|--|
| TH200                         | Model number: TH100 (creep action)                                       |
| T80                           | Setpoint options in °C (°F):<br>60 (140), 80 (176), 100 (212), 150 (302) |
| TH200T80 = Sample part number |  |

## TH200

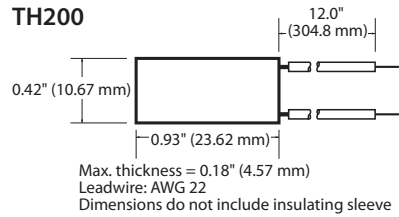

## Pre-cut insulators

Trimmed to the same size as heaters, these pads provide thermal insulation to minimize heat loss. You can also place them between clamping plates and heaters for uniform pressure. Optional pressure sensitive adhesive (PSA) backing permits easy installation. It will not bond permanently and may be removed later without damaging the heater.

| Material             | Thickness        | Temperature limit |        | R factor<br>Uncompressed |
|----------------------|------------------|-------------------|--------|--------------------------|
|                      |                  | with PSA          | no PSA |                          |
| Neoprene             | 0.125" (3.18 mm) | 107°C             | 107°C  | 23.1 °Cxm/W              |
| Silicone rubber foam | 0.125" (3.18 mm) | 204°C             | 204°C  | 9.2 °Cxm/W               |
| Mica                 | 0.010" (0.25 mm) | N/A               | 600°C  | 2.5 °Cxm/W               |
| Ceramic paper*       | 0.125" (3.18 mm) | N/A               | 600°C  | 11.5 °Cxm/W              |

\* Every mica heater comes with two sheets of ceramic paper free of charge. Order extra sheets here.

You can estimate heat loss with the following formula:

$$\text{Heat loss (W)} = \frac{A(T_f - T_a)}{1000 RL}$$

where:

- W = Watts of heat lost through insulation
- A = Heater area in square mm
- T<sub>f</sub> = Heat sink temperature in °C
- T<sub>a</sub> = Ambient temperature in °C
- R = R factor in °C × m/W
- L = Thickness of insulation in mm

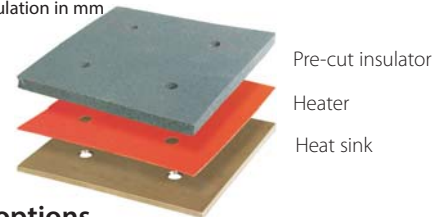

## Specification options

|                                |  |
|--------------------------------|--|
| IN                             | IN = Insulating pad  |
| 5334                           | Matching heater model number   |
| N1                             | Material:<br>N1 = Neoprene<br>R1 = Silicone rubber<br>M1 = Mica<br>C1 = Ceramic paper            |
| B                              | Pressure sensitive adhesive:<br>A = No PSA<br>B = With PSA backing<br>(N/A with ceramic or mica) |
| IN5334N1B = Sample part number |  |

Specifications subject to change

Sensors,  
Controllers &  
Accessories



# Frequently Asked Questions

## What is the correct voltage for this heater?

Standard heaters are specified by resistance, not voltage. This lets you operate them at different power levels. In selecting a heater model you should consider the size, resistance, operating temperature, total wattage and watt density (watts/in<sup>2</sup> or watts/cm<sup>2</sup>) for your application. The watt density rather than the total wattage determines the maximum applied voltage. Maximum watt density depends on the insulation type, mounting method and operating temperature. Graphs of these limits are included in each product section of this bulletin.

Minco standard and stock wire-wound silicone rubber heaters are listed with a recommended voltage based on typical ambient conditions and operation.

It is often possible to exceed the listed limits. Contact Minco for more information if your application requires more power than the standard limits allow.

## Can a Thermofoil™ heater be used suspended in air?

Because the mass of a Thermofoil heater is very small they are generally not suitable for heating in air. Thermofoil heaters operate best when mounted to an object that can be heated by conduction rather than convection or radiation.

## What are the dimensions of the lead attachment area for standard heaters?

The size of the non-heated lead attachment area varies based on the leadwire size, insulation material, lead exit location and heater dimensions. For a polyimide (e.g. Kapton™) insulated heater these range from 0.25 × 0.30" (6.35 × 7.62mm) to 0.5 × 0.8" (12.7 × 20.32 mm) for sizes AWG 30 to AWG 20. Describe your space limitations when specifying a custom design. Leads can be attached to a non-heated tab outside the body of the heater.

## What is the dielectric strength of each different insulation material?

Minco standard heaters with polyimide, silicone rubber or mica insulation are tested to verify 1000 VAC minimum dielectric breakdown voltage. We can provide custom models with thicker insulation to increase the dielectric rating, but this will reduce the maximum power and temperature ratings for the heater.

Another consideration is the amount of dielectric leakage current at operating voltage. Because an etched element covers 50% or more of the heater surface area, it can act as a capacitor when AC power is applied. The result is a leakage due to the capacitive effect. This is not a failure of the insulation but it may exceed the very low limits required for some medical and other applications. Minco can use special design techniques to minimize this leakage if your application requires meeting tight limits.

## What is the temperature coefficient of resistance (TCR) for Minco heater elements?

Standard etched element heaters (except resistance options listed under the "NiFe" and "Ni" columns) use very low TCR foil materials. These can be considered to have a flat resistance to temperature relation for most applications.

Etched element heaters under the "NiFe" and "Ni" columns use either nickel (0.00672 Ω/Ω/°C) or nickel-iron (0.00519 Ω/Ω/°C) foil. Thermal-Clear heaters use copper wire (0.00427 Ω/Ω/°C), nickel wire (0.00672 Ω/Ω/°C), or nickel-iron wire (0.00519 Ω/Ω/°C). These higher TCR models are not self-limiting but can be used with Minco's Heaterstat controller where the heater element performs the sensor function.

## Can I immerse these heaters in water or other liquids?

Generally the answer is no. The materials used in Polyimide insulated Thermofoil heaters are waterproof, but edges are not sufficiently sealed for immersion. Custom designs (including all PTFE heaters) can include increased border areas and sealed leadwire connections that make these heaters immersible in water. Silicone rubber insulated heaters require RTV cement or similar materials along all exposed edges and leadwire attachment areas for immersion in water.

If your application requires contact with other liquids contact Access: Minco Sales and Support with details and we can help design a solution.

## Can I trim a Thermofoil heater to the size and shape I need after I've received it?

No- Thermofoil heaters cannot be cut or trimmed. The element conductor covers the entire area to maximize the heat spreading effect of the etched-foil design. Cutting into this would create an electrically open circuit and expose the electrically live element.

## When would I specify aluminum foil backing for a heater?

Foil helps to spread heat between heater strands, improves adhesion of PSA, and makes polyimide less springy for better conformance to curves. It increases the temperature and watt density ratings of polyimide heaters with PSA. For silicone rubber heaters, foil with acrylic PSA is less expensive than #12 PSA applied directly to the rubber.

# Glossary

**Anti-reset windup:** Turns off integral action outside the proportional band to prevent false accumulation of error during warmup.

**AP (All-Polyimide):** Flexible heaters with adhesiveless substrate and covers. High temperature capabilities to 260°C.

**AWG (American Wire Gauge):** An indicator of wire diameter. The larger the number, the smaller the diameter.

**Conduction:** The transfer of thermal energy between adjacent bodies (usually solids) or parts of the same body.

**Convection:** The transfer of thermal energy in fluids and gases by mixing warmer areas with cooler ones. Convection currents can form, due to differences in density. Generally, warmer fluids (or gases) are less dense and tend to rise.

**Creep action:** A switching method, often used in thermostats, in which a temperature-sensitive bi-metallic element causes slow make and break of electrical connections. In contrast to snap action, this method results in tighter temperature control, but greater electrical noise and usually shorter life.

**Cycle time:** The duration of an on/off cycle with time proportioning. With cycle time of 10 seconds, for example, 80% power would give 8 seconds on, 2 seconds off. General rule: Shorter times give better control and less oscillation, but require solid state relay.

**Deadband:** The temperature difference between full “on” (when temperature is falling), and full “off” (when temperature is rising), for an on/off controller. The deadband is intentionally designed to reduce oscillation.

**Derivative:** Adjustment to output based on the process’s rate of change, usually to allow faster recovery from upsets. Also expressed as “rate.” General rule: Increase derivative time if system frequently overshoots; decrease if system acts sluggish.

**Dielectric strength:** The maximum voltage (typically AC) that an insulation material can withstand before material break down occurs.

**Droop:** An error inherent in simple proportional control where the temperature reaches equilibrium at a point other than setpoint, but still within the proportional band.

**Etched-foil:** A method of producing pre-determined electrical paths, by chemically removing (etching) the areas which will not carry electric current. This process can be used to manufacture heaters, flex-circuits, and temperature sensors.

**FEA (Finite Element Analysis):** A numerical method used to predict the behavior of a heater/heat sink design. It is typically employed only if actual modeling is not practical.

**FEP (Fluorinated Ethylene Propylene):** A thermoplastic adhesive in the PTFE family of polymers.

**Flex circuit:** A printed circuit made with flexible materials for compact electrical interconnects.

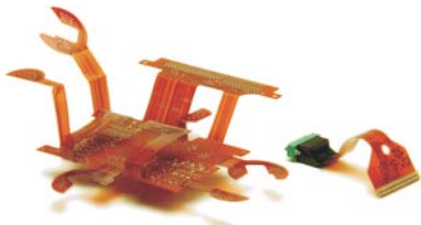

**Fuzzy logic:** A control scheme that operates in addition to PID and gives the controller more “common sense” for dealing with unpredictable systems. Not required for most heating situations.

**Heat sink:** The body to which a heater is affixed.

**Heat transfer:** The transfer of thermal energy between bodies of different temperature.

**Heaterstat™:** A Minco temperature controller that uses the heating element as a temperature feedback sensor.

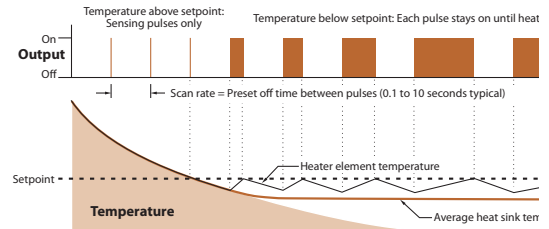

**Hysteresis:** The temperature difference between full “on” (when temperature is falling), and full “off” (when temperature is rising), for an on/off controller.

**Insulation resistance:** The actual resistance of an electrically insulating material. Measuring devices typically use high DC voltage to perform the measurement.

**Integral:** A controller feature that continuously compensates for droop by integrating errors over time and adjusting the proportional band up and down. Also expressed as “reset” (integral time = 1/reset rate). General rule: Short integral times give faster correction, but too short causes oscillation.

**ISO 9001:** A quality management system that is accepted worldwide.

**Laminate:** To bond materials using heat and pressure.

**Mica:** A fairly brittle phyllosilicate mineral used to insulate heaters. It is used primarily for its high temperature and high watt density capabilities.

**NASA (National Aeronautics and Space Administration):** The U.S. agency for space exploration.

**Ohm’s law:**  $E = I \cdot R$ . See page 6.

**On/off:** A simple control scheme where output is on below the setpoint, off above, as with a thermostat.

**Outgassing:** The expulsion of gases, especially in a vacuum or high temperature environment.

**PID (Proportional, Integral, Derivative):** A control algorithm incorporating proportional, integral, and derivative action.

**Polyester:** A synthetic polymer used to electrically insulate heaters, flex-circuits, and Thermal-Ribbons™. It is an economic alternative to polyimide, when high temperature and chemical resistance are not critical.

**Polyimide (Kapton™):** A flexible, amber-colored, translucent film to electrically insulate heaters, flex circuits, and Thermal-Ribbons™. It is widely used for its temperature range and resistance to chemicals. DuPont’s tradename for Polyimide is Kapton™.

**Profile:** A method of providing uniform temperature, by varying watt density in a single heater to accommodate non-uniform heat loss from the heat sink.

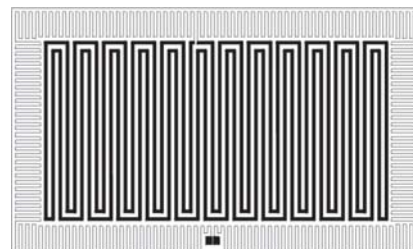



# Glossary

**Proportional band:** A region around the setpoint where the output is proportional to the process's distance from that setpoint. For example, 100% heater power during warmup is proportioned to 75%, then 50%, then 25% as temperature nears setpoint. General rule: Set just wide enough to prevent temperature from wandering outside band during normal operation.

**Proportional control:** A control method where the controller output is proportional to the temperature difference from set point.

**PSA (Pressure-Sensitive Adhesive):** An adhesive that does not require heat or extreme pressure to apply. Simply peel off the release liner, and firmly press into place.

**PTFE (polytetrafluoroethylene):** A flexible electrically insulating material known for its "non-stick" characteristic. It is often used for its excellent chemical resistance. DuPont's tradename for PTFE is Teflon™.

**Radiation:** The transfer of thermal energy through space (especially a vacuum) by electromagnetic waves.

**Resistance density:** Resistance per unit area. Usually listed as a maximum, it is dependent upon construction materials such as foil, adhesive, and insulation.

**Resistance tolerance:** The range of actual resistance from nominal (or target resistance), at a reference temperature (usually 0°C). Generally, wire elements have a tighter resistance tolerance than etched foil elements.

**RS-485:** A communication standard for interfacing computers to process instruments. Allows multiple instruments on a single twisted-pair cable. Convertible to RS-232 with proper adapter.

**RTD (Resistance Temperature Detector):** A sensor whose resistance changes with temperature. The most accurate of commonly used thermometer types.

**Self-Tune:** The ability of the CT15 or CT16A to set its own PID parameters to best match the process. Can be set either to learn once or to continuously observe and adjust.

**SensorCalc:** A Minco web-based program that provides resistance versus temperature data for a variety of sensors and heaters.

**Shrink band:** Pre-stretched strips, that shrink when heat is applied, for mounting heaters or temperature sensors to cylinders.



**Silicone rubber:** A flexible, synthetic elastomer used to electrically insulate heaters and Thermal-Ribbons™.

**SMT (Surface Mount Technology):** A printed circuit wiring method that uses solder pads on the surface of the circuit to mount components, thereby eliminating through-holes.

**Snap action:** A switching method, often used in thermostats, in which a temperature-sensitive bi-metallic element causes fast make and break of electrical connections. In contrast to creep action, this method results in less electrical noise, but requires a significant differential between temperatures that open and close the connection, resulting in looser control.

**Specific heat:** The amount of heat per unit mass required to raise the temperature of a material 1°C.

**SSR (Solid State Relay):** A type of relay with no moving contacts to wear out, offering life many times that of mechanical relays. Best for time proportioning.

**Standard heaters:** Predesigned heaters that are made-to-order. Typical lead time on Minco standard heaters is 3 weeks ARO.

**Stretch tape:** An elastic, silicone rubber tape for mounting heaters or temperature sensors to cylinders.

**TCR (Temperature Coefficient of Resistance):** The average resistance change per unit resistance between 0°C and 100°C. Sometimes it is simplified to the ratio of resistance at 100°C to the resistance at 0°C.

**Thermal Calc:** A Minco web-based program to assist in calculating heater wattage requirements from known parameters.

**Thermal-Clear™:** A heater made with transparent insulation and a fine wire element. Thermal-Clear heaters transmit over 80% of visible light.

**Thermal conductivity:** A measure of how fast heat travels through a material. Often referred to as the "k" value.

**Thermal-Ribbon™:** Minco's family of flexible temperature sensors, featuring a wide variety of resistance, TCR, and temperature ranges. Thermal-Ribbons can be integrated into a heater, or custom designed to virtually any shape.



**Thermistor:** A temperature sensor made from semiconductive material. Thermistors are highly sensitive (resistance changes dramatically with temperature), but non-linear and typically not very accurate.

**Thermocouple:** A temperature sensor made by joining two dissimilar metals at discrete points called junctions. Thermocouples produce a small voltage when there is a difference in temperature between junctions.

**Thermofoil™:** An innovative heating technology from Minco, which utilizes an etched-foil process to create a flat, flexible heater for optimum heat transfer. Heaters can be designed in virtually any shape, and Minco can integrate temperature sensors, flex circuits, and control electronics.

**Thermostat:** A temperature-sensitive switch used as an economical on/off controller, or for overtemperature protection. See "snap action" and "creep action."

**Thin-film:** An electrical component made by depositing a thin layer of metal on a substrate (usually ceramic). Thin film techniques can be used to make heaters or temperature sensors.

**Time proportioning:** Scaling of output by varying the ratio of on-time to off-time; i.e. 80% power = 80% full on, 20% off.

**TÜV:** A testing and certification organization, through which Minco has ISO 9001 accreditation, and other approvals.

**UL (Underwriters Laboratories):** An independent product safety testing and certification organization, recognized mostly in the United States and Canada..

**ULA:** A thermosetting, acrylic adhesive that is UL recognized.

**Vulcanize:** A process, using heat and pressure, used to bond uncured rubber to rubber, metal, ceramic, glass, etc.

**WA:** A thermosetting acrylic adhesive.

**Watt:** The heat produced by one ampere of current through a resistive load of one ohm.

**Watt density:** The amount of power per unit area, often expressed as watts per square inch or watts per square centimeter.

# Industry Specifications for Heaters

## ISO 9001: 2000 / AS/EN/SJAC9100 (Registrar: TÜV)

Minco's Quality Assurance system has been audited and certified compliant with these internationally recognized standards.

## UL: Underwriters Laboratories

United States:

UL 499; Standard for Safety for Electric Heating Appliances

UL file number: E89693



Custom designed or standard model heaters with polyimide, all-polyimide, mica, or silicone rubber insulation may be marked as recognized components.

Canada:

Specification C22.2, 72-M1984

UL file number: E89693



Custom designed or specially modified standard model heaters with polyimide, mica, all-polyimide or silicone rubber insulation may be marked as recognized components.

United States and Canada:

Specification C22.2, 72-M1984

UL file number: E89693



Custom designed or specially modified standard model heaters with polyimide, mica, all-polyimide or silicone rubber insulation may be marked as recognized components.

## TÜV

Specification EN60335-1: Standards for Safety of Household and Similar Electrical Appliances, Part 1: General Requirements

Custom designed or standard model heaters with polyimide or silicone rubber

insulation may be marked as recognized components.



## NASA: National Aeronautics and Space Administration of the United States

Specification S-311-P-079: Procurement Specification for Thermofoil™ Heaters

Minco has worked closely with NASA developing precise, reliable thermal components since the Mercury program in the 1960's. Hundreds of custom designed Thermofoil™ heaters have been built, tested and supplied for NASA projects. Minco is the only supplier of heating elements included in the NASA's

QPL (Qualified Producer List).

## Astrium (consortium of British, French, German and Spanish manufacturers of aerospace and satellite equipment)

Specification MA1144 (France) of the Space Components Procurement Agency and Specification SHT01-001 (UK)

Minco has qualified and supplied hundreds of custom models of Thermofoil™ heaters for satellite applications with these partners for over 20 years.

## CENELEC: European Committee for Electrotechnical Standardization

Specification EN50014: Electrical Apparatus for Potentially Explosive Atmospheres: General Requirements and Specification EN50019: Electrical Apparatus for Potentially Explosive Atmospheres: Increased Safety Apparatus

Minco has qualified specific models of Thermofoil™ heater assemblies used in potentially hazardous areas to these international requirements.

## Telcordia Technologies (Bellcore)

Specification GR-1221-CORE: General Reliability Assurance Requirements for Passive Optical Components

Polyimide and rubber insulated Thermofoil™ heaters have been tested to these requirements of the telecommunications industry. Standard and custom designs, heater/sensors, and heater assemblies meet the requirements of this specification.

## White Papers

Get these white papers at Minco at <http://www.minco.com>

- Estimating Power Requirements for Etched-Foil Heaters
- Prototyping Techniques for Etched-Foil Heaters
- Comparison of Thin-Film and Wire-Wound Heaters for Transparent Applications
- Designing Heated Chucks for Semiconductor Processing Equipment
- And more...

# Next Steps

---

Minco welcomes the opportunity to help you design and manufacture a heating solution that meets and exceeds your expectations. That is why we have established a variety of communication channels so that we may encourage meaningful exchange and dialog.

Call **Access: Minco** Sales and Support – Americas - 763.571.3121  
Europe - (33) 5 61 03 24 01  
Asia Pacific - (65) 6511 3388

The Access: Minco Sales and Support team is trained and equipped to promptly handle complex questions regarding product orders, quote requests, engineering questions, and other issues that require comprehensive customer support.

Submit a request for quote – [www.minco.com/rfq/](http://www.minco.com/rfq/)

Send us your application specifications and component needs, and a Minco representative will contact you by phone or email to confirm your request and send you a reliable quotation.

Access technical information and application ideas - [www.minco.com](http://www.minco.com)



**Worldwide Headquarters**

7300 Commerce Lane  
Minneapolis, MN 55432 USA  
Tel: 1.763.571.3121  
Fax: 1.763.571.0927  
sales@minco.com  
www.minco.com

**European Headquarters**

Usine et Service  
Commercial, Z.I.  
09310 Aston, France  
Tel: (33) 5 61 03 24 01  
Fax: (33) 5 61 03 24 09

**Asia Pacific Headquarters**

20 Science Park Road  
#02-31 Teletech Park  
Singapore Science Park II  
Singapore 117674  
Tel: (65) 6511 3388  
Fax: (65) 6511 3399

ISO 9001:2000  
HDG01121806R0  
© Minco 2016



Flex Circuits  
Thermofoil™ Heaters  
Sensors  
Instruments