

## Exchangeable Thermocouple Probes

For each application, ebro provides the right thermometer and also offers a wide selection of precise and robust probes for the following thermometers:

- TTX 120 (see page 90)
- TFN 520 series (starting on page 90)
- TFN 530 series (starting on page 90)
- TFI 550 (see page 103)
- TFI 650 (see page 103)



To solve each of your measurement tasks perfectly, you can choose between various probe types:

- Low-cost probes
- Rod probes
- Surface probes
- High temperature probes
- Other probes

The probes are available with Lemo and/or SMP connection.

Find your perfect probe on the next pages.

## Extension cables for probes

*Please find more information on page 92.*



**AN 140** Extension cable, 1 m silicone with Lemo connection



**AN 142** Extension cable, 1 m silicone, SMP



**AN 141** Adapter cable, 1 m silicone (Lemo/SMP)

**AN 144** Extension cable, 2.5 m silicone, SMP



**AN 143** Extension cable, 2.5 m silicone, Lemo

Type	Description	Part No.
AN 140	Extension cable, 1m silicone, Lemo	1341-2626
AN 141	Adapter cable, 1m silicone (Lemo/SMP)	1341-2629
AN 142	Extension cable, 1m silicone, SMP	1343-2626
AN 143	Extension cable, 2.5m silicone, Lemo	1341-2627
AN 144	Extension cable, 2.5m silicone, SMP	1343-2627

## Low-cost probes

*Temperature measurement of plastic masses, fluids, air and surfaces.*

## Penetration probes

### TPN 200

- Probe (L = 185, Ø 3 mm, pointed, inconel needle with tip, without cable, with Lemo connection)
- Range: -40 °C ... +1100 °C
- Accuracy: exceeds DIN IEC 584, class 2
- Response time ( $t_{99}$ ): 3 sec

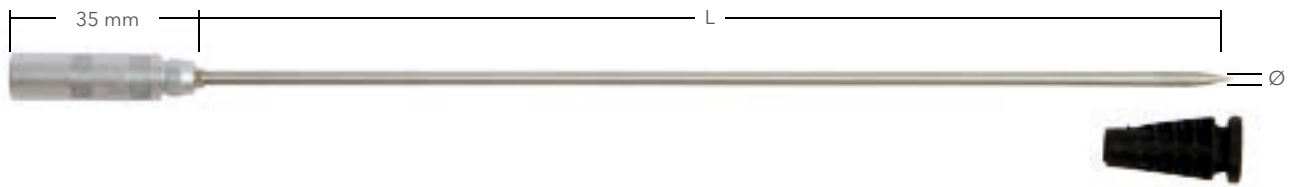

### TPN 210

- Probe (L = 130 mm, Ø 3 mm, pointed, stainless steel, up to +400 °C, with 1 m silicone cable, with Lemo connection)
- Range: -40 °C ... +400 °C
- Accuracy: exceeds DIN IEC 584, class 1

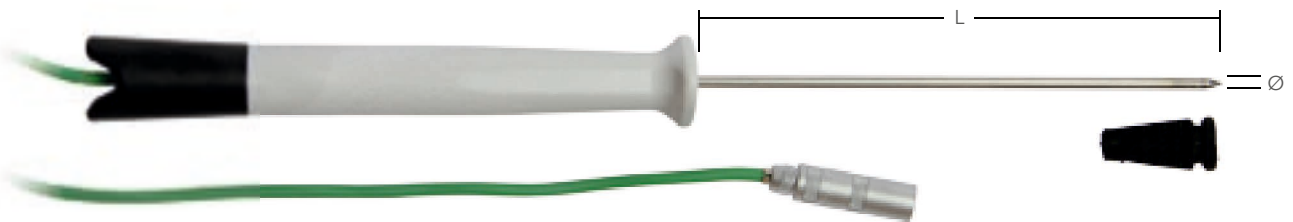

### TPN 211

- same as TPN 210 but with SMP connection



Type	Description	Part No.
TPN 200	Penetration probe, L = 185 mm, Ø 4 mm, pointed, Lemo	1341-0608
TPN 210	Penetration probe with 1m silicone cable, L = 130 mm, Ø 3 mm, pointed, Lemo	1341-1005
TPN 211	Penetration probe with 1m silicone cable, L = 130 mm, Ø 3 mm, pointed, SMP	1343-1005

## Surface paddle probes

### TPN 340

- Probe (Paddle: 40 x 7 x 0.35 mm, stainless steel sheet, for surfaces up to +400 °C, with 1m silicone cable, with Lemo connection)
- Range: -50 °C ... +400 °C
- Accuracy: exceeds DIN IEC 584, class 1



### TPN 341

- same as TPN 340 but with SMP connection

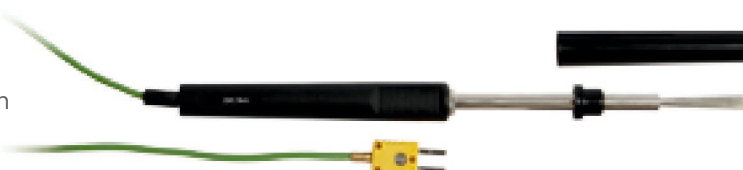

Type	Description	Part No.
TPN 340	Surface / Paddle probe with 1 m silicone cable, 40 x 7 x 0.35 mm paddle, Lemo	1341-1015
TPN 341	Surface / Paddle probe with 1 m silicone cable, 40 x 7 x 0.35 mm paddle, SMP	1343-1015

## Immersion probes

### TPN 400

- Probe (L = 130 mm, Ø 3 mm, blunt, stainless steel, up to +1000 °C, with 1 m silicone cable, with Lemo connection)
- Range: -40 °C ... +400 °C
- Accuracy: exceeds DIN IEC 584, class 1

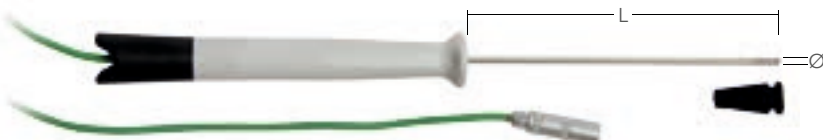

### TPN 401

- same as TPN 400 but with SMP connection



Type	Description	Part No.
TPN 400	Immersion probe with 1 m silicone cable, L = 130 mm, Ø 3 mm, blunt, Lemo	1341-1000
TPN 401	Immersion probe with 1 m silicone cable, L = 130 mm, Ø 3 mm, blunt, SMP	1343-1000

## Rod probes

### Basic rod probes

*Temperature measurement of air, ovens, fluids and gases.*

#### TPN 100

- Probe (L = 185 or 300 mm, Ø 0.5 mm, pointed, inonel needle, with Lemo connection)
- Range: -40 °C ... +1100 °C
- Accuracy: exceeds DIN IEC 584, class 2
- Response time ( $t_{99}$  water 0.2m/s): 0.4 sec



#### TPN 110

- Probe (L = 185, 300 or 500 mm, Ø 1 mm, pointed, inonel needle, with Lemo connection)
- Range: -40 °C ... +1100 °C
- Accuracy: exceeds DIN IEC 584, class 2
- Response time ( $t_{99}$  water 0.2m/s): 1sec
- Approved according to guideline 94/9 ATEX



#### TPN 111 same as TPN 110 but

- Probe (L = 185 or 500 mm)
- with SMP connection



#### TPN 120

- Probe (L = 185, 300, 500, 600, 700 or 1000 mm, Ø 1.5 mm, pointed, inonel needle, with Lemo connection)
- Range: -40 °C ... +1100 °C
- Accuracy: exceeds DIN IEC 584, class 2
- Response time ( $t_{99}$  water 0.2 m/s): 2sec
- Approved according to guideline 94/9 ATEX



#### TPN 121 same as TPN 120 but

- Probe (L = 185, 300 or 400 mm)
- with SMP connection



**TPN 140**

- Probe (L = 185 or 300 mm, Ø 3 mm, pointed, inconel needle, with Lemo connection)
- Range: -40 °C ... +1100 °C
- Accuracy: exceeds DIN IEC 584, class 2
- Response time (t<sub>99</sub> water 0.2 m/s): 4 sec
- Approved according to guideline 94/9 ATEX



**TPN 141**

- same as TPN 140 but with SMP connection



Type	Description	Part No.
TPN 100	Rod probe without cable, L = 185 mm, Ø 0.5 mm, pointed, Lemo	1341-0611
TPN 100-30	Rod probe without cable, L = 300 mm, Ø 0.5 mm, pointed, Lemo	1341-0805
TPN 110	Rod probe without cable, L = 185 mm, Ø 1 mm, pointed, Lemo	1341-0810
TPN 110-30	Rod probe without cable, L = 300 mm, Ø 1 mm, pointed, Lemo	1341-0812
TPN 110-50	Rod probe without cable, L = 500 mm, Ø 1 mm, pointed, Lemo	1341-0814
TPN 111	Rod probe without cable, L = 185 mm, Ø 1 mm, pointed, SMP	1343-0810
TPN 111-50	Rod probe without cable, L = 500 mm, Ø 1 mm, pointed, SMP	1343-0814
TPN 120	Rod probe without cable, L = 185 mm, Ø 1.5 mm, pointed, Lemo	1341-0609
TPN 120-30	Rod probe without cable, L = 300 mm, Ø 1.5 mm, pointed, Lemo	1341-0400
TPN 120-50	Rod probe without cable, L = 500 mm, Ø 1.5 mm, pointed, Lemo	1341-0406
TPN 120-60	Rod probe without cable, L = 600 mm, Ø 1.5 mm, pointed, Lemo	1341-0409
TPN 120-70	Rod probe without cable, L = 700 mm, Ø 1.5 mm, pointed, Lemo	1341-0412
TPN 120-100	Rod probe without cable, L = 1000 mm, Ø 1.5 mm, pointed, Lemo	1341-0414
TPN 121	Rod probe without cable, L = 185 mm, Ø 1.5 mm, pointed, SMP	1343-0609
TPN 121-30	Rod probe without cable, L = 300 mm, Ø 1.5 mm, pointed, SMP	1343-0400
TPN 121-40	Rod probe without cable, L = 400 mm, Ø 1.5 mm, pointed, SMP	1343-0403
TPN 140	Rod probe without cable, L = 185 mm, Ø 3 mm, pointed, Lemo	1341-0607
TPN 140-30	Rod probe without cable, L = 300 mm, Ø 3 mm, pointed, Lemo	1341-0415
TPN 141	Rod probe without cable, L = 185 mm, Ø 3 mm, pointed, SMP	1343-0607
TPN 141-30	Rod probe without cable, L = 300 mm, Ø 3 mm, pointed, SMP	1343-0415

**Glass coated rod probes**

*Temperature measurement in chemically aggressive stages and fluids (materials reacting with stainless steel).*

**TPN 132-20**

- Probe (L = 200, 300 or 400 mm, Ø 8 mm, coated with Duran glass, with Lemo connection)
- Range: -40 °C ... +1100 °C
- Accuracy: exceeds DIN IEC 584, class 2
- Response time (t<sub>99</sub> water): 40 sec

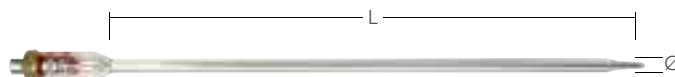

Type	Description	Part No.
TPN 132-20	Rod probe without cable, L = 200 mm, Ø 8 mm, glass-coated, Lemo	1342-0200
TPN 132-30	Rod probe without cable, L = 300 mm, Ø 8 mm, glass-coated, Lemo	1342-0300
TPN 132-40	Rod probe without cable, L = 400 mm, Ø 8 mm, glass-coated, Lemo	1342-0400

## Surface probes

### General purpose surface probes

*Surface temperature measurement of motors, turbines, pumps, casting molds, heating tubes, heating plates, injection molding, heating boilers, incinerators etc.*

#### TPN 360

- Probe (L = 30mm, with 1m silicone cable, with Lemo connection)
- Range: -50 °C ... +500 °C
- Accuracy: exceeds DIN IEC 584, class 1
- Response time ( $t_{99}$ ): 1.5 sec
- Approved to guideline 94/9 ATEX



#### TPN 361

- same as TPN 360 but with SMP connection



#### TPN 380

- Probe (L = 300mm, with 1m silicone cable, with Lemo connection)
- Range: -50 °C ... +800 °C
- Accuracy: exceeds DIN IEC 584, class 1
- Response time ( $t_{99}$ ): 1.5 sec
- Particular suitable for hot surfaces

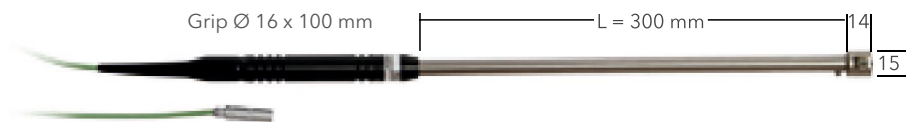

#### TPN 381

- same as TPN 380 but with SMP connection



Type	Description	Part No.
TPN 360	Surface probe with 1m silicone cable, L = 30 mm, up to +500 °C, Lemo	1341-0710
TPN 361	Surface probe with 1m silicone cable, L = 30 mm, up to +500 °C, SMP	1343-0710
TPN 380	Surface probe with 1m silicone cable, L = 300 mm, up to +800 °C, Lemo	1341-0720
TPN 381	Surface probe with 1m silicone cable, L = 300 mm, up to +800 °C, SMP	1343-0720

## Surface probes for sensitive surfaces

Surface temperature measurement of plastic, glass, gum, paper, metal, injection molding, tubes etc. To protect sensitive surfaces, the probe heads consist of PTFE.

### TPN 310

- Probe (Measuring tape: N-version, with 1m silicone cable, with Lemo connection)
- Range: -50 °C ... +300 °C
- Accuracy: exceeds DIN IEC 584, class 1
- Response time ( $t_{99}$ ): 1.5 sec
- For highly sensitive surfaces



### TPN 311

- same as TPN 310 but with SMP connection



### TPN 320

- Probe (Measuring tape: N-version, with 1m silicone cable, with Lemo connection)
- Range: -50 °C ... +300 °C
- Accuracy: exceeds DIN IEC 584, class 1
- Response time ( $t_{99}$ ): 1.5 sec
- For highly sensitive surfaces



### TPN 321

- same as TPN 320 but with SMP connection



Type	Description	Part No.
TPN 310	Surface probe with 1m silicone cable, -50 °C ... +300 °C, Lemo	1341-0702
TPN 311	Surface probe with 1m silicone cable, -50 °C ... +300 °C, SMP	1343-0702
TPN 320	Surface probe with 1m silicone cable, -50 °C ... +300 °C, Lemo	1341-0717
TPN 321	Surface probe with 1m silicone cable, -50 °C ... +300 °C, SMP	1343-0717



## Surface probes for hard to reach surfaces

### Surface temperature measurement of machine parts.

#### TPN 350

- Probe (L = 100mm, with 1m silicone cable, with Lemo connection)
- Range: -50 °C ... +500 °C
- Accuracy: exceeds DIN IEC 584, class 1
- Response time ( $t_{99}$ ): 1.5 sec

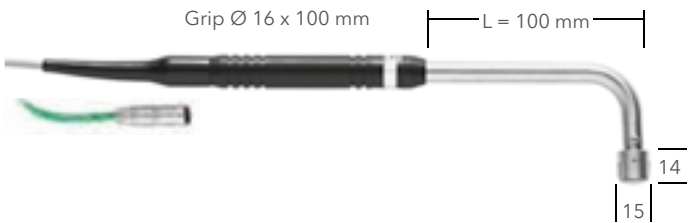

#### TPN 351

- same as TPN 350 but with SMP connection

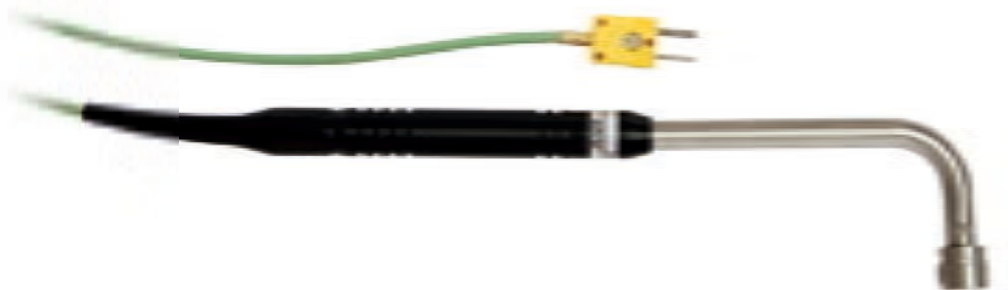

#### TPN 390

- Probe (L = 300mm, with 1m silicone cable, with Lemo connection)
- Range: -50 °C ... +800 °C
- Accuracy: exceeds DIN IEC 584, class 1
- Response time ( $t_{99}$ ): 1.5 sec
- Particular suitable for hot surfaces

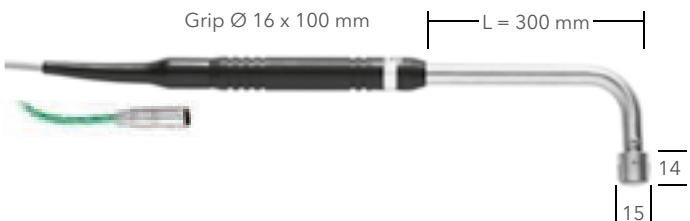

#### TPN 391

- same as TPN 390 but with SMP connection



Type	Description	Part No.
TPN 350	Surface probe with 1m silicone cable, L = 100 mm, up to +500 °C, Lemo	1341-0712
TPN 351	Surface probe with 1m silicone cable, L = 100 mm, up to +500 °C, SMP	1343-0712
TPN 390	Surface probe with 1m silicone cable, L = 300 mm, up to +800 °C, Lemo	1341-0721
TPN 391	Surface probe with 1m silicone cable, L = 300 mm, up to +800 °C, SMP	1343-0721

## Surface probes with mini sensor

Temperature measurement on very small surfaces like boards, small transformers, small heating blocks, thin tubes, rotors as well as materials such as plastic, glass, gum and metal.

### TPN 330

- Probe (Probe head: Econol, slightly angled, with 1m silicone cable, with Lemo connection)
- Range: -50 °C ... +250 °C
- Accuracy: exceeds DIN IEC 584, class 1
- Response time ( $t_{99}$ ): 0.5 sec



### TPN 331

- same as TPN 330 but with SMP connection



### TPN 1100

- Probe (Measuring head: Ø 3.8 mm, Measuring tape: coated with polyimid film, with 1m silicone cable, with Lemo connection)
- Range: -50 °C ... +400 °C
- Accuracy: exceeds DIN IEC 584, class 2
- Response time ( $t_{99}$ ): 2.0 sec



### TPN 1101

- same as TPN 1100 but with SMP connection



### TPN 1110

- Probe (Measuring head: Ø 3.8 mm, Measuring tape: coated with polyimid film, with 1m silicone cable, with Lemo connection)
- Range: -50 °C ... +400 °C
- Accuracy: exceeds DIN IEC 584, class 2
- Response time ( $t_{99}$ ): 2.0 sec



### TPN 1111

- same as TPN 1110 but with SMP connection



Type	Description	Part No.
TPN 330	Surface probe with 1m silicone cable, 6 x 6 x 20 mm, Lemo	1341-0635
TPN 331	Surface probe with 1m silicone cable, 6 x 6 x 20 mm, SMP	1343-0635
TPN 1100	Mini surface probe with 1m silicone cable, Ø 3,8 mm, up to +400 °C, Lemo	1341-0653
TPN 1101	Mini surface probe with 1m silicone cable, Ø 3,8 mm, up to +400 °C, SMP	1343-0653
TPN 1110	Mini surface probe with 1m silicone cable, Ø 3,8 mm, up to +400 °C, Lemo	1341-0654
TPN 1111	Mini surface probe with 1m silicone cable, Ø 3,8 mm, up to +400 °C, SMP	1343-0654

## Magnetic surface probes

Surface temperature measurement on an extended period of ferrous containing compounds, e.g. heating plates, heating tubes, pumps, flushing tools, motors, turbines etc.

### TPN 900

- Probe (Contact area: 27 x 30 mm, with 1m silicone cable, with Lemo connection)
- Range: -50 °C ... +250 °C
- Accuracy: exceeds DIN IEC 584, class 1
- Response time ( $t_{99}$ ): 2.0 sec
- Contact pressure: by magnetic force

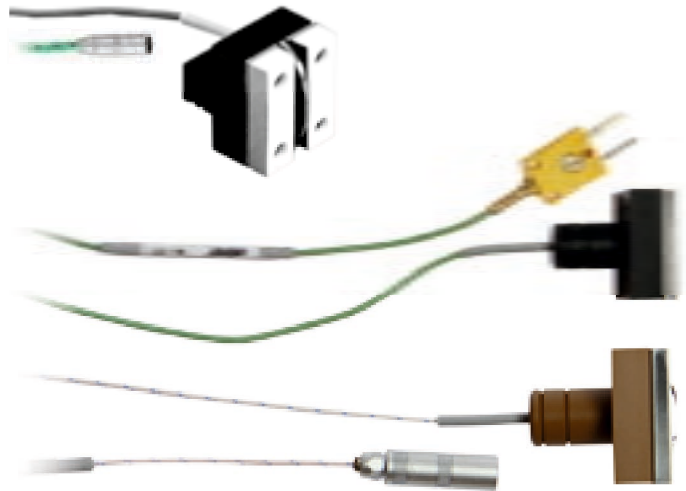

### TPN 901

- same as TPN 900 but with SMP connection

### TPN 920 same as TPN 900 but

- with 1m glasscoated cable
- Range: -50 °C ... +400 °C

### TPN 910

- Probe (Contact area: 11 x 15 mm, Thermocouple coated with polyamid film, with 1m glasscoated cable, with Lemo connection)
- Range: -50 °C ... +400 °C
- Accuracy: exceeds DIN IEC 584, class 1
- Response time ( $t_{99}$ ): 2.0 sec
- Contact pressure: by magnetic force



### TPN 911

- same as TPN 910 but with SMP connection

### TPN 912 same as TPN 910 but

- with 1m silicone cable
- Range: -50 °C ... +250 °C

### TPN 913

- same as TPN 912 but with SMP connection



Type	Description	Part No.
TPN 900	Magnetic surface probe with 1 m silicone cable, 25 x 30 mm, up to +250 °C, Lemo	1341-0640
TPN 901	Magnetic surface probe with 1 m silicone cable, 25 x 30 mm, up to +250 °C, SMP	1343-0640
TPN 910	Magnetic surface probe, with 1 m glasscoated cable, 11 x 15 mm, up to +400 °C, Lemo	1341-0641
TPN 911	Magnetic surface probe, with 1 m glasscoated cable, 11 x 15 mm, up to +400 °C, SMP	1343-0641
TPN 912	Magnetic surface probe, with 1 m silicone cable, 11 x 15 mm, up to +250 °C, Lemo	1341-0644
TPN 913	Magnetic surface probe, with 1 m silicone cable, 11 x 15 mm, up to +250 °C, SMP	1343-0644
TPN 920	Magnetic surface probe with 1 m glasscoated cable, 25 x 30 mm, up to +400 °C, Lemo	1341-0642

### Roller surface probes

*Temperature measurement of solid, moving and rotating surfaces, such as turned parts, rollers, metal and paper blanks as well as at mold design and construction.*

#### TPN 700

- Probe (Measuring head with PTFE runners (35 x 60 mm) (5 different types for rollers Ø 85–600 mm), with 1 m silicone cable, with Lemo connection)
- Range: -50 °C ... +250 °C
- Accuracy: exceeds DIN IEC 584, class 1
- Response time ( $t_{99}$ ): 3.0 sec
- Max. speed: 800m/min

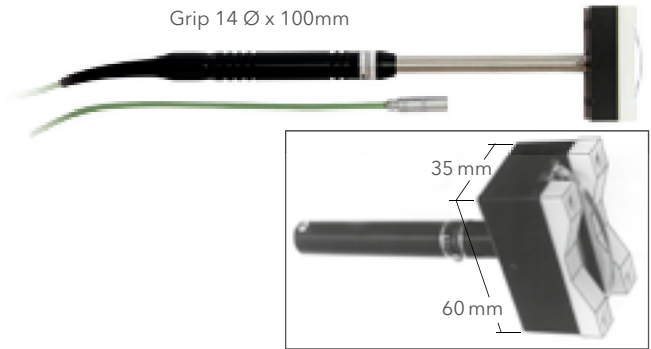

#### TPN 701

- same as TPN 700 but with SMP connection



Type	Description	Part No.
TPN 700	Roller probe with 1 m silicone cable, 35 x 60 mm PTFE runners, Ø 85-600 mm up to flat, Lemo	1341-0845
TPN 701	Roller probe with 1 m silicone cable, 35 x 60 mm PTFE runners, Ø 85-600 mm up to flat, SMP	1343-0845

### Sheet surface probes

*Temperature measurement in stacked goods, such as wood, paper, ironing presses etc.*

#### TPN 1010

- Probe (Sheet length: 75 mm, Sheet thickness: 0.05mm at the measuring surface, with 1 m silicone cable, with Lemo connection)
- Range: -50 °C ... +210 °C
- Accuracy: exceeds DIN IEC 584, class 1
- Response time ( $t_{99}$ ): 2.0 sec



#### TPN 1011

- same as TPN 1010 but with SMP connection



Type	Description	Part No.
TPN 1010	Sheet probe with 1 m silicone cable, up to +210 °C, Lemo	1341-0652
TPN 1011	Sheet probe with 1 m silicone cable, up to +210 °C, SMP	1343-0652

**Rail surface probes**  
*Temperature measurement of moving surfaces.*

**TPN 800**

- Probe (Measuring head: (33 x 50 mm) with rollers, with 1m silicone cable, with Lemo connection)
- Range: -50 °C ... +250 °C
- Accuracy: exceeds DIN IEC 584, class 1
- Response time ( $t_{99}$ ): 3 sec
- Max. speed: 500 m/min

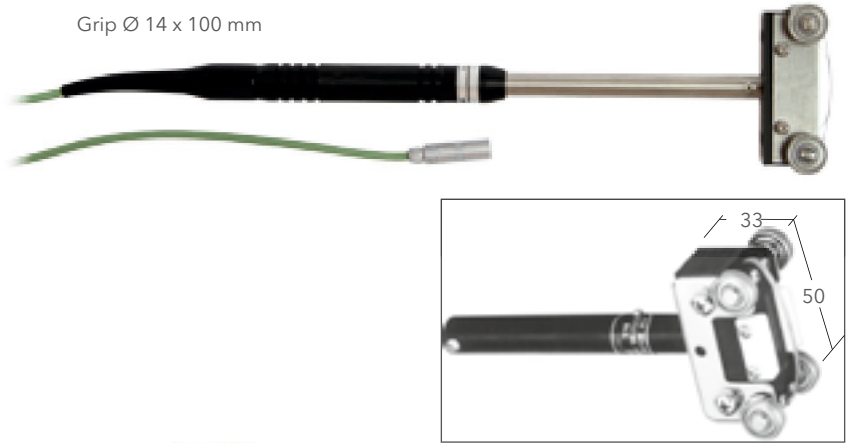

**TPN 801**

- same as TPN 800 but with SMP connection



Type	Description	Part No.
TPN 800	Rail probe with rollers and 1 m silicone cable, 33 x 50 mm measuring head,, Lemo	1341-0639
TPN 801	Rail probe with rollers and 1 m silicone cable, 33 x 50 mm measuring head, SMP	1343-0639

## High temperature probes

### Basic high temperature probes

*Temperature measurement on ingots (glowing metal blocks with high thermal capacity).*

#### TPN 1201

- Probe (Probe element: protected by stainless steel, with 1 m silicone cable)
- Range: -50 °C ... +1200 °C
- Accuracy: exceeds DIN IEC 584, class 2
- Response time ( $t_{99}$ ): 15 sec



Type	Description	Part No.
TPN 1201	High-temperature probe with 1 m silicone cable, up to +1200 °C, SMP	1343-0678

### Flexible high temperature probes

*High temperature measurement of air and gases.*

#### TPN 1220

- Probe (L = 1 m, Ø 2 mm, with Lemo connection)
- Flexible coated mantle thermocouple, mantle Ø 2 mm
- Thermopile: blank
- Range: -40 °C ... +1200 °C
- Accuracy: exceeds DIN IEC 584, class 1
- Response time ( $t_{99}$ ): 2.5 sec (water)



#### TPN 1221

- same as TPN 1220 but with SMP connection



Type	Description	Part No.
TPN 1220	Flexible high-temperature probe without cable, L = 1 m, Ø 2 mm, up to +1200 °C, Lemo	1341-0927
TPN 1221	Flexible high-temperature probe without cable, L = 1 m, Ø 2 mm, up to +1200 °C, SMP	1343-0927

## Other probes

### Thermal wire probes

*Measurement of air, oven and gas temperatures.*

#### TPN 600

- Probe (L = 1 m, outside 1.4 x 2.0 mm, Isolation: glass/silk meshwork, with Lemo connection)
- Range: -50 °C ... +400 °C
- Accuracy: exceeds DIN IEC 584, class 2
- Response time (t<sub>99</sub>, Air 0.2 m/s): 25 sec
- Approved to guideline 94/9 ATEX



#### TPN 601 same as TPN 600 but

- with SMP connection
- Without approval according to guideline 94/9 ATEX



#### TPN 610

- Probe (L = 1 m, outside 0.8 x 1.2 mm, Isolation: glass/silk meshwork, with Lemo connection)
- Range: -50 °C ... +400 °C
- Accuracy: exceeds DIN IEC 584, class 2
- Response time (t<sub>99</sub>, Air 0.2 m/s): 25 sec



#### TPN 601

- same as TPN 610 but with SMP connection



Type	Description	Part No.
TPN 600	Flexible thermal wire probe without cable, L = 1 m, outside 1.4 x 2.0 mm, Lemo	1341-0646
TPN 601	Flexible thermal wire probe without cable, L = 1 m, outside 1.4 x 2.0 mm, SMP	1343-0646
TPN 610	Flexible thermal wire probe without cable, L = 1 m, outside 0.8 x 1.2 mm, Lemo	1341-0800
TPN 611	Flexible thermal wire probe without cable, L = 1 m, outside 0.8 x 1.2 mm, SMP	1343-0800

## Penetration probes

Temperature measurement of viscoplastic masses such as asphalt, bitumen or grounds.

### TPN 220

- Probe (L = 100 mm, Ø 5 mm, stainless steel needle with tip, 1m silicone cable, with Lemo connection)
- Range: -200 °C ... +500 °C
- Accuracy: exceeds DIN IEC 584, class 2
- Response time ( $t_{99}$ ): 3.0 sec



### TPN 221

- same as TPN 220 but with SMP connection



### TPN 230

- Probe (L = 100 mm, Ø 2.1 mm, stainless steel needle with tip, 1m silicone cable, with Lemo connection)
- Range: -200 °C ... +500 °C
- Accuracy: exceeds DIN IEC 584, class 2
- Response time ( $t_{99}$ ): 2.5 sec
- Approved to guideline 94/9 ATEX



### TPN 231

- same as TPN 220 but with SMP connection



Type	Description	Part No.
TPN 220	Penetration probe with 1 m silicone cable, L = 100 mm, Ø 5 mm, -200 °C ... +500 °C, Lemo	1341-0664
TPN 221	Penetration probe with 1 m silicone cable, L = 100 mm, Ø 5 mm, -200 °C ... +500 °C, SMP	1343-0664
TPN 230	Penetration probe with 1 m silicone cable, L = 100 mm, Ø 2.1 mm, -200 °C ... +500 °C, Lemo	1341-0674
TPN 231	Penetration probe with 1 m silicone cable, L = 100 mm, Ø 2.1 mm, -200 °C ... +500 °C, SMP	1343-0674